

MCWP 2-21 (formerly MCWP 2-15.4)

Imagery Intelligence



U.S. Marine Corps

PCN 143 000088 00

MCCDC (C 42)
13 Jul 2004

E R R A T U M

to

MCWP 2-21

IMAGERY INTELLIGENCE

1. Change the publication short title to read "MCWP 2-21" (vice MCWP 2-15.4).

PCN 143 000088 80

DEPARTMENT OF THE NAVY
Headquarters United States Marine Corps
Washington, D.C. 20380-1775

6 September 2002

FOREWORD

Marine Corps Doctrinal Publication 2, *Intelligence*, and Marine Corps Warfighting Publication (MCWP) 2-1, *Intelligence Operations*, provide doctrine and higher order tactics, techniques, and procedures for intelligence operations. MCWP 2-15.4, *Imagery Intelligence*, complements and expands upon this information by detailing doctrine, tactics, techniques, and procedures for the conduct of imagery intelligence operations in support of the Marine air-ground task force (MAGTF). The primary target audience of this publication is intelligence personnel responsible for planning and execution of imagery intelligence operations. Personnel who provide support to imagery intelligence or who use results from these operations should also read this publication.

MCWP 2-15.4 describes aspects of imagery intelligence operations including doctrinal fundamentals, equipment, command and control, communications and information systems support, planning, execution, and training. MCWP 2-15.4 provides the information needed by Marines to understand, plan, and execute imagery intelligence operations in support of the MAGTF across the spectrum of conflict.

Reviewed and approved this date.

BY DIRECTION OF THE COMMANDANT OF THE MARINE CORPS

EDWARD HANLON, JR.
Lieutenant General, U.S. Marine Corps
Commanding General
Marine Corps Combat Development Command

Publication Control Number: 143 000088 00

IMAGERY INTELLIGENCE

TABLE OF CONTENTS

Chapter 1. Doctrinal Fundamentals

Overview	1-1
IMINT Information vs. Intelligence.....	1-1
Objectives of IMINT	1-2
Capabilities and Limitation of IMINT	1-2
Responsibilities and Products.....	1-2
Overview	1-2
Marine Corps IMINT Responsibilities.....	1-2
Types of IMINT Products	1-3
Related Terminology	1-4
Reconnaissance.....	1-4
Battlefield Surveillance	1-4
Point Target	1-4
National Imagery	1-4
Theater Imagery	1-5
Organic Imagery.....	1-5
IMINT vs. Imagery.....	1-5
Role and Functions.....	1-5
General	1-5
Tactical IMINT Principles	1-5
IMINT and the Intelligence Cycle	1-6
Planning and Direction.....	1-6
Collection	1-8
Processing and Exploitation.....	1-9
Production.....	1-9
Dissemination.....	1-9
Utilization.....	1-9
G-2/S-2 Role in the Intelligence Cycle	1-10
Levels of IMINT	1-10
National IMINT	1-10
Theater and Joint Task Force IMINT.....	1-11
Tactical IMINT.....	1-12

Chapter 2. Organizations and Responsibilities

MEF Key Personnel Responsibilities	2-1
The Role of the Commander	2-1
MEF Command Element G-2 Section and the Intel Bn	2-2
Other Command Element Staff	2-8
MEF Major Subordinate Commands' Intelligence Officers	2-9
National Imagery Organizations	2-9
Director of Central Intelligence	2-9
National Imagery and Mapping Agency	2-10
National Reconnaissance Office	2-10
Defense Intelligence Agency	2-11
Marine Corps Supporting Establishment Imagery Intelligence Organizations	2-11
Headquarters, U.S. Marine Corps	2-11
Marine Corps Combat Development Command	2-12
Marine Corps Systems Command	2-12
Marine Corps Intelligence Activity	2-12

Chapter 3. MAGTF IMINT Units and Organizations

Imagery Intelligence Platoon, Intelligence Battalion	3-1
Mission	3-1
Tasks	3-1
Organization	3-1
Command and Control	3-1
Concept of Employment	3-2
Miscellaneous	3-2
Joint Surveillance Target Attack Radar System Common Ground Station	3-4
Mission	3-4
Tasks	3-4
Organization	3-4
Command and Control	3-4
Concept of Employment	3-4
Miscellaneous	3-5
Direct Support Teams, Production and Analysis Company, Intelligence Battalion	3-5
Mission	3-5
Tasks	3-6
Organization	3-6
Command and Control	3-6
Concept of Employment	3-6
Miscellaneous	3-6
Marine Unmanned Aerial Vehicle Squadron	3-7
Mission	3-7
Tasks	3-7

Organization	3-7
Command and Control	3-7
Concept of Employment.	3-8
Miscellaneous.	3-8
Marine All-Weather Fighter Attack Squadron.	3-8
Mission	3-8
Tasks.	3-9
Organization	3-9
Command and Control	3-9
Concept of Employment.	3-9
Miscellaneous.	3-10
Marine Light/Attack Helicopter Squadron.	3-10
Mission	3-10
Tasks.	3-10
Organization	3-11
Command and Control	3-11
Concept of Employment.	3-11
Miscellaneous.	3-12
Ground Reconnaissance Units	3-13
Mission	3-13
Command and Control	3-13
Manpack SIDS Concept of Employment.	3-14
Tactical Intelligence Photographic Capability	3-15

Chapter 4 Imagery Intelligence Systems, C2 Nodes, Communications Information Systems, and Other Systems

Basic Imagery Intelligence Communications and Information Systems	
Requirements	4-1
Imagery Intelligence and Key Related Command and Control Nodes. . .	4-2
Organization	4-2
JTF J-2 and the Joint Intelligence Support Element.	4-6
Amphibious Forces.	4-7
MEF Command Element	4-8
Imagery Intelligence Information Systems and Supporting	
Communications.	4-13
Imagery Direction and Collection Management.	4-13
Imagery Collection.	4-16
Imagery Processing, Exploitation, and Production Capabilities . . .	4-21
Imagery CIS Architecture.	4-25
IMINT Communications and Information Systems Planning	
Considerations	4-25

Chapter 5. Operational Planning and Execution

Marine Corps Planning Process	5-1
Mission Analysis	5-1
COA Development.	5-2

COA Wargaming	5-2
COA Comparison and Decision	5-2
Orders Development	5-2
Transition	5-2
Joint Planning Processes	5-2
Joint Deliberate Planning	5-2
Crisis Action Planning	5-2
Planning and Imagery Intelligence	5-4
Planning and Intelligence Cycle	5-4
Basic IMINT Planning Process	5-4
Planning Responsibilities	5-7
Intelligence Officer	5-7
Intelligence Battalion Commander/Detachment OIC	5-7
General Planning Considerations	5-7
Principles	5-7
Concept of Operations	5-8
Terrain	5-8
Weather	5-8
Threat	5-9
Specific Planning Considerations and Execution Activities	5-9
Planning and Direction	5-9
Collection	5-10
Processing and Exploitation	5-20
Production	5-21
IMINT Utilization	5-27
IMINT Operations Appendix	5-28
IMINT Plans within Other Portions of Annex B	5-28
Appendix 11 (Intelligence Estimate)	5-28
Appendix 14 (Reconnaissance and Surveillance Plan)	5-29
Appendix 16 (Intelligence Operations Plan)	5-30
Appendix 17 (Support to Survival, Evasion, Resistance, and Escape)	5-31

Appendices

A	Imaging Sensors	A-1
B	National Imagery Interpretability Rating Scale	B-1
C	Request Formats for Aerial Imagery Collection Missions.....	C-1
D	Unmanned Aerial Vehicle Squadron Equipment and Performance Characteristics	D-1
E	MAGTF Imagery Intelligence Planning Checklist.....	E-1
F	Imagery Intelligence Report Formats.....	F-1
G	Imagery Intelligence Support to Intelligence Studies	G-1
H	Imagery and Supporting Intelligence Reports	H-1
I	Imagery Intelligence Target Folders	I-1
J	National Imagery Transmission Format Compression.....	J-1
K	Imagery Intelligence Appendix Format	K-1
L	Unmanned Aerial Vehicle Plan Format	L-1
M	Aerial Imagery Plan Format	M-1
N	Glossary	N-1
O	References and Related Publications	O-1

CHAPTER 1. FUNDAMENTALS

If you can't get behind enemy lines and peer around with your own good eyes, what's your next best bet? A photograph, isn't it?

—FMFRP 12-16, *Front Line Intelligence*

Imagery is the representation of objects reproduced electronically or by optical means on film, electronic display devices or other media.

Imagery, along with the graphical, geospatial, and textual intelligence products derived from it, is an increasingly critical element in the planning and decisionmaking efforts of commanders and supporting staffs at all echelons. Much of the imagery available to the Marine air-ground task force (MAGTF) commander requires detailed analysis by highly trained specialists to fully exploit its value. Imagery and imagery-related information—when processed, exploited, analyzed, and fused with other intelligence information—results in imagery intelligence (IMINT).

Principal sources of imagery and related data are national overhead intelligence systems such as satellites; manned aircraft such as the F-14 or F/A-18 with the advanced tactical airborne reconnaissance system (ATARS); the U-2 and the joint surveillance target attack radar system (JSTARS); unmanned aerial vehicles (UAVs); and various hand-held cameras.

Overview

IMINT Information vs. Intelligence

A critical distinction must be made when discussing, planning for, and executing IMINT operations and operations yielding imagery-related combat information. IMINT is the function performed by the G-2/S-2 that involves

imagery analysis and integration with other intelligence activities to produce all-source intelligence products. The intelligence battalion's (intel bn's) imagery intelligence platoon (IIP), unit intelligence personnel, and Marine Corps Intelligence Activity (MCIA) conduct IMINT operations, planning, collecting, producing, and disseminating information or intelligence to the commander, staff, and major subordinate commands (MSCs). To provide imagery analysis for fusion into intelligence, specifically trained technical personnel, adequate time, and sophisticated equipment are required. Imagery and related combat and sensor data from JSTARS, UAVs, and various reconnaissance sources with hand-held cameras may sometimes be rapidly disseminated to tactical commanders to effect decisions without extensive intelligence processing and analysis. This type of intelligence support is provided directly to the tactical commander without being analyzed or evaluated against other intelligence. Caution should be exercised to ensure that the commander is apprised of the strong potential for misleading information when the provided intelligence is based on a single, unevaluated intelligence source.

IMINT aids commanders and planners primarily through two forms of support. First, IMINT provides situational awareness for the terrain, both natural and manmade, to support the commander's intelligence preparation of the battlespace (IPB) effort through various baseline IMINT and geographic intelligence (GEOINT) based studies such as helicopter landing zones (HLZs); beach, coastal, port and airfield studies; and gridded reference graphics (GRG). Second, support is provided through imagery as a confirming source of intelligence for another discipline such as signals intelligence (SIGINT) or human intelligence (HUMINT).

Objectives of IMINT

Reduce Uncertainty

IMINT must support the commander's decision-making process by reducing uncertainty about the hostile situation and the surrounding environment.

Counterintelligence and Force Protection

IMINT supports the identification of hostile intelligence collection operations; aids with the identification of MAGTF vulnerabilities that could be exploited by the enemy; and assists with the evaluation of friendly security measures to counter these.

Capabilities and Limitations of IMINT

Capabilities

IMINT is an extremely valuable part of intelligence. IMINT provides concrete, detailed, and precise information on the location and physical characteristics of both the threat and the environment. It is the primary source of information concerning key terrain features, installations, and infrastructure used to build detailed intelligence studies, reports, and target materials. Order of battle (OOB) analysis, enemy courses of action assessments, development of target intelligence, and battle damage assessment (BDA) are intelligence functions that rely heavily upon IMINT.

Limitations

The major limitations of IMINT are the time required to task, collect, process, analyze, and disseminate the imagery product; the detailed planning and coordination required to ensure the collected imagery is received in time to impact the decisionmaking process; and the requirement for considerable assets in personnel, equipment, and communications connectivity to conduct IMINT operations. Also, imagery operations can be hampered by weather; enemy air defense capability; and enemy camouflage, cover, concealment and deception activities.

Sensors

Appendix A describes the basic capabilities and limitations of electro-optical (EO), radar, and infrared imagery sensors.

Responsibilities and Products

Overview

The Marine Corps relies on a complementary mix of tactical, theater, and national IMINT sources to support its intelligence planning and operations. The MAGTF must use the full range of US intelligence capabilities, from national through theater to organic, in support of the assigned mission. Due to the nature of expeditionary operations, the employment of organic MAGTF intelligence collection assets within the assigned area of operations (AO) is not feasible until just prior to the introduction of forces. This means that national or theater intelligence assets must be relied upon for predeployment IMINT support.

The MAGTF will rely almost exclusively on external support during the planning and deployment phases of any operation. Even when employed, the MAGTF will continue to require national and theater support in specific areas to add depth to the reconnaissance effort and cover gaps in organic collection capabilities.

Marine Corps IMINT Responsibilities

The MAGTF G-2/S-2 has staff responsibility for intelligence, counterintelligence (CI), and reconnaissance, to include support of IMINT operations. In conjunction with the G-3/S-3, the G-2/S-2 develops the intelligence operations plan (appendix 16 to annex B), the supporting IMINT plan (appendix 7 to annex B), and the reconnaissance and surveillance (R&S) plan (appendix 14 to annex B), which allocate resources and assign specific imagery reconnaissance and supporting missions to MAGTF and supporting elements. Together, these intelligence plans assign intelligence missions,

reconnaissance missions, and tasks, and also allocate supporting resources.

Factors affecting the development of intelligence and supporting IMINT plans are—

- Priority intelligence requirements (PIR) and intelligence requirements, to include the specific intelligence questions to be answered for each.
- Communications connectivity and information systems capabilities available, both in IMINT units as well as in supported commands.
- Time available.
- Available information and intelligence from other sources.
- Redundancy required.
- Assets available.
- Knowledge of the enemy situation.
- Enemy counter-reconnaissance capabilities.

Based on these factors, the commander's intent, anticipated enemy activity, the MAGTF concept of operations, and the overall intelligence operations plan, the G-2/S-2 develops specific intelligence, reconnaissance, and imagery-related tasks. Individual units are assigned reconnaissance tasks per the intelligence plan. The intelligence support coordinator (ISC), under the staff cognizance of the MAGTF G-2/S-2, establishes an intelligence operations center (IOC) to perform intelligence requirements management, staff cognizance of ongoing organic and supporting collection operations, intelligence production and analysis, and intelligence dissemination. The following are the key elements within the IOC:

- **Support Cell.** Primary element for conducting Marine expeditionary force (MEF)-wide intelligence requirements management; weather support; collections and dissemination planning and direction; and intelligence staff cognizance of MEF organic and supporting intelligence and reconnaissance operations.
- **Surveillance and Reconnaissance Cell (SARC).** Primary element for supervising the execution of

organic and supporting intelligence and reconnaissance plans.

- **Production and Analysis (P&A) Cell.** Primary production and analysis element of the MAGTF. Processes and produces all-source intelligence products in response to requirements of the MAGTF. Additionally, principal IMINT and GEOINT production element of the MEF.

MAGTF subordinate units also conduct intelligence and reconnaissance planning and operations in support of their own efforts through a variety of means. Close coordination with the ISC and IOC is essential to ensure overall effective MAGTF intelligence operations and intelligence support to all commanders. IMINT and imagery-related data and information are collected by a variety of assets, each with unique capabilities and limitations. The following MAGTF units and organizations are those most likely to be tasked with imagery-related collection missions and production support:

- Imagery intelligence platoon, intel bn.
- Marine unmanned aerial vehicle squadrons (VMUs).
- JSTARS common ground station (CGS).
- Marine fighter/attack (all weather) squadrons (VMFA[AW]s) F/A-18D.
- Marine light/attack helicopter squadron (HML/A).
- Ground reconnaissance units with Manpack secondary imagery dissemination system (SIDS) or tactical intelligence photographic (TACPHOTO) capability.

Types of IMINT Products

Major types of IMINT products include IMINT reports, hard copy prints, mosaics, overlays, annotated photographs, and various hard copy and electronic all-source intelligence products. See chapter 5 for a detailed discussion of imagery and IMINT products.

Related Terminology

Reconnaissance

A reconnaissance mission is undertaken to obtain, by visual observation or other detection methods, information about the activities and resources of an enemy or potential enemy, or to secure data concerning the meteorological, hydrographic, or geographic characteristics of a particular area. (JP 1-02)

Broad Area Coverage, Broad Area Search, and Directed Search Area

These imaging strategies provide a reconnaissance capability to cover large areas of the earth's surface. These techniques are especially suited for providing large area coverage for baseline studies of terrain and lines of communication. On the negative side, they take extended time to produce large format mosaic prints, are normally produced at a low National Imagery Interpretation Rating Scale (NIIRS) rating, and possess imagery quality of only fair to poor (see appendix B for a discussion of NIIRS).

Broad area coverage (BAC), also known as broad area search (BAS), are missions entailing imagery coverage of large areas of the earth's surface that enable analysis of a greater amount of area and provide the imagery needed for the creation of large area mosaics.

Directed search area (DSA) imagery missions identify a geographic region in the shape of a polygon that may contain from 3 to 24 corner points with latitude and longitude coordinates. This gives intelligence planners the flexibility to tailor intelligence collection and other operations plans to meet commanders' needs.

Route Reconnaissance or Lines of Communications Coverage

This imagery coverage is defined by a road, mobility corridor or other form of transportation

passageway delineated by a specific start and end point. This type of reconnaissance is not limited to enemy areas but may be requested to facilitate friendly logistics or troop movements. The image product is normally produced as a variation of a standard mosaic, a strip map or as a GRG.

Battlefield Surveillance

Battlefield surveillance is the systematic observation of the battle area to provide timely information and combat intelligence. The primary difference between reconnaissance and surveillance is that reconnaissance is normally a single "look" while surveillance denotes a continuous observation. Surveillance is not normally considered a capability of the imagery process, with the exception of JSTARS and UAVs. Both the JSTARS and UAV platforms have endurance limitations that do allow for the long-term continuous observation often required for operational support.

Point Target

A point target is a specified imaging target that is normally less than 1 nautical mile in diameter. It is meant for higher resolution imagery such as EO NIIRS (see appendix B for a discussion of NIIRS) of 5.0 or better to provide the clarity of detail required for specific equipment identification or for precision targeting solutions. This type of target is best suited for static/semistatic targets that will require detailed analysis to answer specific PIR and intelligence requirements (IRs). Point targets are the most common technique used in imagery collection operations.

National Imagery

National imagery refers to imagery platforms under the control of a US Government agency such as the National Imagery and Mapping Agency (NIMA). These platforms normally consist of imagery satellites used for military operations, treaty verification, mapping, and foreign humanitarian assistance.

Theater Imagery

Theater imagery refers to the imagery platforms under the cognizance of the theater combatant commander. These may include airborne platforms such as the U-2, high altitude or extended endurance UAVs, and F-14 tactical aerial reconnaissance pod system (TARPS).

Organic Imagery

Organic imagery refers to all other types of imagery platforms organic to or under the control of the MAGTF commander. These platforms range from hand-held cameras with ground reconnaissance teams to F/A-18D ATARS aircraft.

IMINT vs. Imagery

IMINT is fully analyzed and evaluated imagery and supporting detailed intelligence text reports (which may also include information from other intelligence disciplines such as SIGINT), whereas imagery consists of the raw, unevaluated pictures of an area or target. An annotated target graphic represents IMINT while either the on-screen picture or prints from the screen of a downlinked UAV represent imagery in an unevaluated form.

Role and Functions

General

IMINT and other intelligence disciplines provide information regarding the enemy and the battlespace (weather and terrain) that help the commanders reduce uncertainty; identify opportunities for success; assess risk; outline their intent; make decisions that provide focus, generate speed, and tempo; and achieve decisive results.

IMINT provides MAGTF commanders operational and tactical intelligence support. Imagery and IMINT contribute to all six specific intelligence functions: support to the commander's estimate, situation development, indications and warning (I&W), force protection, targeting, and combat assessment. Specifically, IMINT assists intelligence personnel by providing commanders with I&W of hostile action; IPB; identification of enemy disposition, location, and strength; situational development to confirm or deny enemy intentions and courses of action; and BDA to allow continual assessment of the effectiveness of friendly attacks and their effects on enemy strengths, vulnerabilities, and capabilities.

Tactical IMINT Principles

Focus on Tactical Intelligence

National and theater imagery assets support the strategic and operational levels of war as well as tactical operations. MAGTF IMINT operations focus on the generation of tactical intelligence and utilization of strategic/operational IMINT for tactical purposes. However, consideration should always be given to required timelines for processing, exploitation, production, and dissemination of imagery and IMINT products in relation to the MAGTF operational tempo when selecting an imagery system to provide tactical support. For example, a theater system may not be able to tailor imagery or IMINT in the format required of the battle area in a timely enough manner to support tactical I&W decisions.

Intelligence is Focused Downward

While the management of IMINT collection and production is centralized in the MAGTF command element (CE), the focus is on providing imagery support needed to plan and execute the mission to every unit involved in the operation.

Critical products will be pushed down to the tactical commander, who will be able to pull additional IMINT support as needed.

Intelligence Activities Require Centralized Management

Scarcity of IMINT assets, the broad geographic range and operational capabilities, and the requirement to focus IMINT resources on the commander's PIR require centralized coordination and management. This centralization will be done in the MAGTF IOC, under the direction of the intel bn commander as the ISC. Although centralized management is generally required to best plan and use IMINT resources, mission, enemy, terrain and weather, troops and support available-time available (METT-T) may require the MAGTF commander to either attach or place task-organized IMINT elements in direct support of MAGTF subordinate elements to satisfy their IRs.

G-2/S-2 Facilitates Utilization of Intelligence

The intelligence officer enables effective utilization of IMINT and all other intelligence and reconnaissance activities and products throughout the unit. As the principal disseminator of intelligence and a full and continuous participant in the planning process, the intelligence officer ensures that the full implications of the IMINT and overall intelligence picture are understood. This and the full intelligence operations mission are accomplished through three key subordinate officers. The first, the G-2 operations officer, is responsible for the provision and effective use of intelligence to the commanding general, the battlestaff, the current and future operations sections, and force fires. The second, the G-2 plans officer, is responsible for this support to the future plans team. Finally, the third is the intel bn commander as the assistant chief of staff (AC/S) G-2's ISC, having principal staff responsibility for the timely dissemination of intelligence throughout the MAGTF and ensuring it is understood, complete, and if any new IRs result from it.

Tailored and Timely Intelligence

Intelligence tailored to the requirements of the user provide a useful format, effect the development of pertinent IMINT and all-source intelligence products, and thus support decisionmaking. Dissemination of these intelligence products—not simply data, pictures or information—to the right place at the right time is the guiding principle of all intelligence dissemination activities.

Utilization: The Final Step

IMINT's value is derived from its support of decisionmaking. The IMINT intelligence cycle is not complete until the IMINT that has been developed is used to plan and/or execute operations. Central to this principle is the need for intelligence personnel to ensure that disseminated IMINT and other intelligence products have been received by all needing it; that they understand it; the degree to which it satisfies their previously stated IRs; and whether it leads to new IRs.

IMINT and the Intelligence Cycle

The IMINT cycle mirrors the intelligence cycle (see figure 1-1). These steps define both a sequential and an interdependent process for developing IMINT. These steps differ from the joint intelligence cycle in its emphasis on utilization of intelligence. Imagery-related data and intelligence should be passed directly to the appropriate user—depending upon the situation, either an intelligence command and control (C2) node or directly to commanders—to meet the requirement for rapid action related to the demands of current and future operations.

Planning and Direction

Planning and directing MAGTF IMINT operations includes:

- Determining IMINT intelligence collection requirements (ICRs) intelligence production requirements (IPRs), and intelligence dissemination requirements (IDRs).

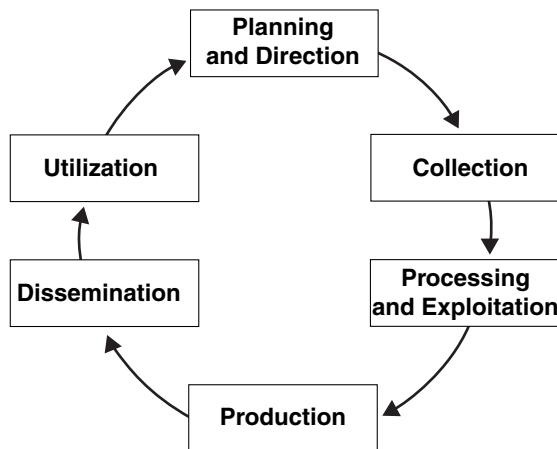

Figure 1-1. The Intelligence Cycle.

- Reviewing on-hand/accessible all-source and IMINT products and databases to see if the needed intelligence is available.
- Planning supporting collection, production, and dissemination efforts for validated requirements.
- Issuing orders and requests to IMINT and all-source agencies.
- Integrating and coordinating intelligence operations with maneuver, fires, communications and information systems (CIS) and combat service support (CSS).
- Supervising to assess the productivity of these agencies to determine if PIRs and IRs are being satisfied, and to rapidly respond to changing battlespace conditions, modifying old or initiating new IMINT orders and operations as appropriate.

The core nodes for all MAGTF intelligence planning are the G-2 plans branch within the MEF G-2 section for intelligence support to future plans; the G-2 operations branch for intelligence support to the current and future operations cells; and the support cell within the IOC established by the intelligence battalion, under the direction of the ISC, for all detailed internal and supporting intelligence and reconnaissance planning.

Effectively identifying IMINT requirements is critical to successful IMINT operations. This is true for several reasons. IMINT operations are only successful if integrated intelligence planning and direction, collection and production management, exploitation, and dissemination functions are effectively accomplished, and especially since generally limited imagery collection and production assets are available. Finally, each and every IMINT requirement requires a well-planned and potentially different technology mix of tools, significant computing power, and technically qualified personnel.

Stating IMINT requirements well is the best way to improve a unit's chances of satisfying their imagery-related intelligence requirement.

Requests for imagery support are submitted via the chain of command using the Joint Tactical Air Reconnaissance/Surveillance (JTAR/S) format shown in appendix C. These will be processed in the IOC by the ISC in coordination with the G-2 operations officer and the G-2 air officer. Requests for imagery must include the following:

Mission

State what must be accomplished, such as finding unlocated enemy forces, distinguishing certain types of tanks, assessing the status of a bridge, etc.

Type of Target

Most MAGTF tactical IMINT requirements will be for point targets of 10 nautical miles or less. Broad area search requirements are taxing in terms of communications bandwidth requirements and man-hours; and should be avoided unless absolutely necessary.

Date Desired

Date desired (DATEDES) is the date-time-group of when the requester requires either the imagery or the IMINT product.

Latest Time Intelligence Is of Value

The latest time intelligence is of value (LTIOV) is the time by which information must be delivered to the requestor in order to provide decision-makers with timely intelligence.

Intelligence Requirements

The requester must identify the specific IRs associated with the imagery/IMINT request. This should also include a statement as to the preferred format/method and quantity for the desired intelligence products.

It is critical that commanders and nonintelligence planners understand what is required of them when stating an IMINT requirement. The following actions are necessary to ensure that IMINT requirements are effectively articulated to intelligence planners, collectors, producers, and disseminators:

- State clearly what is wanted to obtain from the imagery, what specifically it will be used to support, and when you anticipate these actions to occur.

Example

I want to be able to clearly identify all obstacles on both approaches to the bridge across river X located at point Y to move tracked and wheeled vehicles across the bridge during the period 14-17 Oct 2000.

- State your DATEDES, which is the date and time you require the imagery or IMINT product be provided to you. This provides IMINT planners with a way of prioritizing their missions, especially when there are limited assets available. This also allows intelligence personnel the option of providing a partial or lower quality product by the DATEDES and using the limited assets for an operation in the execution phase.

Example

DATEDES is 1200 14 Oct 00 to support planning and briefing.

- State your LTIOV and what it will support. It is critical that the user carefully considers the date

and time submitted as LTIOV, because if IMINT planners cannot meet the LTIOV, the request will be rejected.

Example

LTIOV 0500 15 Oct 00, 1 hour prior to the estimated crossing of the line of departure.

Note: IMINT and intelligence planners must notify supported commanders immediately once it is identified that a LTIOV cannot be met, and that their IMINT requirement will not be supported.

- State the format you desire and at least one acceptable alternative for the IMINT products to be produced. If you have any specific requirements such as specific annotation, state that as well.

Example

Request that a finished imagery product be posted in JPEG format on the MEF imagery homepage accessible via either the MAGTF tactical data network (TDN) or SIPRNET. Request standard annotation set. Acceptable alternate format is hard copy print (10 each) in 11x17 inch format.

Collection

Collection is defined as the gathering of intelligence data and information to satisfy identified validated IRs. Within the MAGTF, collection management is a function of the collection management and dissemination (CMD) section that is established during operations within the IOC support cell. For IMINT, the collection phase of the intelligence cycle is complete when the imagery information and data are provided to the processing and production elements in the P&A cell. Imagery collectors available to support the MAGTF may be manned/unmanned, airborne/ground-based, systems or sensors that can operate across the MAGTF areas of interest in day or night, all-weather conditions. The IOC may substitute or supplement organic capabilities by receiving photographic, EO, infrared, radar/multispectral imagery, and IMINT from national, theater, other

Services, host country, embassy team sources, and other multinational allies.

Processing and Exploitation

Processing and exploitation involves the conversion of collected data into information suitable for the production of intelligence. Imagery processing for IMINT purposes refers to the conversion/transformation of exposed film or electronic photographic, EO, infrared, and radar imagery into a form usable for interpretation and analysis. Softcopy imagery is manipulated electronically, internal to a processing/production system. Imagery exploitation by the IIP's imagery analysts is driven by specified PIR and IRs and allows the MAGTF to gain the fullest possible advantage derived from imagery data by identifying specific pieces of equipment, measuring the dimensions of structures found on an image, identifying potential targets, assessing BDA and I&W factors, and otherwise producing IMINT from imagery data.

Production

Production is the activity that converts information into intelligence through the integration, analysis, evaluation, and interpretation of all-source data and the preparation of intelligence products in support of known or anticipated user requirements. IMINT production refers to writing imagery reports; annotating imagery products; creating imagery-derived products; integrating and fusing IMINT into all-source intelligence products; and identifying new or remaining intelligence gaps requiring follow-on intelligence collection or production support. Most IMINT production is accomplished by the IIP, while the P&A cell within the IOC is the principal producer of all-source intelligence products.

Dissemination

Dissemination is the timely conveyance of intelligence to users in a suitable form. The ISC, per

the direction and guidance of the AC/S G-2, has principal responsibility for intelligence dissemination within the MEF. The ISC must identify intelligence reporting criteria for both routine and time-sensitive intelligence, determine the forms/formats to be used, and then select the means for delivering intelligence and IMINT products to all supported commanders. For example, intelligence reporting criteria will provide imagery collectors and IMINT producers necessary guidance for when data and products will be delivered to intelligence production or C2 nodes, and when these will be disseminated directly to commanders. Formats selected may be text, graphics or other intelligence products depending upon a variety of factors (available time, capabilities of users, etc.). Further, IMINT operations must be planned and coordinated with supporting MAGTF CIS and courier operations to ensure IMINT products can be delivered or transmitted to users in a timely manner. The core nodes for intelligence dissemination execution are the IOC support cell, and the G-2 section watch within the MEF's current operations center (COC).

Utilization

The commander is responsible for the effective use of intelligence for decisionmaking purposes. Utilization of intelligence for decisionmaking during planning and execution is the ultimate objective of intelligence. The G-2/S-2 facilitates the effective use of intelligence, and thus of IMINT, by supervising the entire intelligence development effort and assisting the commander and staff in understanding intelligence products and their application. Additionally, the utilization phase provides the basis for the continuous functioning of the intelligence and supporting IMINT cycles. It will determine whether IRs have been completely satisfied; those that have not will then require additional intelligence development effort. Finally, as some IRs are satisfied, new ones will be generated. In all cases, utilization provides guidance, feedback, and orders for subsequent intelligence and IMINT operations.

G-2/S-2 Role in the Intelligence Cycle

Figure 1-2 depicts the G-2/S-2 role in the intelligence cycle and highlights that IMINT is one of the capabilities needed to support overall MAGTF intelligence requirements and operations. Since IRs are numerous, complex, and challenging, no single intelligence discipline, source or sensor can provide all of the required data and intelligence in the correct usable format. Some specific data must be processed and all of the seemingly unrelated, individual pieces of information must be evaluated, analyzed, and integrated into a usable, fused, all-source intelligence product that satisfies the commander's operational information needs.

national imagery and IMINT sources to support planning and operations (see figure 1-3). External imagery support is particularly important in viewing denied areas and assisting the MAGTF in pre-deployment planning and imagery archive development. As the MAGTF moves towards an AO, imagery support is provided by a mix of national, theater, and other Services' assets. Once a MAGTF is within the AO, its organic assets will take on greater importance and provide significant imagery support; however, support is still required from external assets to broaden the commander's view.

Levels of IMINT

MAGTFs rely on a complementary mix of tactical, joint, theater, other Services, and

National IMINT

National IMINT is extremely valuable for MAGTF purposes, particularly in the early phases of MAGTF operational planning and for viewing denied areas. MAGTF requirements for national IMINT support are submitted via the operational chain of command to the Defense Intelligence Agency (DIA) for ultimate validation,

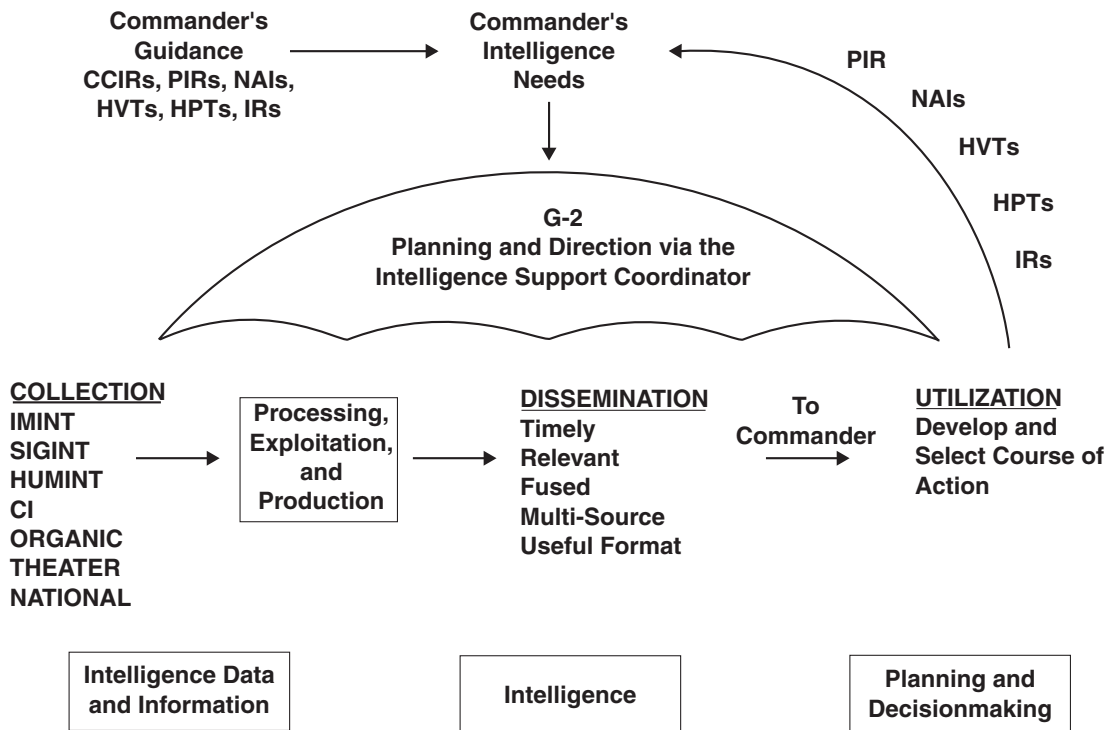
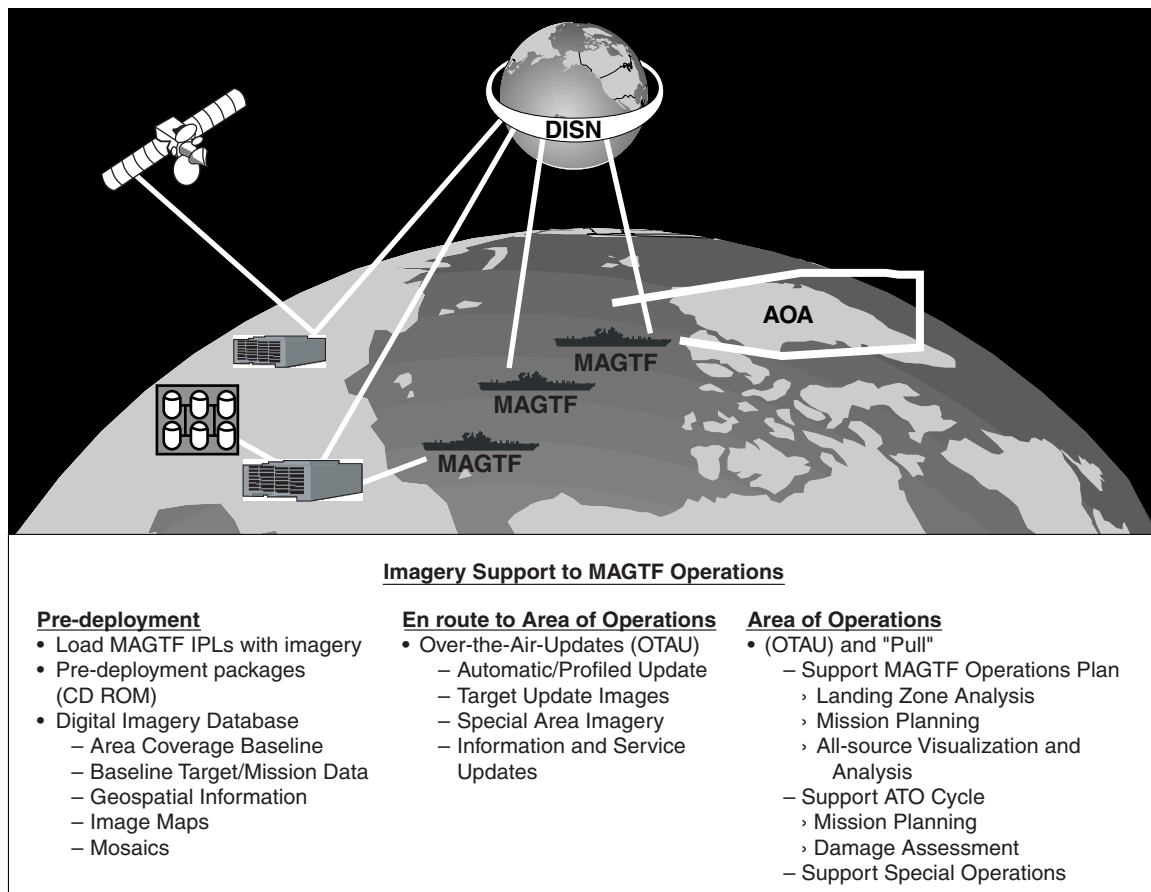

Figure 1-2. G-2/S-2 Role in the Intelligence Cycle.



A goal of imagery architecture development is to ensure that imagery products are available to support the MAGTF during all phases of the operation, regardless of geographic location.

Figure 1-3. External Imagery Support Request Chain.

prioritization, and coordination with pertinent elements of the national imagery community (see figure 1-4 on page 1-12). National imagery reconnaissance assets, when available, can be very responsive when at least a 6-hour lead-time exists. The passive nature of most national IMINT collection operations has the advantage of requiring minimal coordination efforts by the MAGTF beyond the initial nomination, validation, and forwarding of the imagery request. Planning time over target (TOT) parameters for most joint force air component commander (JFACC) operations is 72 hours, with aviation combat element (ACE) mission planners generally operating on a 48-hour cycle; Marine expeditionary unit (special operations capable) (MEU[SOC]) ACE and squadron level mission

planners typically operate on a cycle of 24 hours or less. (Specific technical and operational capabilities and procedures for most national IMINT resources are classified; refer to either the *Joint Tactical Exploitation of National Systems* manual or theater tactics, techniques, and procedures (TTP) for additional information.)

Theater and Joint Task Force IMINT

Theater combatant commanders play a significant role in imagery support to MAGTFs because of the critical requirement for component interoperability during joint operations. Joint and theater IMINT is provided by the combatant command’s organic imagery assets, such as the JSTARS, U-2, and theater UAVs. Combatant commands, through

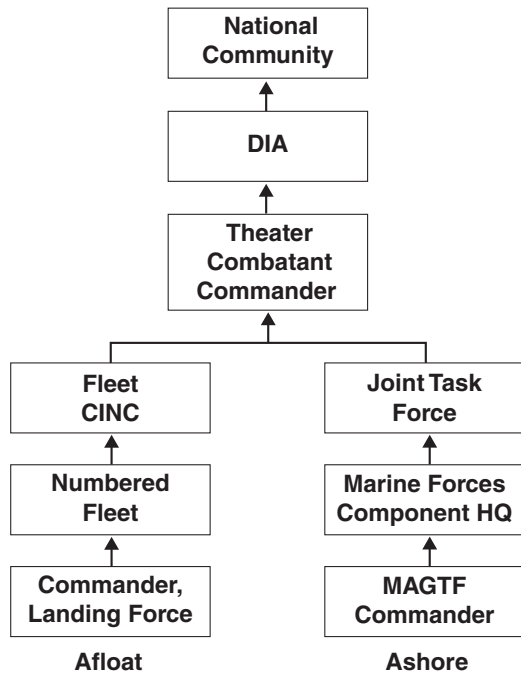

Figure 1-4. External Imagery Support Request Chain.

their joint intelligence centers and joint analysis centers, meet operational IMINIT requirements of component, subordinate intelligence centers, and joint task forces (JTFs).

Tactical IMINT

MAGTF Tactical IMINT

MAGTF tactical IMINT operations include intelligence derived from the collection, processing, exploitation, production, and dissemination of imagery derived from organic collectors (e.g., F/A-18 with ATARS), as well as imagery collected by national or theater collectors but exploited, tailored to MAGTF requirements, and fused into all-source intelligence products, and then disseminated

throughout the MAGTF from the IOC. Organic collectors of imagery and imagery-related information, such as UAVs and hand-held cameras, can provide both routine and time-sensitive tactical intelligence. Because MAGTFs are task-organized, their organic capabilities and the degree of external support they require may vary. Forward-deployed MEU(SOC) engaged in forward presence missions normally have only a nucleus of imagery analysts (military occupational specialty [MOS] 0241) providing support within the CE's intelligence section and rely heavily upon external support to fulfill their imagery needs. A MEF with its significant organic imagery capability will need to rely less on external support. In either situation, a MAGTF must plan for a tailored combination of organic, joint, theater, and national imagery that meets the MAGTF's needs for imagery support. Chapters 3 and 4 address current and planned Marine Corps imagery organizations and capabilities available as organic to MAGTFs.

Amphibious Force IMINT

Landing force (LF) and amphibious task force (ATF) intelligence officers collaboratively execute ATF and LF IMINT operations. The organic IMINT capabilities of the ATF and LF are generally limited, necessitating reliance for IMINT support from secondary imagery dissemination from fleet intelligence organizations. A key IMINT resource is the three F-14 Tomcats configured with the TARPS in one of two F-14 Squadrons assigned to each carrier battle group (CVBG). TARPS has two optical sensors (day-only) and one day/night infrared imagery sensor. Navy imagery specialists exploit the film-based TARPS imagery and provide either IMINT reports or actual images to the MAGTF.

CHAPTER 2. ORGANIZATIONS AND RESPONSIBILITIES

A man trusts his ears less than his eyes.

— *Herodotus, 484-424 B.C.*

Developing the imagery capabilities and executing the IMINT operations to satisfy the wide variety of MAGTF requirements are extremely difficult challenges that require extensive cooperation and coordination among all members of the intelligence community—MAGTF, other Services, joint, and national. This chapter addresses the major roles and responsibilities of various IMINT-related organizations and key personnel within the operating forces and supporting establishment of the Marine Corps, as well as those external to the Corps.

MEF Key Personnel Responsibilities

The Role of the Commander

Command Attention

Intelligence is an inherent and essential responsibility of command. Command attention is critical to military success. The commander must ensure that members of the unit understand the importance placed on intelligence and the requirement to support the intelligence effort. The commander's involvement in the intelligence process encompasses focusing the intelligence effort, participating in the intelligence process, using intelligence in decisionmaking, supporting the intelligence effort, and providing personal evaluation of the intelligence effort.

Intelligence Requirements

The commander focuses intelligence and supporting IMINT efforts through articulation of

commander's intent and planning guidance and identification of PIRs. These drive all resulting intelligence collection, production, and dissemination activities.

Resource Allocation

A detailed and well thought out concept of intelligence support, developed in accordance with the commander's intent and concept of operations, will provide appropriate allocation of intelligence capabilities between the MAGTF's main and supporting efforts, and between intelligence support to current operations and the continuous planning efforts for future operations. IMINT resources are limited; trained imagery analysts—as well as IMINT collection, processing, and dissemination assets—compete with nonintelligence missions for their use. Some MAGTF imagery collection assets, such as the F/A-18 ATARS and UAVs, have multimission roles and may be tasked with command and control, targeting, other intelligence, electronic warfare, or other missions in addition to imagery collection. For IMINT operations, therefore, the commander's role in mission prioritization of organic imagery airborne collection and other IMINT assets is particularly important.

Communications and Information Systems Support

The extent to which a MAGTF can request and receive JTF, theater, and national imagery support is a function of the level and effectiveness of its CIS connectivity and throughput capability from the tactical through the theater and national levels. The commander must assess CIS intelligence needs against all competing MAGTF CIS requirements to ensure necessary support is provided.

MEF Command Element G-2 Section and the Intel Bn

Assistant Chief of Staff, G-2

The AC/S G-2 has staff responsibility for intelligence and intelligence operations, to include IMINT (see figures 2-1 and 2-2). The commander relies on the intelligence officer to provide the necessary information on the weather, terrain, and enemy capabilities, status, and intentions.

Through the intelligence operations plan and supporting intelligence and R&S plans, the MEF AC/S G-2 validates and plans IRs; coordinates intelligence priorities; integrates collection, production and dissemination activities; allocates resources; assigns specific intelligence and reconnaissance missions to subordinate elements; and supervises the IMINT and overall intelligence and reconnaissance efforts. Specific all-source and key IMINT responsibilities include:

- Developing and answering outstanding MEF and subordinate units' PIR and IRs by planning, directing, integrating, and supervising organic IMINT and multidiscipline MEF and supporting intelligence operations.
- Preparing appropriate IMINT and other intelligence and reconnaissance plans and orders for the MEF, and reviewing and coordinating the IMINT and all-source intelligence plans of JTFs, theaters, and other organizations.
- Submitting and coordinating all-source and IMINT collection, production, and dissemination requirements beyond the capability of the MEF to satisfy to higher headquarters for JTF, theater or national IMINT systems support.
- Ensuring IMINT and other intelligence information is rapidly processed, analyzed, incorporated (where appropriate in all-source intelligence products), and rapidly disseminated to all MEF and external units requiring these.

- Evaluating JTF, theater, and national IMINT and all-source intelligence support and adjusting stated IRs, if necessary.
- Identifying and correcting deficiencies in IMINT and other intelligence and reconnaissance personnel and equipment resources.
- Incorporating exercise IMINT in training exercises to improve MEF individual, collective, and unit readiness.
- Facilitating understanding and use of IMINT and other intelligence in support of the planning and execution of MEF operations.

G-2 Operations Officer

The G-2 operations officer, under direction of the MEF AC/S G-2, has primary responsibility for intelligence support to the commanding general (CG) and the remainder of the MEF CE in support of current and future operations.

Specific all-source and key IMINT related duties include:

- Coordinating and providing intelligence support (to include key IMINT support) to the CG, the G-3 operations section, and the remaining MEF CE's battlestaff.
- Serving as G-2 representative to the MEF CE crisis action team (CAT).
- Coordinating, providing, and supervising intelligence support to the MEF CE COC, future operations center (FOC), and force fires.
- Planning, directing, and supervising the threat or red cell.
- Providing recommendations on PIR and IR validation, prioritization, and taskings to the AC/S G-2 and the ISC.
- Coordinating and supervising the transition of intelligence planning and operations from G-2 plans to G-2 future operations, and from G-2 future operations to G-2 current operations, to effectively support the MEF's single battle transition process.

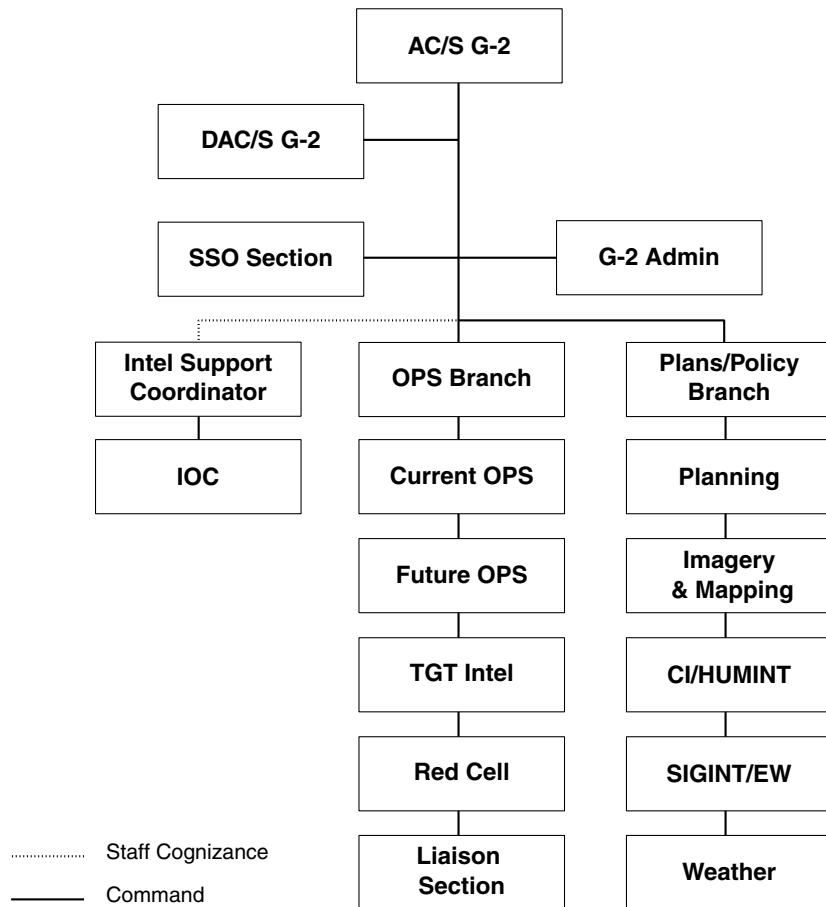

Figure 2-1. MEF G-2 Division Principal Staff Officers and Relationships.

- Planning, directing, and supervising MEF liaison teams to external commands (e.g., the JTF and joint functional components headquarters) and intelligence organizations.
- Coordinating with the ISC and MEF MSCs’ G-2 operations officers to ensure unity of effort of MEF intelligence operations.
- Providing intelligence input and other support to MEF warning and fragmentary orders and to operations related reporting (e.g., periodic situation reports).
- Coordinating intelligence training for the MEF G-2 section and providing G-2 oversight for and integration of the MEF intelligence training program.
- Accomplishing other intelligence support and tasks as directed by the AC/S G-2.

G-2 Plans Officer

The G-2 plans officer, under the direction of the MEF AC/S G-2, has primary responsibility for intelligence support to the MEF CE’s future plans cell. Specific all-source and key IMINT related duties include:

- Planning the MEF concept of intelligence operations for approval by the AC/S G-2 and subsequent implementation by the ISC based upon the mission, threat, commander’s intent, guidance, and concept of operations. This concept of intelligence operations includes a supporting IMINT concept of operations.
- Leading, coordinating, and providing intelligence support to the MEF G-5 future plans section.

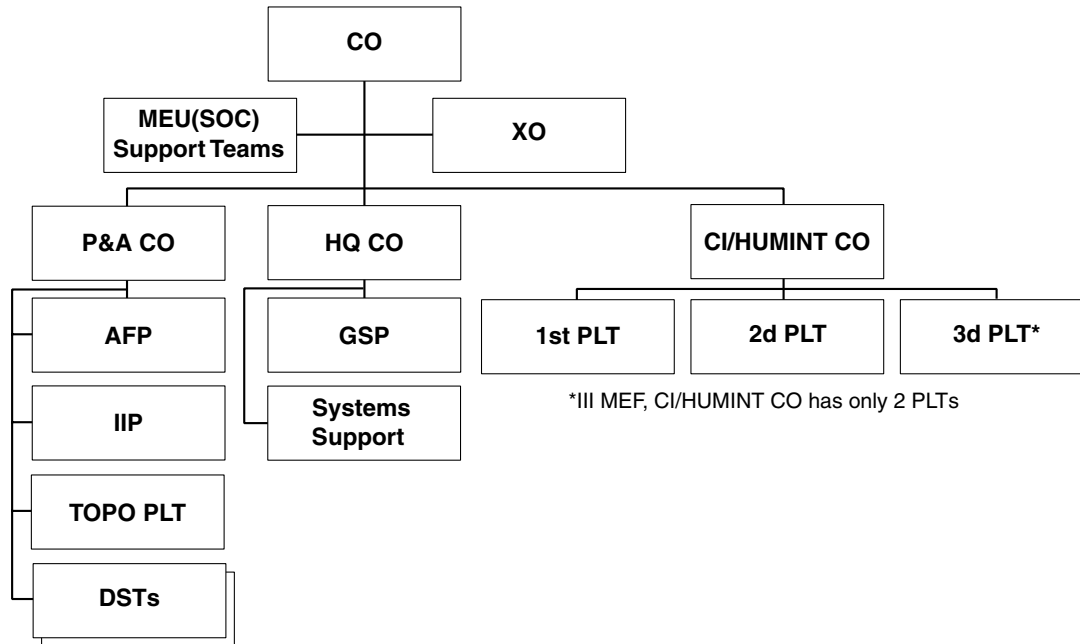

Figure 2-2. Intelligence Battalion.

- Planning and coordinating intelligence support requirements for and the deployment of intelligence elements and resources into the AO.
- Providing recommendations on PIR and IR validation, prioritization, and taskings to the AC/S G-2 and the ISC.
- Coordinating with the ISC, G-2 development of Annex B (Intelligence) and Annex M (Geospatial Information and Services) to MEF operation plans (OPLAN), their supporting appendices (such as the appendix 7, Imagery Intelligence), and all intelligence input to other annexes of OPLANs.
- Keeping the G-2 section, other CE staff sections, intelligence liaison personnel, augmentees, and others apprised of MEF intelligence planning actions and requirements.
- Identifying requirements and providing recommendations to the G-2 operations officer for MEF intelligence liaison teams to external commands (e.g., the JTF or other components' headquarters) and intelligence agencies.
- Coordinating and developing policies for MEF intelligence, CI, and reconnaissance operations.
- Planning, directing, and supervising the MEF G-2's imagery and mapping, CI/HUMINT, SIGINT, and weather sections.
- Accomplishing other intelligence support and tasks as directed by the AC/S G-2/S-2.

***Intel Bn Commander/
Intelligence Support Coordinator***

The intel bn commander is responsible for planning and directing, collecting, processing, producing and disseminating intelligence, and providing CI support to the MEF, MEF MSCs, subordinate MAGTFs, and other commands as directed.

Garrison. The principal task of the intel bn commander in garrison is to organize, train, and equip detachments that support MAGTFs or other designated commands to execute integrated collection, intelligence analysis, production, and dissemination of intelligence products.

Actual Operations. During operations, the intel bn commander is dual-hatted as the ISC, serving as such under the direct staff cognizance of the MEF AC/S G-2. The intel bn's S-3 section, along with the

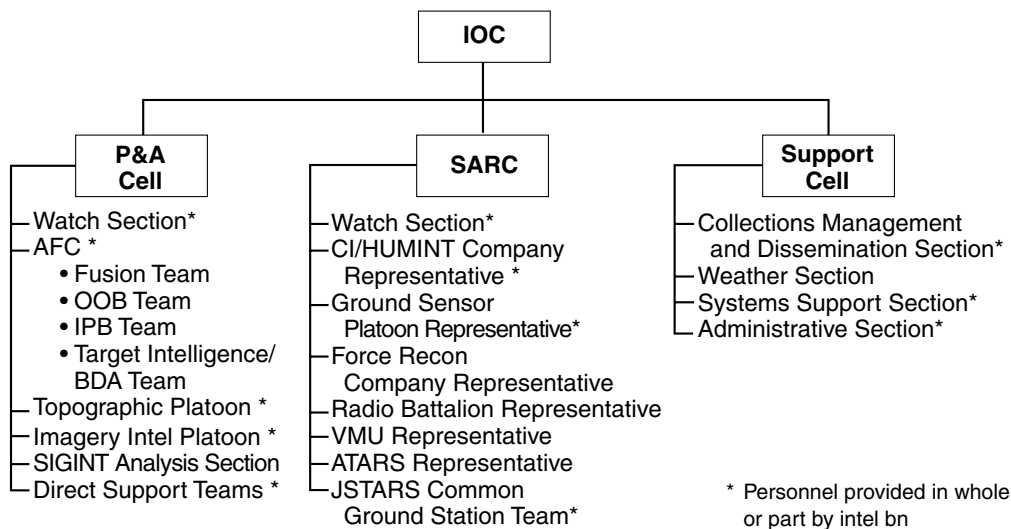

Figure 2-3. Intelligence Operations Center.

operations center element of the MEF G-2, forms the core of the ISC support effort, with planning, direction, and C2 conducted within the IOC's support cell. As the ISC, the commander is responsible to the MEF AC/S G-2 for the overall planning and execution of MEF all-source intelligence operations. Specific all-source and key IMINT responsibilities of the ISC during actual operations include:

- Implementing the concept of intelligence operations (and the supporting IMINT concept of operations) developed by the G-2 plans officer and approved by the AC/S G-2.
- Establishing and supervising operation of the MEF IOC, which includes the support cell, the SARC, and the P&A cell (see figure 2-3). Generally, the IOC will be collocated with the MEF CE's main command post.
- Developing, consolidating, validating, and prioritizing recommended PIR and IRs to support MAGTF planning and operations.
- Planning, developing, integrating, and coordinating MEF intelligence collection, production, and dissemination plans, to include the effective organic and external integration and employment of MAGTF IMINT as well as staff cognizance of MEF SIGINT, CI, HUMINT, GEOINT, ground remote sensors, ground reconnaissance, and tactical air reconnaissance

intelligence collections, production, and dissemination operations.

- Developing and completing, with the G-2 plans officer and G-2 operations officer, Annex B (Intelligence) and Annex M (Geospatial Information and Services) to MEF operation orders (OPORDs), their supporting appendices (such as appendix 7, Imagery Intelligence), and all intelligence input to other annexes of OPORDs.
- Planning, developing, integrating, and coordinating intelligence and CI support for the commander's estimate, situation development, indications and warning, force protection, targeting, and combat assessment.
- Managing and fusing the threat (or red) common operational picture (COP)/common tactical picture (CTP) inputs from subordinate units and external commands and intelligence agencies into the MEF CE's threat COP/CTP.
- Providing intelligence support to the MEF CE G-2 section and the MSCs.
- Preparing the intelligence and CI estimates to support G-2 plans.
- Planning, developing, and coordinating intelligence communications and information systems architecture, to include its integration with and support of MEF IMINT and other intelligence and reconnaissance requirements.

- Coordinating and integrating MEF IMINT and all-source intelligence operations with other service components, JTF joint intelligence support element (JISE), theater joint intelligence center (JIC) or joint analysis center (JAC), and national intelligence agencies and operations (e.g., NIMA), to include all aspects of intelligence reachback support.
- Assisting with the evaluation and improvement of MEF IMINT and all-source intelligence operations.
- Accomplishing other intelligence support and tasks as directed by the AC/S G-2.

(See table 2-1 for the principal responsibilities of the AC/S G-2's three principal staff subordinate officers.)

Collection Management/Dissemination Officer

The collection management/dissemination officer (CMDO) is sourced from the intel bn's S-3 section and is a key subordinate to the intel bn commander/ISC during operations. The CMDO is responsible for formulating detailed ICRs and IDRs and tasking and coordinating internal and external operations to satisfy these. The CMDO receives validated PIR and IRs and direction from the ISC, and then plans and manages the

best methods to employ organic and supporting collection and dissemination resources through the intelligence collection and dissemination plans (tabs to Appendix 16, Intelligence Operations Plan, to Annex B), which includes all IMINT collection and dissemination activities. The CMDO is also responsible for validating and forwarding national and theater IMINT and other collection requests from the MEF and MSCs typically using appropriate intelligence tools and TTP. The CMDO also is responsible for coordinating intelligence CIS requirements and maintaining awareness of available CIS connectivity throughout the MAGTF and with key external organizations. During operations, the CMDO works within the support cell.

In coordination with the P&A cell officer in charge (OIC), the SARC OIC, G-2 operations officer, IMINT-related unit commanding officers (COs)/OICs, and the MEF G-6, the CMDO is responsible to the ISC for the following IMINT-related tasks. Determining and coordinating the collection effort of PIR/IRs that may be collected via imagery (ATARS, UAVs, national imagery databases) and supporting resources (i.e., force reconnaissance company) Determining of PIR/IRs and preparing requests for intelligence that are beyond organic capabilities and

Table 2-1. AC/S G-2's Principal Subordinate Staff Officers and Responsibilities.

ISC	G-2 Operations Officer	G-2 Plans Officer
Planning and execution of intelligence operations to support all MEF IRs.	Providing intelligence support to MEF CE battle staff and current operations center agencies.	Providing intelligence support to the plans officer's future planning team for future planning IRs.
Establishing and directing the IOC (P&A cell, SARC, and support cell).	Coordinating intelligence support to higher and adjacent headquarters and agencies.	Recommending IR validation, prioritization, and tasking to AC/S G-2.
Managing IRs (collection, production, and dissemination), validating, prioritizing, and tasking IRs, per AC/S G-2 direction.	Recommending IR validation, prioritization, and tasking to AC/S G-2.	Establishing and directing the G-2 future planning intelligence element.
Exercising C2 of intel bn and staff cognizance over SIGINT, CI, HUMINT, measurement and signature intelligence, IMINT, and air and ground reconnaissance, including staff cognizance of designated G-2 elements.	Establishing and directing intelligence elements and support to the combat operations center, future operations center, target intelligence section, force fires, red cell, and MEF intelligence liaison teams.	Establishing and operating the intelligence section's imagery and mapping, CI, HUMINT, SIGINT, and weather sections (less that under staff cognizance of the ISC).

preparing submissions to higher headquarters and external agencies for support.

- Recommending dissemination priorities, development of intelligence reporting criteria, and advising on and selecting dissemination means.
- Developing and coordinating IMINT and all-source intelligence collection plans, coordinating and integrating these with MEF, other components, JTF, theater, and national intelligence production operations.
- Developing and coordinating IMINT and all-source intelligence dissemination plans and supporting architectures for both voice and data networked communications, and coordinating and integrating these with MEF, other components, JTF, theater, and national intelligence CIS and dissemination operations.
- Monitoring the flow of IMINT throughout the MAGTF and ensuring that it is delivered to intended recipients in a timely fashion and satisfactorily meets their needs.
- Evaluating the effectiveness of MEF and supporting IMINT collection and dissemination operations.

SARC OIC

The SARC OIC is the second immediate subordinate of the ISC and supervises the execution of the integrated organic, attached, and direct support intelligence collection and reconnaissance operations. The SARC OIC is responsible to the ISC for accomplishing the following specific IMINT-related responsibilities.

- Coordinating, monitoring, and maintaining the status of all ongoing imagery collection operations. This includes—
 - Missions, tasked ICRs, and reporting criteria for collection missions.
 - Locations and times for all pertinent fire support control measures.
 - Primary and alternate CIS plans for both routine and time-sensitive requirements, for

IMINT collectors as well as between the collectors or the SARC and key MEF CE and MSC C2 nodes, to support ongoing C2 of IMINT collection operations and dissemination of acquired data and intelligence to those needing it via the most expeditious means.

- Conducting detailed IMINT collection planning and coordination with the MSCs and IMINT organizations planners, with emphasis on ensuring understanding of the collection plan and specified intelligence reporting criteria.
- Ensuring other MAGTF C2 nodes (e.g., the current operations center, force fires, etc.) are apprised of ongoing IMINT and other intelligence and reconnaissance operations.
- Receiving routine and time-sensitive IMINT-related reports from deployed collection elements; cross-cueing among intelligence collectors, as appropriate; and the rapid dissemination of IMINT reports to MAGTF C2 nodes and others in accordance with standing PIR/IRs, intelligence reporting criteria and dissemination plan, and the current tactical situation.

Production and Analysis Cell OIC

The P&A cell OIC is the third principal subordinate to the ISC, with primary responsibility for managing and supervising MEF all-source intelligence processing and production efforts, to include all aspects of IMINT production. Key all-source and IMINT-related responsibilities include:

- Planning, directing, and managing operations of the all-source fusion platoon (to include the fusion, OOB, IPB, and target intelligence/BDA teams), the topographic platoon (topo plt), the IIP, the direct support teams (DSTs), and other P&A elements as directed.
- Coordinating and integrating P&A cell operations, estimates and products with the MEF G-2 section's G-2 operations branch and its red cell operations and estimates.
- Maintaining all-source automated intelligence databases, files, workbooks, country studies, and other intelligence studies.

- Planning and maintaining imagery, mapping, and topographic resources and other intelligence references.
- Administering, integrating, operating, and maintaining intelligence processing and production systems, both unclassified general service (GENSER) and sensitive compartmented information (SCI) systems (e.g., the image product library [IPL], joint deployable intelligence support system [JDISS], intelligence analysis system [IAS]).
- Analyzing and fusing IMINT with other intelligence into tailored all-source intelligence products to satisfy all supported commanders' stated or anticipated PIRs and IRs.
- Developing and maintaining current and future intelligence situational, threat, and environmental assessments and target intelligence based upon all-source analysis, interpretation, and integration.
- Managing and fusing the threat COP/CTP inputs from subordinate units and external commands and intelligence agencies into the MEF CE's threat COP/CTP.

IIP Commander/Detachment OIC

The IIP commander is responsible for planning and providing the MEF, and other commands as directed, with imagery and imagery analysis to support operations. Specific tasks include:

- Exploiting and analyzing all-source, multisensor imagery to derive intelligence pertaining to installations, dispositions, strengths, and activities of various conventional and nonconventional forces.
- Employing imagery methods and techniques in the planning and tasking of multisensor platforms, both those organic and external to the MAGTF.
- Conducting imagery exploitation and assisting in imagery management.

- Providing IMINT reports, limited imagery-derived products, and secondary imagery to the MEF and other commanders.
- Conducting liaison with the MCIA for obtaining imagery products in support of MEF intelligence requirements.
- Administering and managing the MEF IPL.

Other Command Element Staff

G-1

The G-1 is responsible for all personnel requirements with regard to the IMINT effort. MEF IMINT requirements may require personnel augmentation to satisfy all requirements. All requests for IMINT personnel augmentation will be developed by the MEF G-2 and provided to the G-1 for either internal sourcing or forwarding to higher headquarters for action (e.g., global sourcing).

G-3

The G-3 is responsible for planning, coordinating, and supervising the tactical employment of units. As such, the movement and operations of IMINT and supporting units must be coordinated by the G-2 with the G-3 for integration in future and current operations planning. Since some imagery supporting units also provide certain nonintelligence capabilities, close coordination between the G-2 and G-3 is necessary for mission prioritization and deconfliction. The G-3 has primary responsibility for the planning and operations of maneuver and fires, and is typically a principal staff user of IMINT, requiring close coordination throughout the planning process to ensure effective IMINT support. Accordingly, G-3 personnel must understand the capabilities of the different IMINT collection systems and exploitation and advantages and limitations of different types of imagery and IMINT products to form realistic expectations of IMINT support, to effectively and efficiently request appropriate support, and to integrate intelligence into operations.

G-4

The G-4 is responsible for the logistic support of attached IMINT units. To ensure the required support is available, arrangements should be developed early in the deployment that meet the particular needs of the deployed IMINT-supported unit. Special attention is drawn to logistics requirements of IMINT units' unique and sometimes sizable equipment (e.g., IIP).

G-5

The G-5 is the principal staff officer responsible for all long-range (future) planning and joint planning matters. Normally, a G-5 is found only at the MEF and Marine Corps forces (MARFOR) levels; at lower MEF echelons future planning is the responsibility of the G-3. The G-5 understanding of imagery/IMINT and the type of support required parallels that of the G-3.

G-6

The G-6 provides for and protects CIS connectivity and operations, both within and external to the MEF. This includes providing the communication paths, network accesses, and frequencies for IMINT organizations organic, attached to and/or supporting the command, which requires significant systems knowledge across IMINT and all-source intelligence CIS.

MEF Major Subordinate Commands' Intelligence Officers

The MSC intelligence officers must understand imagery, IMINT, and their capabilities and uses. Additionally, MSC intelligence officers must be able to articulate in detail all IMINT requests they submit through the chain of command and integrate IMINT support with other command intelligence and reconnaissance operations. Because IMINT resources are generally limited, MSC intelligence officers must recognize that their units' IMINT requirements will compete

with all others from throughout the MAGTF. Close coordination among all unit intelligence officers will identify opportunities where small adjustments to IMINT requirements result in satisfying more than one unit's requirement during the same collection and/or production tasks.

Key MSC intelligence officers' IMINT tasks can include:

- Planning and implementing a concept for intelligence support based on the mission, concept of operations, and commander's intent.
- Providing centralized direction for command intelligence operations, to include IMINT elements attached to or placed in direct support of the unit.
- Consolidating, validating, and prioritizing unit IRs and IMINT needs.
- Submitting consolidated requests for external IMINT support to the MEF CE.
- Coordinating operational and CIS links to pertinent supporting external IMINT collection and production elements and operations.
- Providing timely, accurate feedback on the level of unit satisfaction regarding IMINT support received.

National Imagery Organizations

Director of Central Intelligence

The Director of Central Intelligence (DCI) is responsible for the procurement, operation, and management of national imaging systems and programs that support activities from the level of the President and/or the Secretary of Defense to forward deployed MAGTFs.

The DCI's imagery responsibilities cover all phases of the intelligence cycle including direction, collection, processing, production, and dissemination. Responsibility also includes determining current and future requirements, developing imagery-related systems, and establishing security procedures.

To fulfill IMINT-related responsibilities, the DCI has established a network of committees, subcommittees, working groups, and panels composed of representatives from national organizations, Department of Defense (DOD) agencies, and Military Services. The Marine Corps is represented on the DCI's imagery-related committees to ensure Marine Corps support requirements are identified and incorporated at the national level. These national efforts affect both current and future operations. In the near term, this Marine Corps representation maximizes programmatic support for developing new imagery systems and strategies that will provide critical support to MAGTF operations.

National Imagery and Mapping Agency

NIMA is designated a DOD Combat Support Agency. Specified tasks of the NIMA director can include:

- Organizing, directing, and managing NIMA resources.
 - Planning, coordinating, and managing the tasking of national IMINT collection operations in support of military operations.
 - Providing advisory tasking for theater and tactical IMINT assets, including advising imagery collection elements on collection of imagery to meet national intelligence requirements when collection elements are assigned to or under the operational control of the secretary of a Military Department or the commander of a combatant command, and not allowed by the Secretary of Defense to meet national intelligence requirements.
 - Providing and managing imagery and geospatial production and analysis.
 - Disseminating imagery, IMINT, and geospatial information by the most efficient, expeditious, and secure means available.
- Developing and making recommendations on national and non-national policy for imagery and geospatial intelligence.
 - Developing and coordinating DOD and intelligence community systems and technical standards.

NIMA's Marine Corps Customer Support Team is the focal point for Marine Corps customer support and provides the point of accountability through which requirements are identified and needs are met. Key IMINT tasks include:

- Understanding and coordinating NIMA resources to support Marine Corps needs.
- Assessing, defining, tasking, and coordinating Marine Corps needs into IMINT production actions.
- Providing single point of accountability to the Marine Corps for requirements satisfaction.
- Prioritizing Marine Corps needs into NIMA business plans.
- Managing execution of Marine Corps programs approved for development.
- Measuring Marine Corps satisfaction with NIMA IMINT programs.
- Providing feedback on the status of Marine Corps IMINT production requirements.
- Providing IMINT production expertise to Marine operating forces.

National Reconnaissance Office

The mission of the National Reconnaissance Office (NRO) is to enable US global information superiority. The NRO is responsible for the unique and innovative technology, large-scale systems engineering, development and acquisition, and operation of space reconnaissance systems—to include critical imagery resources—and related intelligence activities needed to support

global information superiority. Its capabilities include support to I&W, monitoring arms control agreements, and support to military operations. The NRO accomplishes its mission through the on-going research and development, acquisition, and operation of spaceborne and airborne intelligence systems. NRO assets and capabilities may be tasked to support MAGTF operations under procedures described in the Joint Tactical Exploitation of National Systems manual.

Defense Intelligence Agency

DIA is a primary coordinator of several departmental imagery programs and activities that contribute to the development and operations of imagery capabilities and IMINT activities. DIA coordinates the Services' and combatant commands' imagery and IMINT requirements; manages centralized DOD collection and production management requirements programs (e.g., requirements for multispectral imagery); coordinates operational and technical interoperability requirements for intelligence dissemination (e.g., by setting data standard formats for secondary imagery dissemination systems); and sponsors and participates in numerous imagery working groups, programs, and panels to address imagery and IMINT capabilities issues. Additionally, DIA coordinates and manages National Intelligence Support Team (NIST) support to joint operations. The NIST is a deployable intelligence team comprised of special intelligence planning, CIS, and analytical support, to include national IMINT support. NIST composition may include elements from DIA, the National Security Agency (NSA), the Central Intelligence Agency (CIA), and NIMA.

Marine Corps Supporting Establishment Imagery Intelligence Organizations

The Commandant of the Marine Corps (CMC) is directly responsible for the internal organization, training, efficiency, and readiness of the Marine

Corps; for the operation of its material support system; and for the total performance of the Marine Corps.

Various Marine Corps supporting establishment organizations are staffed with personnel carrying out responsibilities pertaining to IMINT and imagery-related matters. Major organizations are listed below.

Headquarters, U.S. Marine Corps

Intelligence Department

Imagery Plans and Policies Branch

The Marine Corps Director of Intelligence implements those CMC responsibilities as they relate to IMINT and other imagery matters through the Imagery and Geospatial Plans and Policy Branch. Specific imagery and IMINT-related tasks include:

- Developing Marine Corps plans and policies for IMINT.
- Validating Marine Corps requirements for national imagery collection, production, and dissemination of imagery and all-source intelligence products. As the Marine Corps Departmental Requirements Officer (DRO), Imagery and Geospatial Plans and Policy is the final service validation and adjudication authority for all USMC national imagery and IMINT requests submitted through the service (vice operational) chain of command.
- Executing duties as the Marine Corps national imagery community representative on numerous DOD and intelligence community committees, subcommittees, working groups, and panels.
- Advising NIMA on matters pertaining to Marine Corps imagery capabilities and limitations in a joint and multinational environment.
- Coordinating with Marine Corps Combat Development Command (MCCDC) and Marine Corps Systems Command (MARCORSYSCOM) on matters related to IMINT doctrine, organization, training and education, equipment, and support combat capabilities development.

Aviation Department

The Deputy Commandant for Aviation, Headquarters, Marine Corps (HQMC) Aviation Department (AVN), coordinates closely with Navy aviation elements for procurement of manned and unmanned tactical aviation platforms and sensors. In this capacity, critical IMINT programs, such as ATARS and UAV, fall under AVN cognizance.

Marine Corps Combat Development Command

The mission of MCCDC is to develop Marine Corps warfighting concepts and to determine associated required capabilities in the areas of doctrine, organization, training and education, equipment and support facilities to enable the Marine Corps to field combat-ready forces; and participate in and support other major processes of the Combat Development System.

Marine Corps Systems Command

MARCORSYSCOM plans and manages research, development, and acquisition programs through equipment production and fielding for employment

by MAGTF forces, to include most imagery and IMINT supporting equipment programs (e.g., SIDS).

Marine Corps Intelligence Activity

The Marine Corps maintains a Service-level intelligence capability within MCIA. MCIA provides tailored intelligence and services that support HQMC; develops Marine Corps doctrine, force structure, force modernization, training and education, acquisition policy and programming; and Marine Corps forces contingency planning and other requirements for intelligence products not satisfied by theater, other Service or national research and analysis capabilities. MCIA focuses on crisis and predeployment support to expeditionary warfare. It complements the efforts of theater, other Services, and national intelligence organizations and provides unique all-source threat, technical, and GEOINT products tailored to Marine Corps operating forces needs. It also coordinates Marine Corps Service imagery collection, production, and dissemination requirements by acting as the Marine Corps Service IMINT collection, production, and dissemination manager, to include taskings of the USMC Reserve's IIP. MCIA is collocated with the National Maritime Intelligence Center (NMIC), Suitland, MD, and at Marine Corps Base, Quantico, VA.

CHAPTER 3. MAGTF IMINT UNITS AND ORGANIZATIONS

Within the Marine Corps, units responsible for the conduct of tactical IMINT are the IIPs, intelligence direct support teams, VMUs, VMFA(AW)s, and ground reconnaissance elements. This chapter describes these units' missions, tasks, organization, and concepts of employment.

Imagery Intelligence Platoon, Intelligence Battalion

Mission

The mission of the IIP is to provide imagery analysis and IMINT support to MAGTFs and other commands as directed.

Tasks

- Exploit and analyze all-source, multisensor imagery to derive intelligence pertaining to installations, dispositions, strengths, and activities of various conventional and nonconventional forces.
- Employ imagery methods and techniques in the planning and tasking of multisensor platforms, organic and external to the MEF or supported MAGTF.
- Conduct exploitation and assist in imagery management.
- Provide IMINT reports, limited imagery-derived products, and secondary imagery to the MEF and other commanders.
- Conduct liaison with the MCIA for the purpose of obtaining imagery products in support of MEF or supported commander's IRs.

Organization

Each MEF has one organic IIP. It is a subordinate unit of the P&A company, intel bn. Each IIP is

organized into three elements: a platoon headquarters, two tactical imagery analysis sections, and three imagery analysis teams (see figure 3-1).

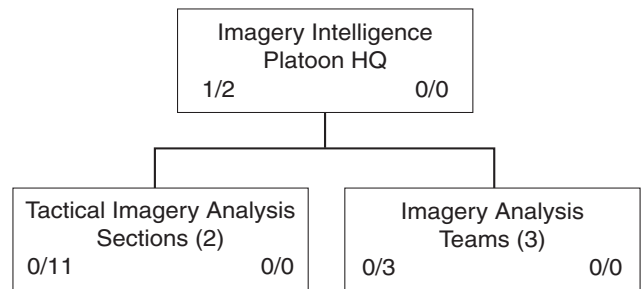

Figure 3-1. IIP Organization.

The 4th Imagery Interpretation Unit (IIU) is in the Reserves. It is organized into a headquarters section, four imagery teams, and a general intelligence support team. It is OPCON to Marine Corps Forces Reserve and ADCON to Marine Air Control Squadron 23. A memorandum of understanding exists that enables the MCIA to task and coordinate 4th IIU imagery exploitation, production, and training support of operating forces requirements.

Command and Control

The IIP is a subordinate unit of the intel bn, with the intel bn commander maintaining full command of its operations. When supporting smaller MAGTFs, the IIP or its detachments will operate under the C2 of either the intel detachment OIC or the supported unit's G-2/S-2.

MEF CE Staff Cognizance

The MEF commander usually exercises C2 over the intel bn elements, to include the IIP, via the MEF intelligence officer. The ISC performs this

function, however, under the staff cognizance of the AC/S G-2.

The ISC in turn exercises C2 of topo plt via the P&A cell OIC. This allows for the centralized direction and effective integration of IIP operations with other MEF IMINT operations and the broader all-source intelligence concept of operations.

Support Relationships

General Support. The IIP will typically operate in general support of the MEF. Under general support, the MEF commander, through the G-2 and the ISC, determines priorities of intelligence collections and production support, locations of IMINT support nodes, and IMINT and all-source intelligence dissemination.

Direct Support and Attached. Depending upon METT-T considerations, the IIP or task-organized imagery analysis detachments from it may be employed in direct support of or attached to a particular unit or MSC of the MEF. In such cases the scope of the supported commander's C2 authority over assigned IIP elements will usually be specified to ensure effective support to operations while allowing the MEF commander to maintain effective C2 of broader intelligence and IMINT operations. Direct support or attachment may consist of dedicated imagery exploitation support, placement of IIP assets with the supported unit, or simply establishing an IMINT node to provide direct dissemination of imagery and IMINT to the supported unit's intelligence section or COC. In the latter relationship, an IIP liaison element should be provided to the supported unit and continuing relationships between IMINT elements and supported units should be established whenever possible.

Concept of Employment

An IIP is capable of supporting one MEF. In support of a Marine Expeditionary Brigade (MEB), MEU(SOC) or other MAGTF, a task-organized imagery analysis detachment may be attached to the MAGTF CE either independently or as part of

a larger intel bn detachment. (Some operations may require the activation of X/C-coded billets or global sourcing from other IIPs.)

The reserve 4th IIU conducts peacetime training and production activities in garrison at Buckley Air National Guard Base, Aurora, CO. All IIP production activities support Marine Corps operating forces' OPLAN intelligence requirements. The 4th IIU is capable of providing 24-hour contingency support on-site or providing limited personnel for active duty support.

During MEF operations, the operation of the tactical exploitation group (TEG) will be a focal point of IIP support (see figure 3-2). Each IIP in the operating force will have one TEG. It is packaged in three high mobility, multipurpose wheeled vehicles (HMMWVs). The TEG has the capability to receive, exploit, and produce imagery and IMINT products and reports in support of MAGTF requirements. As such, it will be interoperable with EO, infrared, and radar imagery from ATARS-equipped USMC F/A-18D; the synthetic aperture radar (SAR) system (ASARS-2) aboard the U-2R/U-2S; and with the MCIA, combatant command JICs, and other imagery platforms and organizations. Additionally, the TEG provides the capability to exploit film-based imagery and output from digital cameras and various aircraft heads-up displays/forward-looking infrared (FLIR) and gun camera tapes. Once received and processed/exploited, the imagery is then transmitted over available SIDS device(s) or via other CIS means. Exploited imagery from the TEG may then be hosted on the IPL server located with the IIP, from which MEF users can pull images to support future IRs.

Miscellaneous

Communications and Information Systems

The IIP has sufficient communications resources to support internal and detachment C2 requirements. The IIP will require access to various networks to conduct its operations, to include the SECRET Internet Protocol Router Network (SIPRNET), the

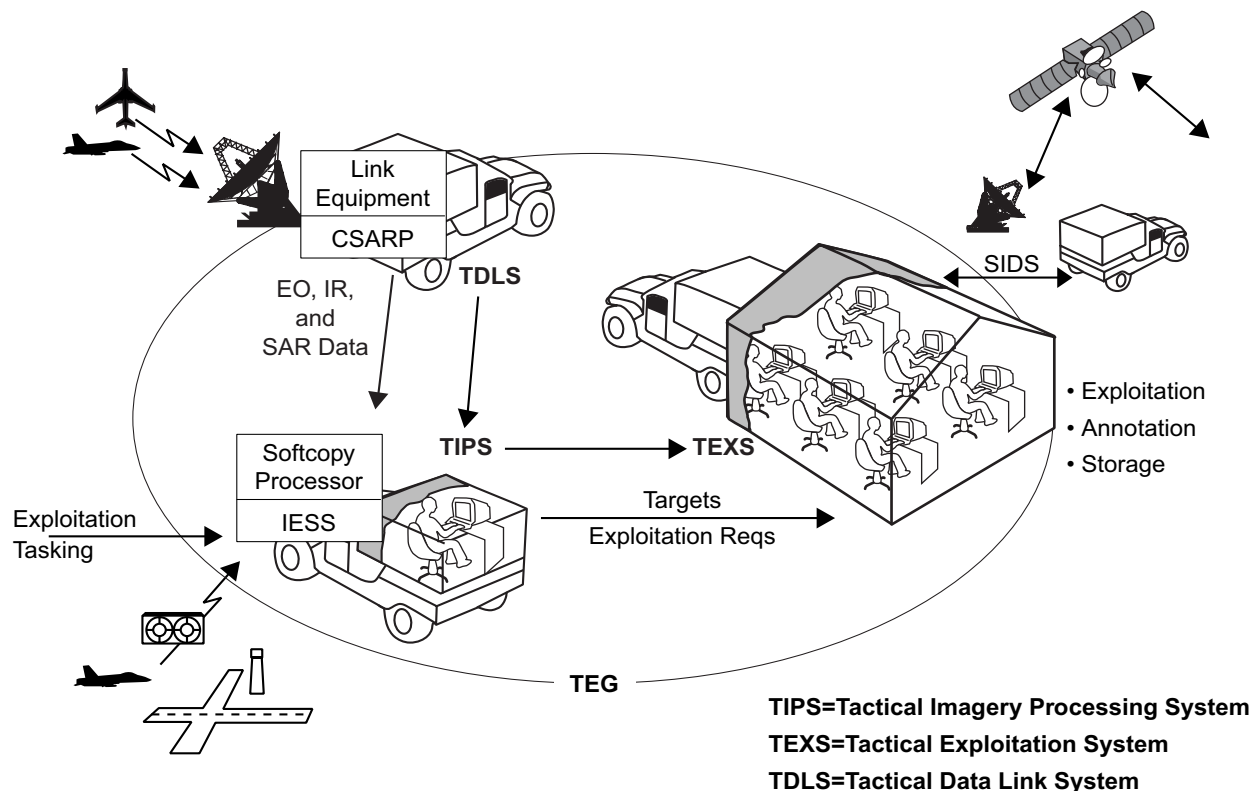

Figure 3-2. Tactical Exploitation Group Concept of Employment.

Joint Worldwide Intelligence Communications System (JWICS), pertinent MEF local area networks (LANs), and designated wide area networks (WANs). There are, however, no communications personnel organic to the IIP or to the intel bn. Communications requirements beyond these must be provided by communications battalion or the supported unit.

The IIP will require at a minimum a dedicated 512 kilobytes per second communications connectivity via SIPRNET to pull imagery from national, theater, and other sources and to disseminate finished IMINT products throughout the MEF and to others as required. This communication requirement is based upon providing a sustained new imagery production rate of 75 images per day for the IIP which is equivalent to their maximum exploitation capability (based upon the current numbers of imagery interpreters and equipment in the IIP's table of organization [T/O]

and table of equipment [T/E]) and the baseline projected requirement for the MEF CE and all MSCs to pull from the imagery archive.

Maintenance

The IIP is capable of 1st through 4th echelon maintenance of organic imagery equipment through Marines and civilian contract technicians organic to the platoon. All other maintenance support must be provided by the MEF headquarters group (MHG), combat service support element (CSSE) or supported unit.

Transportation

Intel bn has limited organic vehicular transportation assets to support IIP operations. External transportation support from the MHG, the CSSE, or the supported unit is necessary to displace the entire IIP simultaneously.

Joint Surveillance Target Attack Radar System Common Ground Station

Mission

The primary mission of the JSTARS CGS is to provide the MEF with near-real-time (NRT) access to the moving target indicator (MTI), fixed target indicator (FTI), and SAR data from the Air Force JSTARS collection platform, the E-8C.

Tasks

- Receive, process, manipulate, store, and display MTI, FTI, and SAR data from the JSTARS sensors simultaneously.
- Disseminate JSTARS data to the MEF G-2, other elements of the MEF, and other forces as directed.
- Assist with the planning and direction of JSTARS operations in support of the MEF.
- Provide the capability to communicate, via voice or digital link, with the JSTARS aircraft.

Organization

I, II, and III MEF have one JSTARS CGS and one JSTARS work station that will be used to source all MAGTF JSTARS requirements.

Command and Control

Intel bn commander maintains full command of JSTARS CGS activities.

MEF CE Staff Cognizance

The MEF commander will usually exercise C2 over the intel bn elements, to include the JSTARS CGS, via the MAGTF intelligence officer. The intel bn commander, as the ISC, performs this function under the staff cognizance of the AC/S G-2. This allows for the centralized direction and effective integration of JSTARS operations with other MAGTF IMINT operations and the broader all-source intelligence concept of operations.

Support Relationships

The JSTARS CGS will operate in general support of the MEF.

Concept of Employment

E-8C

Although the JSTARS aircraft is operated and maintained by the Air Force, it is considered a national asset. Its primary mission is the dedicated support of a JTF's joint force land component commander or ground component commander under the overall direction of the joint force commander (JFC).

Properly employed, JSTARS is capable of performing intelligence support, attack support, and battle management functions, along with support to special missions. Its sensor suite provides detection and tracking of moving targets through use of MTI, FTI, and SAR radars. Radar data collected by the E-8C is distributed via an onboard LAN to an encrypted, highly jam-resistant surveillance and control data link (SCDL) for real-time transmission to an unlimited number of CGS.

CGS

The CGS generally will be located within the IOC, near the P&A cell. Once the JSTARS information is received from the E-8C at the CGS, the entire MTI/FTI/SAR image will be disseminated throughout the MEF in accordance with intelligence reporting criteria stipulated by the MAGTF intelligence officer. Under routine conditions this data will be disseminated to the P&A cell for follow-on analysis and fusion with other intelligence data into all-source intelligence products.

Additionally, METT-T factors may require that E-8C data be provided to other elements of the MEF. Under such situations, this data is disseminated to subordinate units via the MEF TDN. The MTI/FTI/SAR image, with its associated data, will be viewed by recipients using common USMC hardware and software suites (potentially down to and including the regimental/group level).

Miscellaneous

Communications and Information Systems

The JSTARS CGS has sufficient communications resources to support internal C2, operations, and intelligence requirements as well as external CIS with the E-8C aircraft. Typically, the JSTARS CGS will require access to the SIPRNET, Nonsecure Internet Protocol Router Network (NIPRNET), possibly JWICS, and pertinent LANs and WANs. CGS team members operate all organic CIS equipment. CIS requirements beyond these must be provided by the MEF communications battalion.

Maintenance

The JSTARS CGS team is capable of 1st through 4th echelon maintenance of organic imagery equipment. All other maintenance support must be provided by the MHG or CSSE.

Transportation

The JSTARS CGS team has sufficient resources to displace all CGS equipment. Additional support will be necessary from the MHG or CSSE to displace CGS personnel simultaneously.

Selected Items of Equipment

CGS. The JSTARS CGS consists of two heavy HMMWVs with integrated shelters and an organic mobile electric power generator. The mission vehicle contains two workstations and associated communications equipment that enable the CGS operators to download, manipulate, and disseminate MTI, FTI, and SAR data received from the JSTARS aircraft. The support vehicle provides transportation for the crew and contains the SCDL antenna that links the CGS to the aircraft.

E-8C. The E-8C is a 707-300 series aircraft that has been extensively remanufactured and modified to achieve like-new performance and a greatly extended service life (see figure 3-3). The most prominent external feature of the modified aircraft is the 26-foot long, canoe-shaped radome located under the forward fuselage. An in-flight



Figure 3-3. E-8C JSTARS Aircraft.

refueling system extends the E-8C's 11-hour mission endurance, making missions of 20 hours or more possible. The E-8C's 140-foot long cabin readily accommodates the operator workstations, communications suite and associated equipment, with space for rest areas and other crew facilities (see figure 3-4). The standard mission crew complement is 21, but an augmented mission crew of 34 can be easily accommodated.



Figure 3-4. E-8C JSTARS Air Force and Army Crew Onboard Positions.

Direct Support Teams, Production and Analysis Company, Intelligence Battalion

Mission

The mission of DST is to provide enhanced intelligence planning and direction, analytical, production,

and dissemination capabilities to designated supported-unit(s) intelligence sections.

Tasks

- Provide connectivity to the P&A cell for the receipt and dissemination of intelligence to the supported unit.
- Assist the supported unit's intelligence officer in the formulation and management of external intelligence support requirements and other intelligence planning and direction activities.
- Tailor P&A cell and other external-source intelligence products to the needs of the supported unit.
- Perform IPB in support of future operations planning.
- Prepare intelligence products to support detailed mission planning and execution by MEF MSCs or other supported units.
- Augment and enhance the dissemination efforts of the supported unit's intelligence section.
- Act as liaison between the supported unit and the P&A cell.

Organization

There are two DSTs within the P&A company, intel bn. Each team is led by a gunnery sergeant, MOS 0231. Each team also has one imagery analyst (a staff sergeant) to assist with imagery planning and IMINT activities. Other team members include one terrain analyst, two intelligence specialists, and one intelligence clerk. The DST, however, does not have any specialized IMINT equipment.

Command and Control

The DSTs are subordinate units of intel bn, with the intel bn commander maintaining full

command of its activities. Under their principal concept of employment, DSTs are under the OPCON of the supported unit commander. The supported commander will exercise OPCON via the unit's intelligence officer. Intelligence taskings to the DSTs will be via the DST team leader in accordance with the supported unit's concept of intelligence operations.

Concept of Employment

The DSTs are primarily employed as organic teams either attached to or placed in direct support of a designated subordinate commander (e.g., the MEF main effort, a MEU/MEB, a special purpose MAGTF). When not employed, DSTs generally augment the P&A cell.

Miscellaneous

Communications and Information Systems

The DSTs have sufficient CIS resources to support internal and detachment C2 and intelligence requirements. They typically will require access to the SIPRNET, NIPRNET, possibly JWICS, and pertinent LANs and WANs. There are no communications personnel organic to the DST. CIS requirements beyond these must be provided by the supported unit.

Maintenance

The DST is capable of 1st echelon maintenance of organic equipment. All higher maintenance is provided by the MHG, CSSE or the supported unit.

Transportation

Intel bn has limited organic vehicular transportation assets to support battalion and DST operations. External transportation support from the MHG, CSSE or the supported unit generally will be necessary to displace the full DST.

Marine Unmanned Aerial Vehicle Squadron

Mission

The VMU operates and maintains a UAV system to provide unmanned aerial reconnaissance support to the MEF or other supported units.

Tasks

- Conduct aerial reconnaissance (to include imagery collection and reporting), surveillance, and target acquisition. This includes performing airborne surveillance of designated target areas, MEF or other areas of interest, and other areas as directed; airborne surveillance for search and rescue and tactical recovery of aircraft and personnel; and reconnaissance of helicopter approach and retirement lanes in supporting vertical assaults.
- Provide real-time target information to the direct air support center and fire support coordination center(s) to facilitate adjusting fire missions and close air support.
- Provide real-time intelligence reporting to the SARC to support MEF IRs and facilitate all-source intelligence operations.
- Provide information to assist adjusting indirect-fire weapons and to support and facilitate direct air support and air interdiction.
- Collect information to support BDA and combat assessment.
- Support rear area security.
- Provide VMU remote receive station (RRS) capability and liaison to designated units.

Organization

The VMU is organic to the Marine aircraft wing (MAW) and is structured to operate as a subordinate

unit of one of the Marine air control groups (MACGs). There are two VMUs within the Marine Corps: VMU-1 (MACG-38, 29 Palms, CA) and VMU-2 (MACG-28, Cherry Point, NC). The VMU is organized into various sections that give it the capability to operate and maintain one UAV system and associated support equipment. Regarding IM-INT operations, VMU has one Pioneer short-range (SR) system with five UAVs. Key squadron sections include: the S-2 section, including collections, all-source intelligence and five imagery analysts; UAV systems mission commanders and the external and internal UAV operators within the S-3 section; and the Marine aviation logistics squadron augment section that provides intermediate-level aviation maintenance and supply support.

Command and Control

General

VMU is under the command of the MAW CG or, when deployed in support of MAGTFs smaller than a MEF, the ACE commander. The commander exercises C2 via the ACE G-3/S-3 and the Marine air command and control system (see MCWP 3-25, *Control of Aircraft and Missiles*). Air operations (flight taskings, airspace deconfliction, etc.) are planned, coordinated, and controlled by the ACE G-3/S-3 via the tactical air command center (TACC). Intelligence missions, however, are in accordance with the intelligence and reconnaissance mission requirements designated by the MEF or supported unit commander, requiring close coordination between the intel bn's IOC and the MAW's TACC. To assist with UAV mission planning and execution, VMU will generally provide a task-organized team to the IOC, which will typically operate from within the SARC.

Support Relationships

General Support. VMU typically operates in general support of the MEF. Under general support, the MEF commander, through the G-2, determines VMU intelligence priorities and information and intelligence dissemination flow. The AC/S G-2 will exercise staff cognizance of VMU intelligence operations via the ISC.

Direct Support. Depending upon METT-T considerations, specified VMU missions may be in direct support of a particular MEF unit or MSC (e.g., to the Marine division or its main effort). In such cases the scope of the supported commander's C2 authority over VMU missions will usually be specified to ensure effective support to the operations while allowing the MAGTF commander to maintain effective C2 of broader intelligence and IMINT operations. Direct support may entail dedicated C2, planning, and exploitation support to the supported unit via a VMU detachment with a RRS capability.

Concept of Employment

Operational

VMU can support any size MAGTF. Normal employment would be as an integral unit of the MAGTF's ACE in support of MAGTF operations. The squadron is also capable of limited independent operations.

Intelligence

The VMU may conduct limited imagery exploitation or analysis. Generally, UAV imagery is screened by VMU imagery analysts for information of immediate tactical value in accordance with the intelligence collection and reporting criteria stipulated by the ISC or the supported unit's intelligence officer. Imagery tapes are subsequently delivered by VMU to the IIP for further detailed imagery analysis and IMINT and all-source intelligence production. The MAGTF intelligence officer is responsible for subsequent

IMINT dissemination (to include secondary imagery dissemination).

Miscellaneous

Communications and Information Systems

Together with CIS resources supporting the Marine air command and control system (MACCS), VMU has sufficient CIS resources to support internal and squadron C2, operations, and intelligence requirements. VMU typically requires access to various networks to conduct its operations, to include SIPRNET and NIPRNET, and to pertinent LANs and WANs.

Maintenance

VMU is capable of conducting 1st and 2d echelon maintenance on assigned ground equipment, including motor transport, engineering, and communications equipment. The force service support group (FSSG) or supporting CSS detachment performs 3d and 4th echelon maintenance on ground equipment. The squadron is also capable of performing organizational maintenance on its aviation equipment. The Marine aviation logistics squadron performs limited, specialized intermediate-level maintenance on squadron aviation equipment.

Equipment

See appendix D for detailed information on VMU equipment and performance characteristics.

Marine All-Weather Fighter Attack Squadron

Mission

The mission of the VMFA(AW) is to attack and destroy surface targets, day or night, under adverse weather conditions; conduct multisensor imagery reconnaissance; provide supporting arms

coordination; and intercept and destroy enemy aircraft under all weather conditions.

Tasks

- Conduct day and night close air support, under all weather conditions.
- Conduct day and night deep air support, under adverse weather conditions, including armed reconnaissance, radar search and attack, air interdiction, and strikes against enemy installations, by using all types of weapons that are compatible with assigned aircraft.
- Conduct multisensor imagery reconnaissance, including prestrike and poststrike target damage assessment and visual reconnaissance.
- Conduct day and night supporting arms coordination, including forward air control, tactical air coordination, and artillery/naval gunfire spotting.
- Intercept and destroy enemy aircraft in conjunction with ground and airborne fighter direction.
- Conduct battlespace illumination and target illumination.
- Conduct armed escort of friendly aircraft.
- Maintain the capability to conduct suppression of enemy air defense operations.

Organization

There are six F/A-18D VMFA(AW)s in the operating forces. Each squadron has 12 reconnaissance-capable aircraft. However, only four can be configured with ATARS at any one time to provide this aerial reconnaissance capability. The VMFA(AW) will normally function as an integral unit. It is structured to operate as a subordinate unit of a MAG.

Command and Control

General

The VMFA(AW)s are under the command of their parent group commander. Overall, OPCON rests with the MAW or ACE commander. The

commander exercises C2 via the ACE G-3/S-3 and the MACCS (see MCWP 3-25). Air operations (flight taskings, airspace deconfliction, etc.) are planned, coordinated, and controlled by the ACE G-3/S-3 via the TACC. Intelligence missions, however, are in accordance with the mission requirements designated by the MEF or supported unit commander, requiring close coordination between the intel bn's IOC, the TACC, and supported commanders.

Support Relationships

General Support. VMFA(AW)s typically operates in general support of the MAGTF in accordance with missions contained in the air tasking order (ATO).

Direct Support. Depending upon METT-T considerations, specified VMFA(AW) missions may be in direct support of a particular unit or the ACE or CSSE of the MAGTF. The ATO will identify such missions and pertinent C2 and intelligence operations direction.

Concept of Employment

Operational

The VMFA(AW) will normally be employed as an integral unit of an ACE in support of MAGTF operations.

Intelligence

When equipped with ATARS and tasked to conduct imagery collection missions, the squadron coordinates operations closely with the IOC, the MAW's G-2, the IIP, and others as appropriate. Prior to the fielding of the common data link (CDL), exploitation and processing of ATARS imagery will take place once the aircraft has returned to base and the imagery data tapes are physically downloaded and delivered to the IIP.

Once the CDL is fielded, VMFA(AW) will be capable of NRT downlinking of selected images; the remaining imagery data will be recorded on

tape and downloaded postmission for follow-on delivery to the IIP for imagery exploitation. Figure 3-5 provides an overview of VMFA(AW) ATARS operations.

Miscellaneous

Administrative

The VMFA(AW) is capable of self-administration.

Communications and Information Systems

Together with CIS resources supporting the MACCS, VMFA(AW) has sufficient CIS resources to support internal and squadron C2, operations, and intelligence requirements. VMFA(AW) typically will require access to various networks to conduct its operations, to include SIPRNET, NIPRNET, and pertinent LANs and WANs.

Maintenance

The squadron is capable of conducting 1st echelon maintenance on all assigned equipment. It is also

capable of performing organizational maintenance on assigned aircraft and support equipment. Maintenance beyond these capabilities is provided by other ACE and CSSE elements.

Marine Light/Attack Helicopter Squadron

Mission

The HML/A provides combat utility helicopter support, attack helicopter fire support, and fire support coordination during expeditionary operations.

Tasks

- Provide fire support and security for forward and rear area forces.
- Conduct point target/antiarmor operations.
- Conduct antihelicopter operations.
- Provide armed escort, control, and coordination for assault support operations.

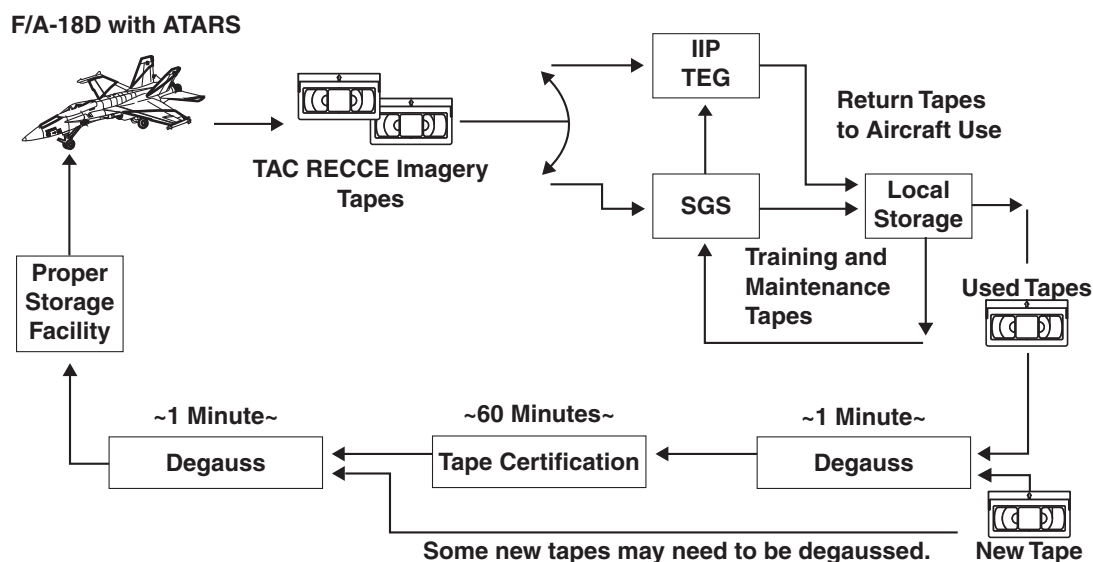

Figure 3-5. F/A-18 ATARS Tactical Reconnaissance Imagery Tape Processing Flow.

- Control, coordinate, and provide terminal ordnance for supporting arms, including close air support, artillery, mortars, and naval gunfire.
- Provide point and limited-area air defense from threat fixed-wing aircraft.
- Conduct armed imagery and visual reconnaissance.
- Augment local search and rescue assets.
- Maintain the capability to operate from amphibious shipping, other floating bases, and austere shore bases as required.
- Maintain the capability to operate at night, in adverse weather conditions, and under instrument flight conditions at extended ranges.
- Perform organizational maintenance on assigned aircraft in all environmental conditions.

Organization

There are six HML/As in the operating forces. Each squadron has 18 AH-1W Super Cobras and 9 UH-1N Huey aircraft, all are reconnaissance capable. An HML/A will normally function as an integral unit, and is structured to operate as a subordinate unit of a MAG.

Command and Control

General

The HML/As may remain under the command of their parent group commander. An HML/A may be attached to a MAGTF where they would operate under the direction of an ACE commander. The commander exercises C2 via the ACE G-3/S-3 and the MACCS (see MCWP 3-25). Air operations (flight taskings, airspace deconfliction, etc.) are planned, coordinated, and controlled by the ACE G-3/S-3 via the TACC. Intelligence missions, however, are in accordance with the intelligence and reconnaissance mission requirements designated by the MEF or supported MAGTF/unit commander and exercised via the staff cognizance of the MAGTF G-2/S-2, requiring close coordination

between IOC, the TACC, the squadron, and the supported commanders.

Support Relationships

General Support. HML/As typically operate in general support of the MAGTF in accordance with missions contained in the ATO.

Direct Support. Depending upon METT-T considerations, specified HML/A missions may be in direct support of a particular unit or major subordinate elements of the MAGTF. The ATO will identify such missions and pertinent C2 direction.

Concept of Employment

Operational

HML/A will function either as an integral unit or as a squadron (-) with separate aircraft composite detachments. Each HML/A can support the simultaneous deployment of three detachments consisting of six AH-1W and three UH-1N aircraft per detachment. This concept of organization facilitates dual-site operations, provides for the support of simultaneous contingencies, and allows for the fulfillment of continuous unit deployment program requirements.

Intelligence AH-1W Night Targeting System

The night targeting system (NTS) is an airborne EO system designed to provide the AH-1W crew with the capability to detect, recognize, identify, track, laser range and laser designate targets during day, night, and adverse weather conditions. The NTS is comprised of the following subsystems: FLIR, charged coupled device (CCD) low light level television; direct view optics; AN/ASQ-211 laser designator/rangefinder system and television tracker (TVT); and a super video cassette recorder. The TVT (commonly called the autotracker) and videocassette recorder operate in conjunction with the CCD-TV and FLIR only.

With incorporation of the NTS, the AH-1W Super Cobra provides enhanced air reconnaissance capabilities to include day/night optical and FLIR imagery collection, precision automatic target tracking, laser designation, and video recording. Although the principal purpose of the NTS is to provide Super Cobra gunners the ability to use TOW and Hellfire II missiles and other weapons at full range both at night and through most battlefield obscuration, it is used to collect imagery of a variety of targets during armed reconnaissance missions for follow-on intelligence processing, production, and use.

UH-1N Night Thermal Imaging System

The night thermal imaging system (NTIS) is an airborne EO system designed to provide the UH-1N crew with the capability to detect, recognize, identify, and laser range targets during day, night, and adverse weather conditions, as well as provide a basic pilotage function. The NTIS is comprised of the following subsystems: FLIR, laser rangefinder system, and a videocassette recorder.

Imagery Mission Employment

When AH-1W or UH-1N aircraft is tasked to conduct imagery collection missions, the squadron coordinates operations closely with the MEF's IOC, the ACE G-2/S-2, the IIP and others as appropriate.

Follow-on intelligence processing and exploitation of NTS and NTIS imagery will take place once the aircraft has returned to base and the imagery videotapes are physically downloaded and delivered to the IIP. (Figures 3-6 and 3-7 identify the NTS and NTIS equipment on the AH-1W and UH-1N.)

Miscellaneous

Administrative

The HML/A is capable of self-administration.

Communications and Information Systems

Together with CIS resources supporting the ACE's MACCS, HML/As have sufficient CIS



Figure 3-6. AH-1W with the NTS.



Figure 3-7. UH-1N with the NTIS.

resources to support internal and squadron C2, operations, and intelligence requirements. It typically requires access to various networks to conduct its operations, to include SIPRNET, NIPRNET, and pertinent LANs and WANs.

Maintenance

The squadron is capable of conducting 1st echelon maintenance on all assigned equipment, and capable of performing organizational maintenance on assigned aircraft and support equipment. Maintenance beyond these capabilities is provided by other elements of the ACE and CSSE.

Ground Reconnaissance Units

Mission

The force reconnaissance company and division reconnaissance battalions provide amphibious, deep ground, and ground reconnaissance; surveillance; battlespace shaping; and limited scale raids in support of the Marine division, its subordinate elements, and the MEF, other MAGTFs or a joint force. IMINT capability fielded to these units is the man packable secondary imagery dissemination system (Manpack SIDS).

Command and Control

Force reconnaissance company and the division reconnaissance battalion are under the command of the supported unit's commanders.

MAGTF CE Staff Cognizance

For intelligence and reconnaissance missions the commander will exercise C2 over ground reconnaissance via the unit's intelligence officer. At the MEF level, the AC/S G-2 will exercise this staff cognizance via the ISC. This allows for the centralized direction and effective integration of ground reconnaissance operations with the broader all-source intelligence concept of operations.

Support Relationships

General Support. Ground reconnaissance units normally operate in general support of the unit.

Direct Support and Attached. Depending upon METT-T considerations, ground reconnaissance units may be employed in direct support of or attached to a particular subordinate unit (e.g., force reconnaissance teams attached to advance force elements for an expeditionary operation; division reconnaissance battalion's platoons or teams

attached to or in direct support of the division's main effort). The scope of the supported commander's C2 authority over designated ground reconnaissance teams will usually be specified to ensure effective support to the operations while allowing the MEF or division commander to maintain effective C2 of broader intelligence and reconnaissance operations.

Manpack SIDS Concept of Employment

Manpack SIDS is a self-contained system comprised of three outstations, a base station, digital cameras, and other specialized devices; communications support must come from other resources. It enables ground reconnaissance units to take pictures of designated targets and then send the images back to the base station over selected communications paths (e.g., high and very high frequency [HF and VHF] single-channel radios and ultra high frequency satellite radios).

The base station then feeds the images into the MAGTF TDN for follow-on dissemination to other MAGTF or other units (figure 3-8 depicts one possible communications architecture for Manpack SIDS). This provides the means to process the images or photocopy sketches even before the team is extracted.

The outstation, with its digital camera component, will be employed by ground reconnaissance teams during missions for imagery acquisition. Imagery collected by the outstation may be stored for subsequent delivery to and analysis by the IIP, or may be electronically transmitted to the base station over organic tactical communications assets for near-real time analysis by the IIP. The base station generally will be employed at the reconnaissance operations center (ROC) collocated with the

supported unit's main command echelon for receipt, manipulation, annotation, and subsequent retransmission of imagery collected by the outstation teams.

Depending upon the tasked IRs and the situation, the base station will then disseminate acquired imagery and related information to the P&A cell within the IOC (force reconnaissance team operations), to the division's combat intelligence center for follow-on intelligence analysis, production, and dissemination (division reconnaissance battalion operations) or directly to pertinent unit(s) C2 centers.

Dissemination will generally be in accordance with the intelligence reporting criteria stipulated by the ISC (for force reconnaissance company operations) or the division's intelligence operations officer or supported unit's intelligence officer (for reconnaissance battalion operations) via the MAGTF TDN to the recipient's IAS.

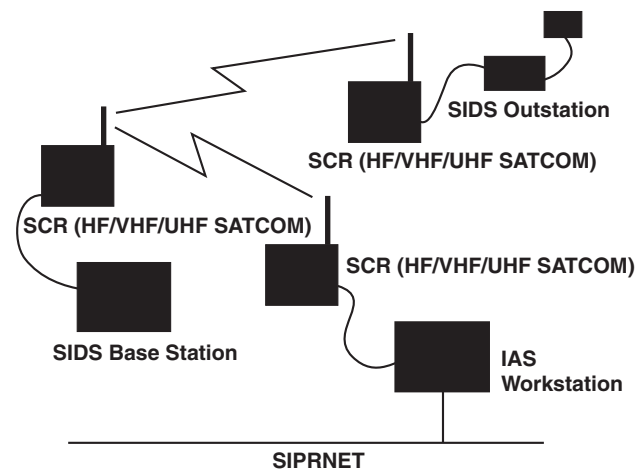

Figure 3-8. Manpack SIDS Communications Connectivity.

Tactical Intelligence Photographic Capability

TACPHOTO is a program related to Manpack SIDS. TACPHOTO provides an organic digital camera collection and processing capability—but without the palmtop processor and base station organic to Manpack SIDS—to a wide range of MAGTF units (see figure 3-9). TACPHOTO allows ground patrols, flight crews and others to collect images per their unit’s IRs or external taskings. Upon mission completion and return to base, the acquired images will be downloaded into supporting processing resources for follow-on intelligence production and use. Digitized images can also be further disseminated throughout the MAGTF via the TDN.

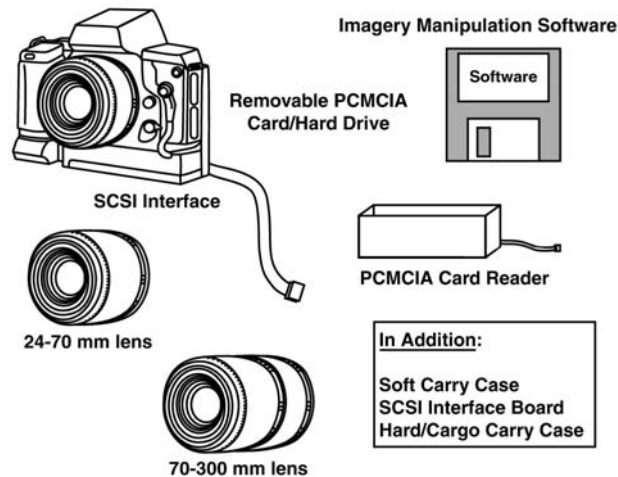

Figure 3-9. Tactical Intelligence Photographic Capability.

CHAPTER 4. IMAGERY INTELLIGENCE SYSTEMS, C2 NODES, COMMUNICATIONS INFORMATION SYSTEMS, AND OTHER SYSTEMS

Communications dominate war; broadly considered, they are the most important single element in strategy, political or military.

—Alfred Thayer Mahan

MAGTFs require significant C2 and CIS support to execute IMINT operations. Imagery systems technological developments have the potential to provide the commander with outstanding imagery support. However, the technical (particularly message and data traffic volumes versus available communications channels bandwidth) and operational needs (i.e., routine versus time-sensitive tailored IMINT support) require detailed planning and coordination of CIS support to conduct effective IMINT operations.

The Marine Corps receives and disseminates imagery as part of the Global Command and Control System (GCCS), via the Defense Information Systems Network (DISN), using Ground Mobile Forces (GMF), digital backbone, tactical radios, and Trojan Spirit II (TS-II). This chapter describes the MAGTF's major current and future IMINT C2 and CIS nodes.

Key to providing the MAGTF commander with IMINT support is understanding the size of imagery data and the capacities of communications pipelines required to transmit this data throughout the MAGTF and to pertinent external organizations. As a general rule, a high capacity (at least T-12) communications pipeline is required for incoming imagery data to the MAGTF, with lesser but still significant capacities required at times for internal MAGTF imagery data dissemination. While most MAGTF requirements can be satisfied via GENSER communications channels (e.g., SIPRNET), the MAGTF must also

have SCI communications support (e.g., JWICS) to satisfy some critical requirements.

Basic Imagery Intelligence Communications and Information Systems Requirements

The standard IMINT CIS requirements for a MAGTF operation are—

- **The capability to C2 subordinate units.** Intelligence officers and IMINT element commanders/OICs must be capable of positive C2 of subordinate units and integration of their operations with broader MAGTF and external intelligence and operations C2. Traditionally single-channel radio and record message traffic have been used to support C2 of MAGTF IMINT units. In semistatic situations, secure e-mail or telephone may be the method of choice, while in highly fluid or mobile scenarios, cellular, SATCOM, and VHF and HF radio may be used.
- **The ability to receive collected data and information from the full range of organic and external IMINT organizations.** The CIS architecture must provide connectivity between organic and supporting IMINT elements (such as the VMU, Manpack SIDS capable ground reconnaissance teams), IMINT production and analysis centers (e.g., JTF's NIST, IIP and MCIA), and supported MAGTF operations and intelligence centers. Requirements include the capability to transmit image data files and IMINT reports digitally via fiber-optics, wire, or radio in formats (both voice and data) that are readily usable by imagery and all-source intelligence analysts.

- **The ability to provide intelligence to supported commanders.** IMINT CIS requirements will be influenced by supported commanders' intents, concepts of operations and intelligence, command relationships, and standing PIR and IRs. The CIS architecture must be capable of integrating IMINT element C2 and supporting CIS operations (to include both GENSER and SCI communications) with the primary CIS channels used by supported commanders.
- **The ability to share IMINT products and reports with MAGTF P&A Cell and with IMINT and all-source JTF, other components, theater, and national IMINT and intelligence centers.** The traditional means for providing this capability are MAGTF GENSER secure record and voice communications. While these techniques continue to be used, they are rapidly becoming secondary in importance to the use of JWICS, SIPRNET, and other CIS capabilities that allow participants to access each others' imagery and IMINT products and databases and to immediately pull required data, intelligence, and other IMINT products.

Imagery Intelligence and Key Related Command and Control Nodes

A wide variety of IMINT operations and supporting C2 and CIS may support military operations.

Organization

NIMA

The Director, NIMA, coordinates national CIS support to military and intelligence agencies. NIMA established CIS interoperability standards and data formats for all IMINT operations. Military forces and intelligence agencies use these standards and data formats to support interoperable planning and direction, collection, production, and dissemination of IMINT.

A NIMA Customer Support Response Team (CSRT) may be integrated into a NIST or may be deployed in direct support of a military force. The CSRT will typically contain a deployable imagery/geospatial server known as the Quick Response System (QRS). The QRS is self-contained and generally requires only satellite communications (SATCOM) channel access support from the JTF or other supported unit. The JTF J-2 coordinates SATCOM channel and communications security (COMSEC) support through the JTF J-6. Additionally, depending upon the situation, other CIS and related support that a NIST may require from the supported unit includes information systems technical support and an access controlled secure area (generally within the supported unit's tactical sensitive compartmented information facility [TSCIF]).

During operations, the CSRT QRS provides a MAGTF with a wide range of imagery and geospatial information and services support. In support of garrison operations, a NIMA CSRT provides special training and exercise support to MAGTFs. Also, NIMA may provide MAGTFs temporary specialized equipment to meet unique operational needs or to satisfy critical deficiencies.

National Reconnaissance Office

The NRO has theater-focused customer support teams to provide direct operational support to MAGTFs and other forces. These teams include on-site military/contractor personnel collocated with the combatant and other commands. Basic support includes education on NRO systems and capabilities; training on tasking; and receiving, processing, and analyzing data collected by NRO systems. Equipment and personnel are available to support MAGTF operations during contingencies. NRO support elements are usually self-sufficient, requiring no MAGTF CIS operational support beyond routine communications coordination.

National Intelligence Support Team

All-source national intelligence level IMINT and other intelligence assets may deploy in support

of JTF (and even directly in support of MAGTF) operations as well as providing critical support via reach back and collaborative capabilities. The NIST is the most typical method used. The NIST is a task-organized unit generally consisting of DIA, NSA, CIA, and, as appropriate, NIMA personnel and equipment. Its mission is to provide a tailored, national level all-source intelligence team to deployed commanders (generally at the JTF headquarters level, but support could be provided to other commands) during crisis or contingency operations. Depending upon the supported unit's requirements, a NIST can be task-organized to provide coordination with national intelligence agencies, analytical expertise, I&W, special assessments, targeting support, streamlined and rapid access to national intelligence databases and other products, and assistance facilitating request for intelligence (RFI) management (see figure 4-1).

DIA, through the joint staff J-2, controls the NIST for deployment and administrative purposes (see figure 4-2 on page 4-4 for an overview of a NIST's deployment cycle). During operations a NIST will usually be in direct support of the JFC, who exercises C2 of it via the JTF J-2. Once deployed, the

intelligence agencies with representatives on the NIST provide leadership. The basic C2 relationships between the NIST and the JTF (or other supported commands) command relationship are direct support. The NIST will be under the staff cognizance of the JTF J-2, performing intelligence support functions as so designated. The basic NIST concept of operations is to take the J-2's RFIs and collection and production requirements, discuss and deconflict these internally within the NIST to determine which element(s) should take these for action. Each NIST element leader, and as coordinated by the NIST team chief, will conduct liaison with their parent national intelligence organization. Intelligence generated by the NIST is available to the JTF J-2 JISE, the JFC, and other elements of the JTF with the usual restriction based on clearance and programs.

The composition and capabilities of each NIST deployment is unique based on the mission, duration, agencies representation, and capabilities required (see figure 4-3 on page 4-4). A NIST, however, is not a totally self-contained element. It requires logistic and other support from the supported command. Depending upon the situation, support that a NIST requires from the supported

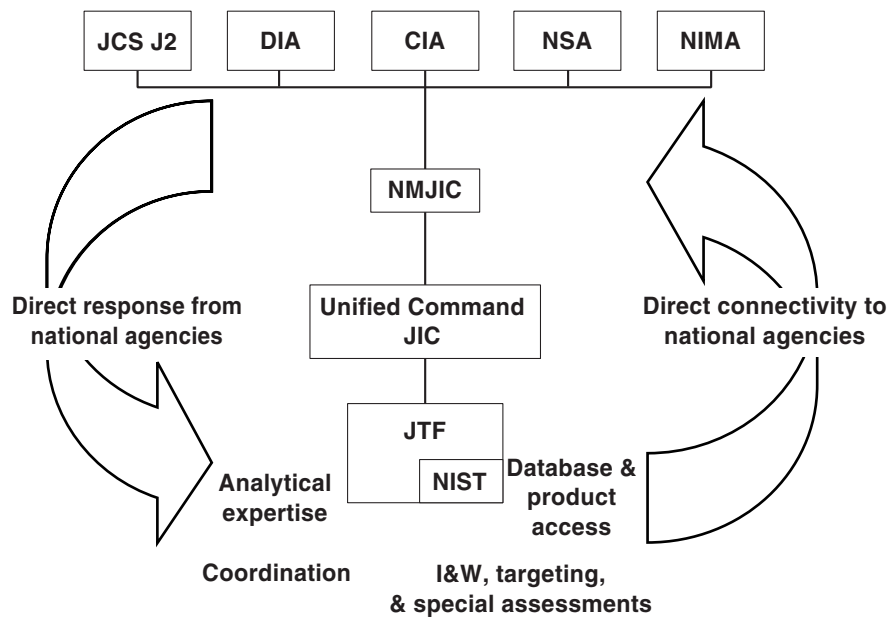

Figure 4-1. NIST Capabilities.

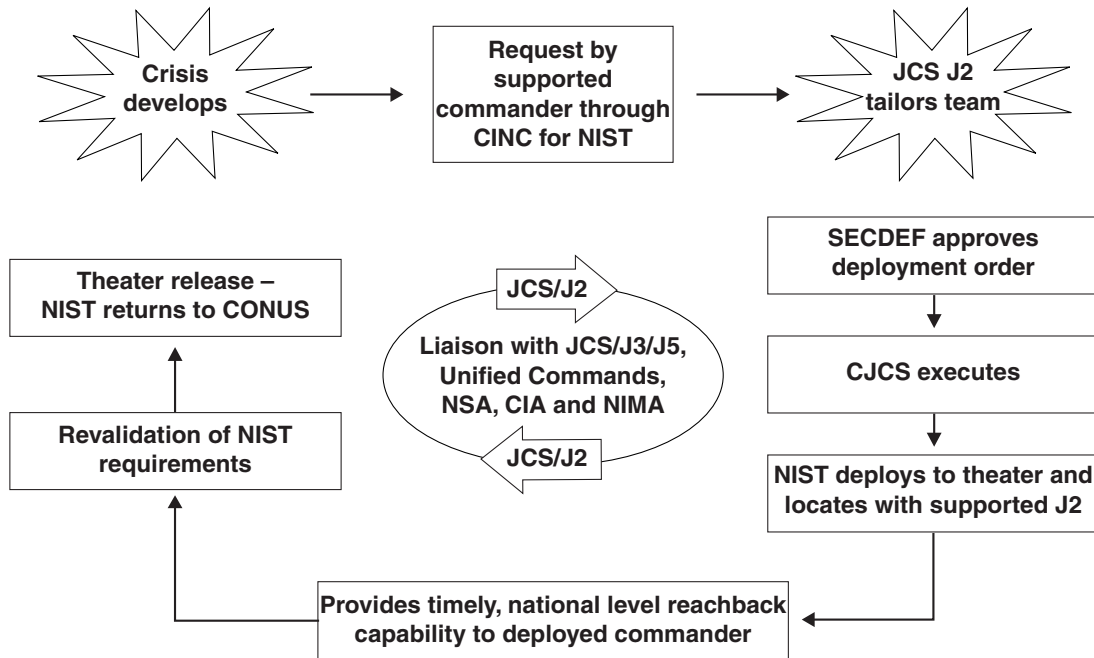

Figure 4-2. NIST Deployment Cycle.

CIA	DIA	A NIST is task-organized to fulfill the supported commander's intelligence requirements
Four personnel (two analysts, two communicators)	Four personnel (three analysts, one systems technician)	
Associated comms and info systems workstations	Associated comms and info systems workstations	
NSA	NIMA	
Five to twelve personnel (analysts, systems technicians, and communicators)	Two personnel (one imagery analyst, one geospatial analyst)	
Associated comms and info systems workstations	Associated info systems workstations	

Figure 4-3. Notional Composition of a NIST.

unit includes information systems technical support and an access controlled secure area (generally within the supported unit's TSCIF).

A NIST's organic capabilities generally encompass only intelligence and some unique CIS support. NIST CIS capabilities will be task-organized. A

NIST may range from a single agency element's voice connectivity to a fully equipped NIST with JISE and JWICS video teleconferencing (VTC) capabilities (see figure 4-4 for one of a NIST's key sophisticated CIS capabilities). Current methods of operation continue to rely on both agency and supported command-provided communications paths to



Figure 4-4. NIST JWICS Mobile Integrated Communications System.

support deployed NIST elements. The systems that each element is capable of deploying are discussed in greater detail in JP 2-02, *National Intelligence Support to Joint Operations*, appendix C.

Theater

Combatant Commands' Joint Intelligence/Analysis Centers. The combatant commands' JICs and JAC are the cornerstones for fulfilling the IRs of the geographic combatant commanders and their subordinate commanders. The JICs and JAC are the primary sources from which subordinate JTFs receive intelligence support for their areas of interest, providing finished intelligence products supporting theater mission planning and execution.

Collection. The combatant commander's J-2 retains full collection management authority (i.e., to validate, modify or non-concur) over all intelligence collection requirements against targets within their area of responsibility. Such authority may be delegated to a subordinate JFC. Validated collection requirements, to include imagery collection,

that cannot be satisfied by organic JTF means will be submitted to the combatant command's JIC/JAC.

Processing and Exploitation. The JIC/JAC processes and exploits imagery in theater. Downlinked imagery data signals may be transmitted to workstations for either immediate exploitation, stored on tape, sent to digital archives for later use or laid out on film for exploitation.

Production. Combatant commands, services, and defense agency intelligence production centers' production responsibilities are clearly delineated within the DOD Intelligence Production Program (DODIPP). The DODIPP is structured to capitalize on the analytical and production resources of the entire DOD intelligence production community. It supports the efficient use of production resources, prevents duplication of effort, and enhances timely support to user IRs. The Community On-Line Intelligence System for End-Users and Managers (COLISEUM) automates DODIPP procedures for stating and tracking theater IRs and other intelligence production requirements. Results from imagery exploitation and the annotated images may

be incorporated into all-source intelligence products, stand-alone IMINT products or into various IMINT and intelligence databases.

Dissemination. The JDISS, which mainly uses JWICS for connectivity, is the primary intelligence system used by the JIC/JACs for both the receipt and dissemination of imagery and other intelligence products. Using these systems, multimedia intelligence dissemination (e.g., voice, data, imagery, record message, e-mail, graphics, and video) can be supported. Internally, the JIC/JACs use the Imagery Data Exploitation System (IDEX) for manipulation and exploitation of imagery, with JDISS and JWICS used for secondary imagery and other intelligence dissemination. File servers maintained by the JIC/JACs are key components of intelligence support. For imagery, the current capability is provided by the demand driven direct digital dissemination (5D) server, with NIMA's IPL planned as its replacement. These file servers can be accessed using JDISS providing subordinate commands and other users the ability to pull imagery and other intelligence when required. The JICs have access to all of the government-owned, common user networks used by the intelligence community: Automated Digital Network/Defense Message System, (AUTODIN/DMS), Defense Special Security Communications System (DSSCS), NIPRNET, SIPRNET, JWICS, and the Defense Switched Network (DSN). Access to military satellite systems includes the Defense Satellite Communications Systems (DSCS) and the Fleet Satellite Communications System. Commercial satellite access is also available through the International Maritime Satellite System and INTELSTAT.

JTF J-2 and the Joint Intelligence Support Element

The JTF J-2 organizational structure and capabilities will be situation and mission dependent as determined by the JFC and the JTF J-2. The JISE is the principal intelligence C2 node

within the JTF J-2. The JISE is the focus for JTF intelligence operations, providing the JFC and component commanders with situational awareness and other intelligence support regarding adversary air, space, ground and maritime capabilities and activities.

A NIST provided in support of the JTF headquarters will integrate its operations within the JISE. Key JISE functions and capabilities include collection management support, OOB analysis, identification of threat centers of gravity and critical vulnerabilities, and intelligence support to targeting and force protection.

All IMINT collection, production, and dissemination activities will be conducted within the JISE. Once IMINT products and support have been provided to the JTF and its components, updates will be accomplished by the JISE using push/pull dissemination techniques. Intelligence CIS based on the JDISS/JWICS functionality provide the JTF with the ability to query theater and national IMINT servers and databases for the most current intelligence.

Collection

The JTF J-2 collection manager will plan, coordinate, and use direct imagery collection operations in support of the JTF. As shown in figure 4-5, theater and JTF imagery collection assets include the U-2, JSTARS, theater UAVs, and other-Service assets such as the Navy's F-14/TARPS and the Air Force's RF-16. MAGTF interfaces with these collection assets are depicted by the lines in figure 4-5. Communication support planning provides connectivity from these major nodes into the TEG and MAGTF TDN.

Production

IMINT production requirements are managed by the JISE in accordance with the JFC's PIR and other validated IRs.

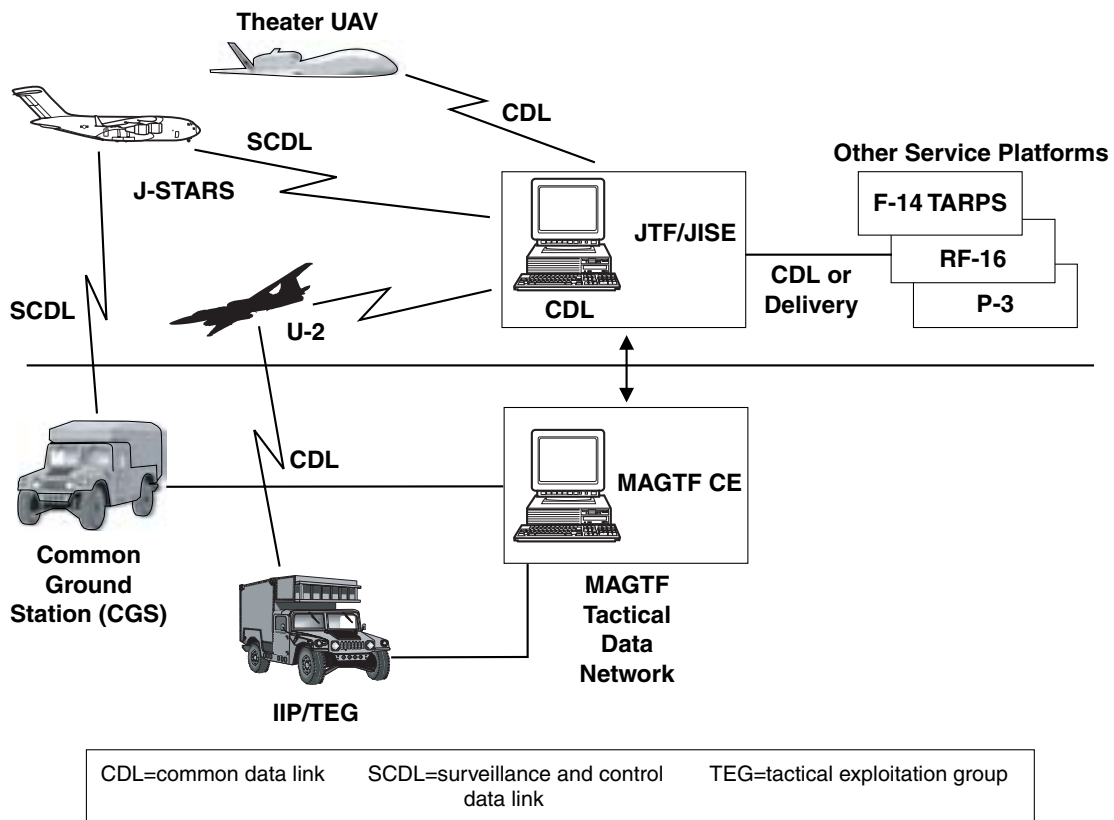

Figure 4-5. Theater/JTF Imagery Collection.

Dissemination

Once basic and current intelligence and imagery have been provided to a deploying JTF and its components, updates will be accomplished using push/pull dissemination techniques. Intelligence CIS based on the JDISS/JWICS functions provide the JTF with the ability to query theater and national IMINT servers and databases for the most current intelligence.

Amphibious Forces

LFs, when afloat, use the ATF’s imagery dissemination backbone, such as Challenge Athena and Joint Services Imagery Processing System (JSIPS)-Naval, and continue to receive imagery support from the Navy once ashore, via doctrinal communications.

Intelligence Center

During amphibious operations, the intelligence sections of the ATF and the LF will generally integrate their operations. The principal intelligence C2 node afloat is the intelligence center located aboard the AF flagship. The intelligence center is composed of designated shipboard spaces with installed CIS systems that support the intelligence operations of the ATF and LF while reducing duplicative functions and producing more comprehensive and timely intelligence for the naval task force. Standard CIS connectivity is available (JWICS, SIPRNET, NIPRNET, AUTODIN, DSN). Access is provided via the flagship’s GENSER communication center and the special intelligence communications center within the intelligence center’s ship’s signals exploitation space.

CVBGs/TARPS Squadrons

TARPS support to MAGTF operations requires no unique CIS support. Most often, TARPS imagery is delivered to the intelligence center located aboard the AF flagship via courier. Processed TARPS imagery may be digitized and disseminated to the ATF and LF via JDISS, JWICS or the Global Command and Control System-Maritime.

MEF Command Element

Combat Intelligence Center

The CIC and its subordinate elements are the principal MAGTF intelligence C2 node providing

the facilities and infrastructure for the centralized direction for the MEF's comprehensive intelligence, CI, and reconnaissance operations. Since the CIC must effectively support the entire MEF, it must remain responsive to the requirements of all elements of the MAGTF. Supporting this objective, the CIC integrates and supports both MEF G-2 section and intel bn operations. While integrated, the organizational approach differs for each of these. The CIC is the overarching intelligence operations center established within the MEF main command post. It encompasses the primary functions of the MEF intelligence section and intel bn. The CIC includes the subelements listed in table 4-1.

Table 4-1. MEF CE CIC and Intel Bn's IOC Key Elements.

Element	Responsibilities
G-2 Plans	Serves as the G-2 section's main element for coordinating and providing intelligence support to the MEF CE future plans team and leadership and direction of the G-2 section's imagery and mapping, SIGINT, and weather sections.
G-2 Operations	Serves as the G-2 section's main element for coordinating and providing intelligence support to the MEF CG, battle staff, and current operations center elements; target intelligence support to the force fires and future operations; G-2 section intelligence requirements management activities; red cell support; and MEF intelligence liaison with external commands and organizations.
IOC	Serves as the principal MEF intelligence operations and C2 center that is established by intel bn; performs intelligence requirements management, staff cognizance of ongoing organic and supporting collection operations, intelligence production and analysis, and intelligence dissemination.
● Support Cell	Serves as primary element for conducting MEF-wide intelligence requirements management, weather support, collections and dissemination planning and direction, and intelligence staff cognizance of MEF organic and supporting intelligence and reconnaissance operations.
● P&A Cell	Serves as the primary production and analysis element of the MEF; processes and produces all-source intelligence products in response to requirements of the MEF; serves as the principal IMINT and GEOINT production element of the MEF.
● SARC	Serves as the primary element for the supervision of MEF collection operations; directs, coordinates, and monitors intelligence collection operations conducted by organic, attached, and direct support collection assets.
CI/HUMINT Company Command Post	Serves as the primary element for conducting CI/HUMINT planning and direction, C2, and coordination of MEF CI/HUMINT operations with external CI/HUMINT organizations.
Operations Control and Analysis Center	Serves as the main node for the C2 of radio battalion SIGINT operations and the overall coordination of MEF SIGINT operations; processes, analyzes, produces, and disseminates SIGINT-derived information; and directs the ground-based electronic warfare activities of the radio battalion.
Reconnaissance Operations Center	Serves as the main node for the C2 of force reconnaissance company's operations and the overall coordination of MEF ground reconnaissance operations; processes, analyzes, produces, and disseminates ground reconnaissance-derived information in support of MEF intelligence requirements.

The key G-2 nodes are organized to effectively align and support the MEF CE's staff cross-functional cellular staff organization (see figure 4-6) and concept of operations. The G-2 plans branch provides intelligence support to the MEF CE's future plans cell efforts. The G-2 operations branch provides intelligence support to the MEF CE's COC, FOC, force fires center and directs and manages the G-2's red cell and the MEF's external intelligence liaison teams.

CIC facilities, CIS, and other support must allow the AC/S G-2 and G-2 section to perform the following major tasks:

- Developing and answering outstanding MEF and subordinate units' PIR and IRs by planning, directing, integrating, and supervising MEF organic and supporting intelligence, CI, and reconnaissance operations.

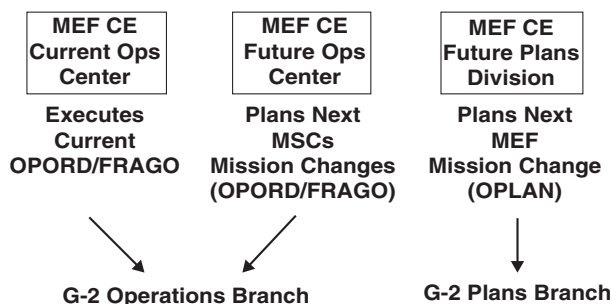
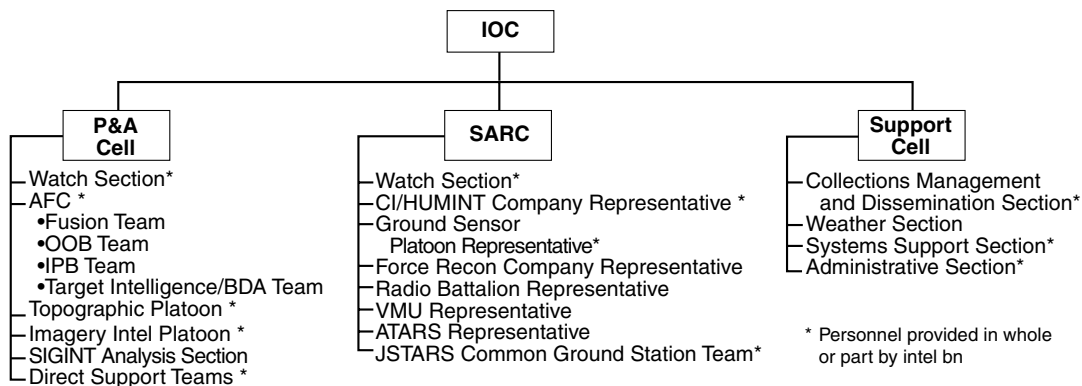

Figure 4-6. MEF CE Cross-Functional Cellular Organization and Intelligence Support.

- Planning the MEF concept of intelligence operations for approval by the AC/S G-2 and subsequent implementation by the ISC based upon the mission, threat, commander's intent, guidance, and concept of operations.
- Recommending CI and force protection measures and countermeasures.
- Preparing appropriate intelligence plans and orders for the MEF, to include reviewing, coordinating, and integrating the intelligence plans of JTFs, combatant commands and other organizations.
- Coordinating, providing, and facilitating the use of intelligence to the MEF CG, the battlestaff, the future plans cells, the FOC, the COC, and the force fires center.
- Planning, directing, and supervising MEF liaison teams to external commands (e.g., the JTF and joint functional components headquarters) and intelligence organizations.
- Coordinating and supervising the transition of intelligence planning and operations from G-2 plans to G-2 future operations, and from G-2 future operations to G-2 current operations, to effectively support the MEF's single battle transition process.

Intelligence Operations Center

The IOC is the other principal MEF CE intelligence node. The key subordinate elements within the IOC and their typical composition are the support cell, the SARC, and the P&A cell (see figure 4-7). It provides



* Personnel provided in whole or part by intel bn

Figure 4-7. Intelligence Operations Center Elements and Composition.

the facilities, CIS, and other support to allow the ISC and intel bn to perform the following tasks:

- Provide centralized direction for MEF intelligence operations under the staff cognizance of the AC/S G-2. The IOC is the core for this task, with key assistance from the G-2 plans and G-2 operations elements.
- Consistent with the commander's priorities, consolidate, validate, and prioritize IRs of the entire force. The key element providing this is the CMD section within the IOC's support cell. Intelligence specialists from all disciplines, to include IMINT, generally are organic to this section.
- Plan, develop, and direct the MEF collection, production, and dissemination plans and operations. The key elements providing for this are the CMD section within the IOC's support cell and the P&A cell.
- Submit consolidated requests for external intelligence support through the Marine component headquarters to appropriate agencies. The key element providing this is the CMD section within the IOC's support cell, assisted by the P&A cell and the G-2 operations branch.
- Allow ISC to exercise, per AC/S G-2 cognizance, principal staff cognizance of MEF organic and supporting intelligence, CI and reconnaissance operations, to include SIGINT, IMINT, HUMINT, GEOINT, CI, measurement and signature intelligence (MASINT), ground reconnaissance, and aerial reconnaissance operations.
- Coordinate and manage the employment of MEF organic collection assets through the IOC's SARC. Within the SARC will be representatives from most organic and supporting intelligence and reconnaissance units to provide C2 and reporting of ongoing intelligence operations.
- Maintain a consolidated, all-source intelligence production center in the P&A cell. Intelligence specialists from all intelligence disciplines generally are organic to the P&A cell. The other node with significant intelligence production involvement is the radio battalion's OCAC.
- Link the MEF CE to national, theater, joint, other-Service, and multinational intelligence assets and operations. All intel bn and G-2 section nodes have common and unique capabilities to perform critical tasks within the function. In addition to MEF CE common communications pathways provided by the communications battalion, the IOC generally will also have unique intelligence communications capability, such as TS II.

CIS Support

CIS support to CIC and IOC operations vary from operation to operation based upon METT-T. Generally all nodes will have access to IAS and JDISS (each with COLISEUM and other specialized applications) and connectivity with the full range of communications (JWICS, SIPRNET, NIPRNET, DSN, defense message system, voice, video-teleconferencing, etc.) via either MEF CE common communications or unique intel bn CIS capabilities. Examples of unique intelligence CIS capabilities are those integral to the VMU squadron RRS, the radio battalion technical control and analysis center and the AN/MSC-63A special security communications central, the ground sensor platoon's tactical remote sensor system, the IIP's TEG, the Marine tactical electronic warfare squadron's tactical electronic reconnaissance processing and evaluation system, the CI/HUMINT automated tool set, Manpack SIDS, TS-II, and the JSTARS CGS. See figure 4-8 for a notional depiction of an overarching MEF intelligence CIS architecture.

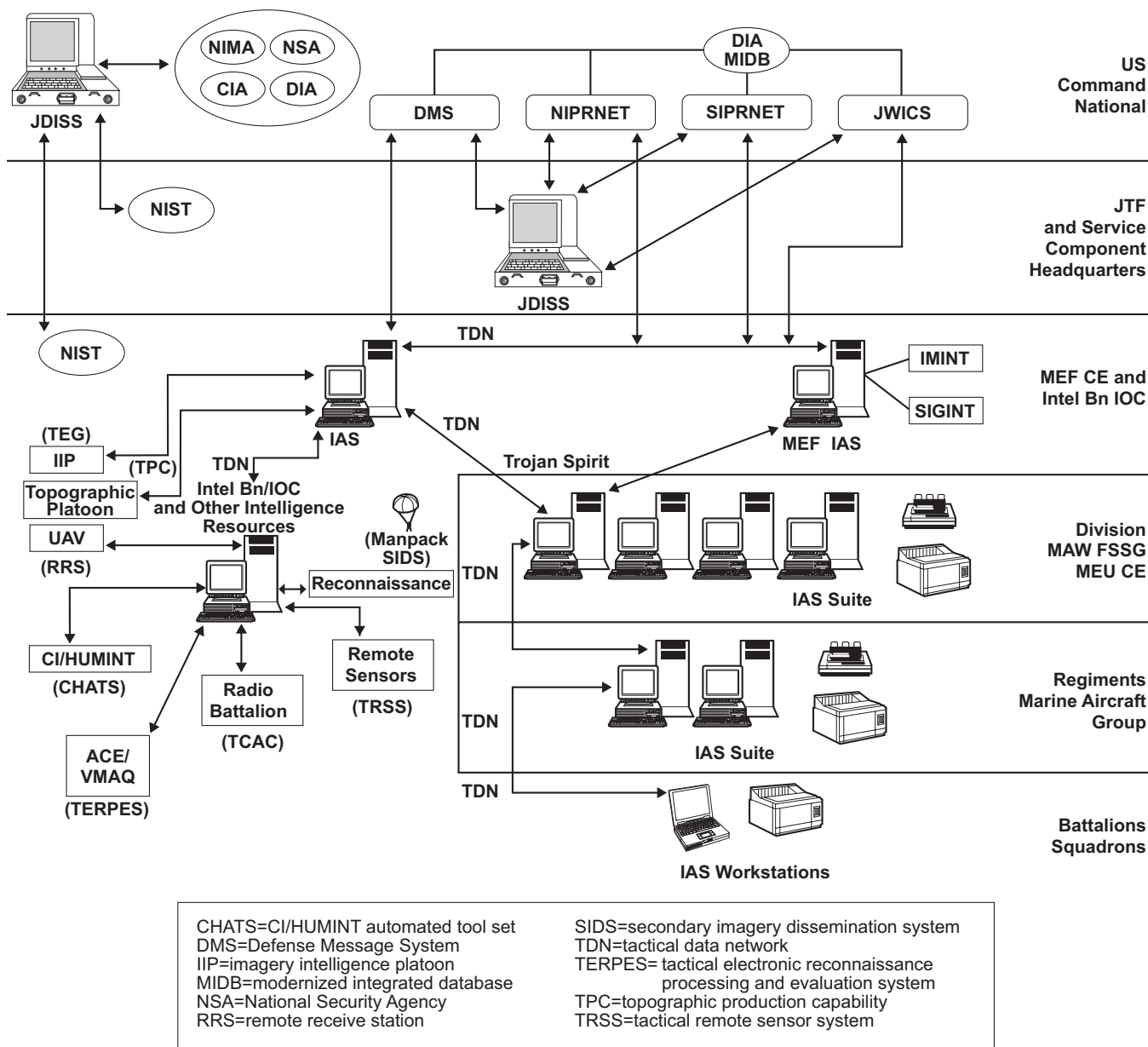

Figure 4-8. Notional MEF Intelligence Communications and Information Systems Architecture.

Overall MEF Intelligence C2 Relationships

The MEF G-2 section and intel bn’s overall C2 relationships and resulting all-source intelligence support flow throughout the MEF are indicated in figure 4-9 on page 4-12.

CIC/IOC Operations and IMINT

IMINT activities will be integral to many CIC/IOC operations.

Key activities include:

Collection. The CMD section, headquarters, intel bn, provides the core for MEF CIC collection operations. During operations the CMD section is located within the IOC’s support cell. Intelligence specialists from all disciplines, to include IMINT, are organic to this section. Key CIS resources required included IAS (with COLISEUM and other specialized applications) and access to the full range of communications: JWICS, SIPRNET, NIPRNET, DSN, etc.

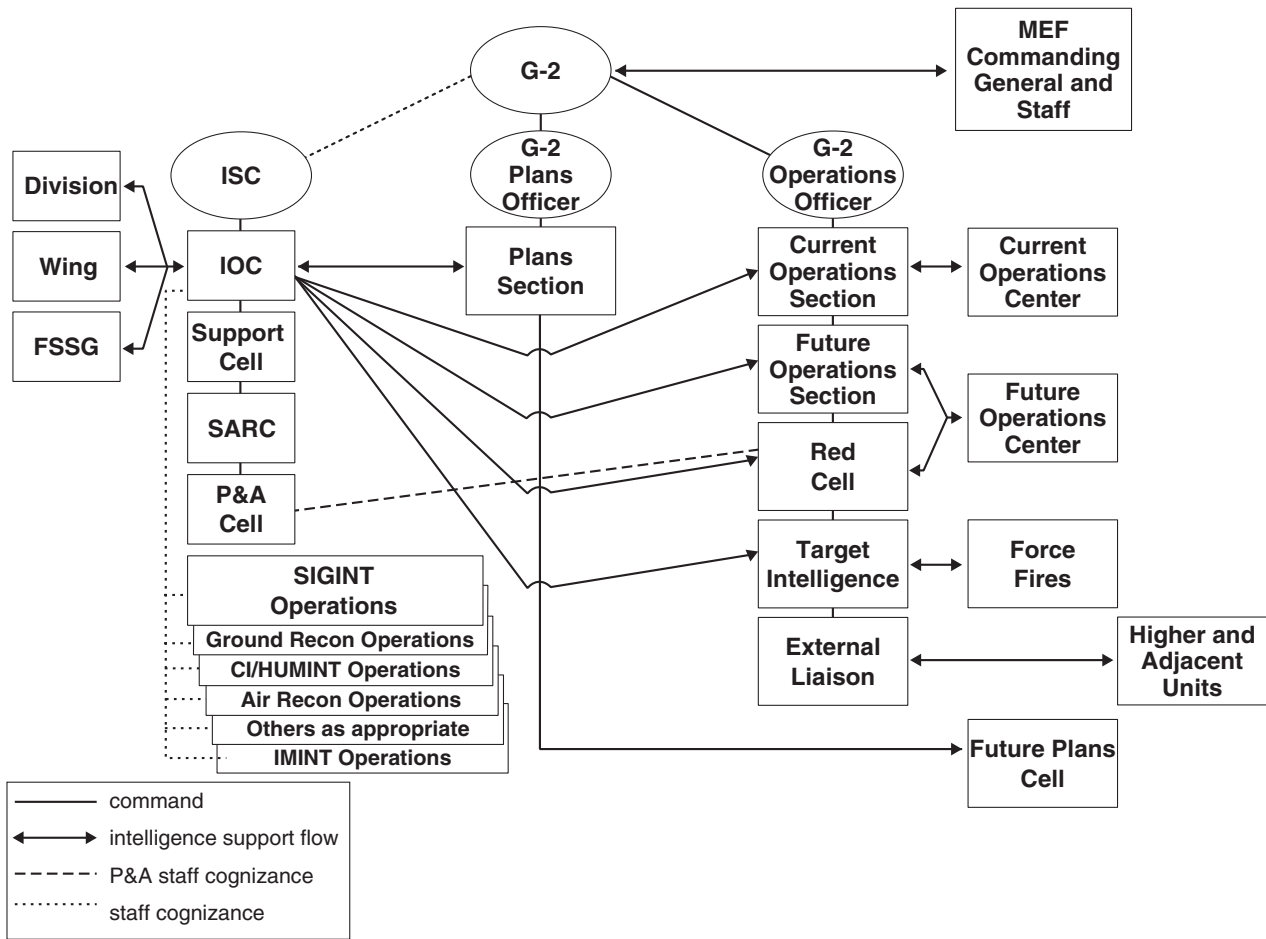

Figure 4-9. MEF Intelligence C2 Relationships and Intelligence Support Flow.

The SARC, another key element within the IOC, provides the other key component of collection operations. Within the SARC will be representatives from most organic and supporting intelligence and reconnaissance units to provide C2 and reporting of ongoing intelligence operations. Regarding IMINT, these representatives will include a UAV squadron element with supporting CIS resources to monitor ongoing UAV operations and report time-sensitive intelligence.

Production. The P&A cell, intel bn, provides the core for MEF intelligence production operations. Similar to collection, intelligence specialists from all intelligence disciplines are organic to the P&A cell. Key CIS resources required included IAS and JDISS, with access to the full range of communications (JWICS, SIPRNET, NIPRNET, DSN, etc.).

The IIP and intel bn generally will be integrated into P&A cell operations to efficiently support both IMINT and all-source production operations.

Dissemination. The CMD section, headquarters, intel bn, provides the core C2 for MEF intelligence dissemination operations. Key CIS resources required included IAS and JDISS, with access to the full range of communications (JWICS, SIPRNET, NIPRNET, DSN, etc.) for external dissemination; and IAS via the TDN and other MEF communications resources for internal dissemination.

The MEF CE will exploit all of the external capabilities discussed earlier to satisfy its IRs, with heavy reliance on the MCIA for national imagery support and the JIC/JAC for theater and national support. National imagery and related

products are received over dedicated terrestrial links that terminate at the MCIA's JSIPS National Dissemination Element (DE); standard communications connectivity from the deployed MEF to the MCIA via the DISN are normally provided by satellite communications. Currently, these links are predominantly super high frequency (X-Band) military SATCOM using GMF terminals. In the future, more C-Band and Ku-Band commercial SATCOM will be employed, using mobile Tri-Band SATCOM terminals. The limited capacity of these links to DISN remains a significant choke point for deployed MAGTFs. Efficient use of these links is critical to higher effective traffic throughput.

In addition to the MAGTF TDN and other common user communications capabilities, certain imagery units have specialized capabilities to support IMINT dissemination. The UAV squadron's RRS, attached to MEF MSEs (e.g., the MEF main effort), provides direct, time-sensitive UAV support.

Within the MEF, the IAS is the principal information system resource to support secondary imagery and other IMINT product dissemination. IAS will be available at all command echelons down to the maneuver battalion/squadron levels.

Communications connectivity between the MEF CE and its MSE headquarters are predominantly provided by SATCOM, supplemented where practical with terrestrial line-of-sight and troposcatter multi-channel radio systems. Connectivity to the regiment/group level is principally via the TDN (with current capabilities of between 16 and 32 kilobytes per second [kbps]) and various multichannel radio resources. Finally, communications connectivity below the regiment/group command echelon depends principally on single channel radio primarily designed for voice traffic, with limited range and limited data capacities (1.2 kbps to 16 kbps).

Although these units possess tactical data systems, their ability to exchange data traffic is currently limited due to the far less available bandwidth connectivity with the MAGTF TDN.

Imagery Intelligence Information Systems and Supporting Communications

Imagery Direction and Collection Management

IAS and the Requirements Management System (RMS) are the key automated information systems resources supporting MAGTF IMINT operations (see figure 4-10 on page 4-14).

Intelligence Analysis System

IAS is the principal intelligence information system tool. IAS automates MAGTF intelligence activities of direction, collection, processing, production, and dissemination of critical tactical intelligence from embedded databases and multiple sources. It is interoperable with JDISS and a wide range of other intelligence and reconnaissance systems. This allows for better identification and tracking of MAGTF IRs, and development and C2 of supporting collection, production, and dissemination activities, both within the MAGTF as well as with other services, JTF, theater, and national intelligence operations. Various configurations of IAS are fielded from the MEF CE through battalion and squadron command echelons. IAS contains a limited automated collection management tool for imagery, as well as for other organic intelligence collection.

Basic System. IAS is capable of communication and data exchange at both the GENSER and SCI levels via the MAGTF TDN. Composition and size will vary at each echelon, but the IAS essentially consists of data storage devices, workstations, and input/output devices. Workstations at all echelons will share common software applications.

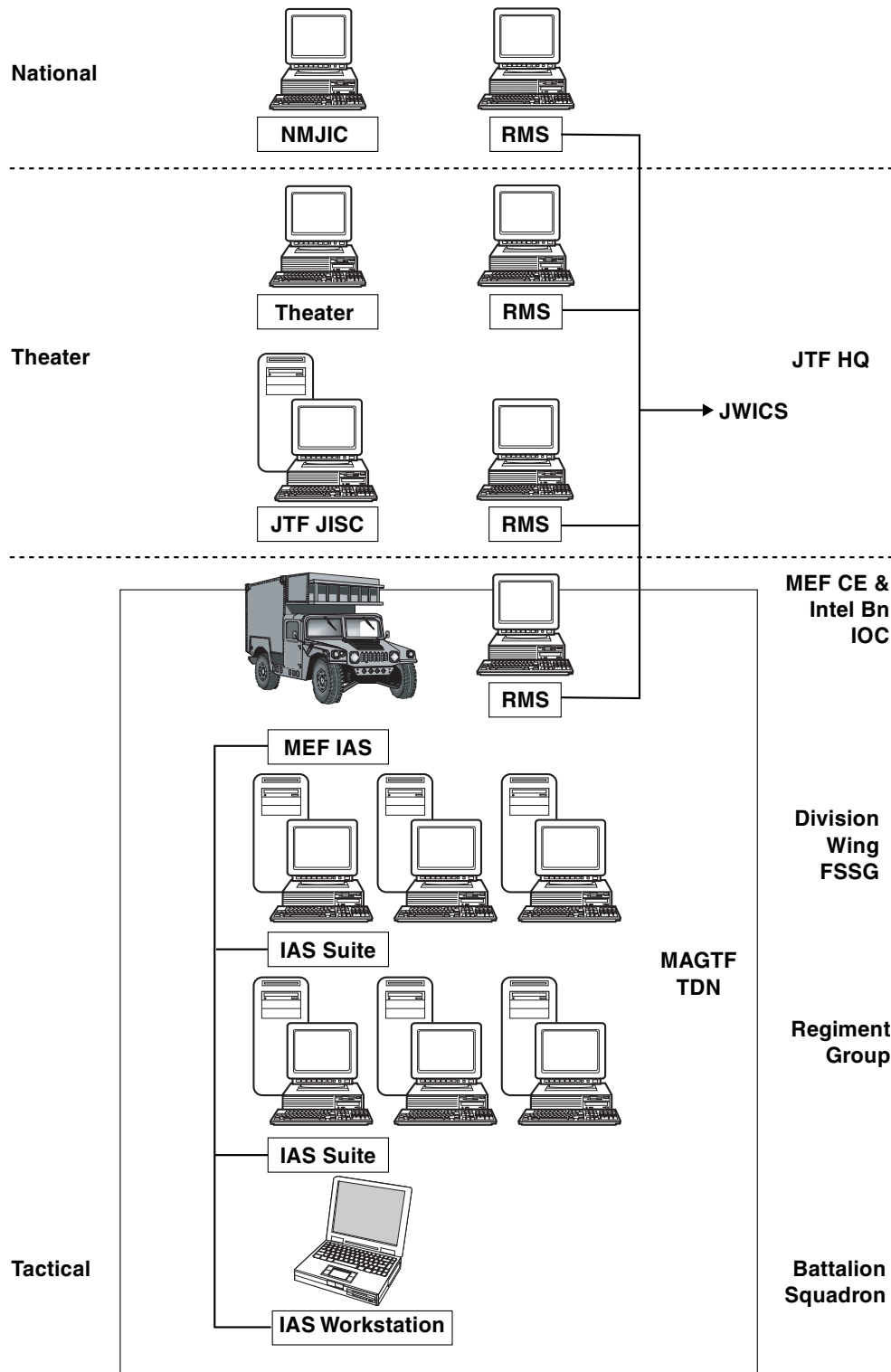

Figure 4-10. Imagery Direction and Collection Management.

Configuration. IAS consists of three configurations (see figure 4-11): MEF IAS, IAS suite, and the IAS workstation. The MEF IAS consists of two shelters mounted on HMMWVs and is used at the MEF CE level. The IAS suite consists of team portable equipment and will be used in the MEU CE and at division, MAW, regiment, and MAG headquarters. Finally, the IAS workstation consists of a single computer workstation and will be organic to battalion and squadron intelligence sections.

Features. The IAS provides connectivity and interoperability with most MAGTF intelligence, reconnaissance and other C2 systems, and with other services, JTF, theater and national intelligence organizations and data bases. IAS features improve the intelligence functions at all echelons of the MAGTF by providing a semi-automated all-source intelligence fusion center. It is capable of rapid access to and dissemination of critical, perishable tactical intelligence concerning terrain, weather, and enemy situation at all command levels. The IAS incorporates the capability to disseminate imagery throughout the MAGTF via

SIDS. It facilitates display, processing, analysis, preparation of intelligence products, and dissemination of intelligence products.

Requirements Management System

RMS provides the MAGTF and other users with a comprehensive national imagery collection management capability. RMS allows MEF collection managers to access the national imagery requirements tasking and tracking system (RMS terminals are also located at the MARFOR headquarters, MCIA Suitland and with the Marine Corps DRO). RMS users generate imagery requirements nominations interactively via networked RMS or RMS-supported workstations. The nominations are automatically transferred to the appropriate review authority, and upon validation and prioritization, taskings are transmitted by RMS to the collection, exploitation, production, and dissemination organizations.

System Configuration. RMS is an SCI-high system. The major components include a file server,

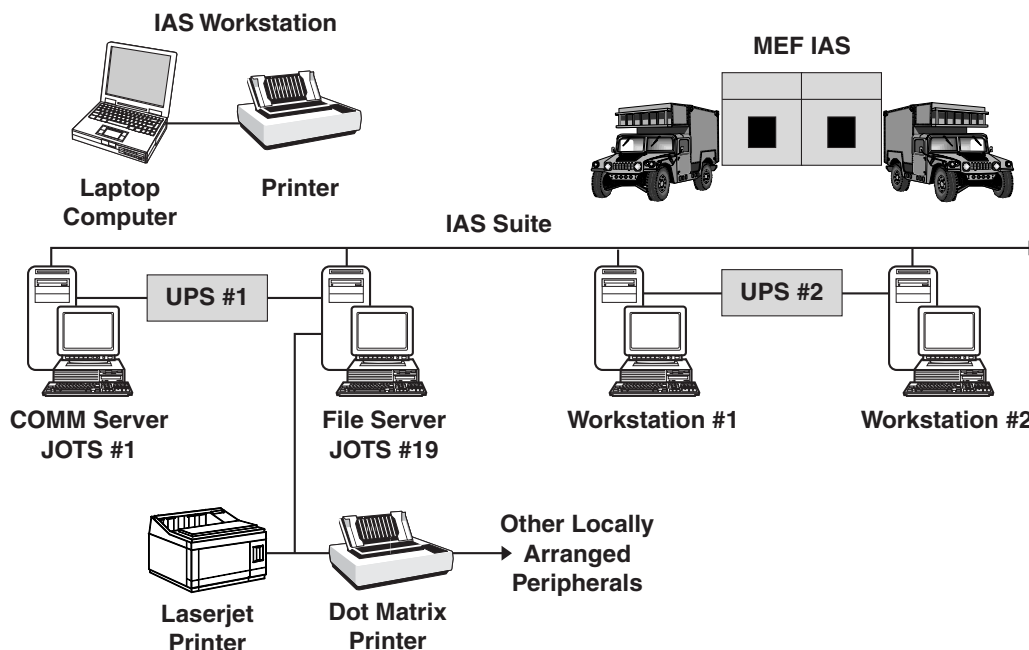

Figure 4-11. Intelligence Analysis System.

tape library system, access server for remote troubleshooting, a network laser printer, and the workstation itself.

RMS Connectivity. RMS communications connectivity requirements include JWICS and defense special security communications system (DSSCS).

Imagery Collection

The Marine Corps relies on both organic (see figure 4-12) and external collection assets for its imagery. The following paragraphs present MAGTF organic imagery collection assets and key C2-related information.

Advanced Tactical Airborne Reconnaissance System

The ATARS suites reside with the F/A-18D squadrons. ATARS-equipped F/A-18D aircraft will provide the MAGTF with organic manned aerial

imagery reconnaissance capability in support of IMINT operations. ATARS is capable of infrared, EO, and radar imagery collection, and provides high resolution, day and night imagery support in all weather conditions, through both overflight and long-range standoff. The F/A-18D’s long-range standoff capability is made possible with the installation of an upgraded, all-weather SAR system. Imagery is recorded and data-linked via integration with the ATARS sensor suite. The tactical interoperable ground data link (TIGDL) CDL will provide limited near-real time capability for dissemination of data on selected critical targets (down linked to the IIP’s TEG), with subsequent manual tape download for exploitation of the complete track. Figure 4-13 depicts the F/A-18D systems architecture.

Unmanned Aerial Vehicles

UAVs provide MAGTFs a valuable aerial reconnaissance and imagery (video and infrared) capability.

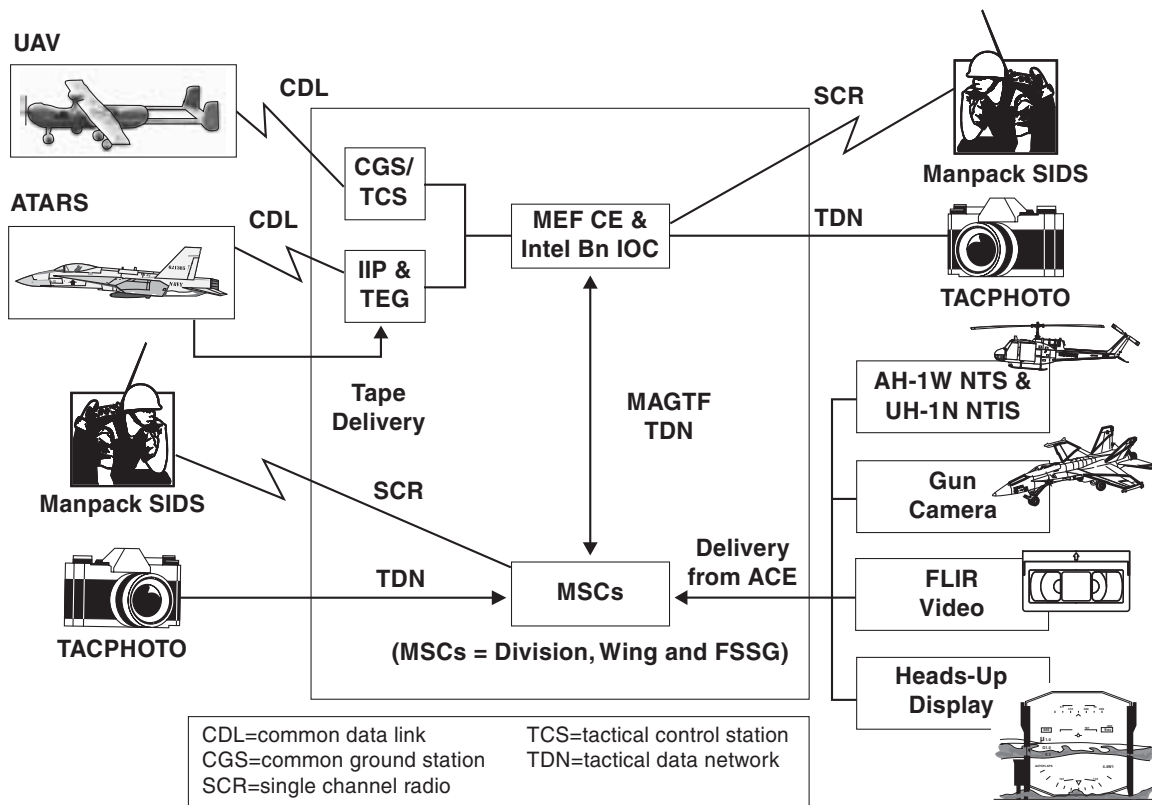

Figure 4-12. MEF Organic Imagery Collection.

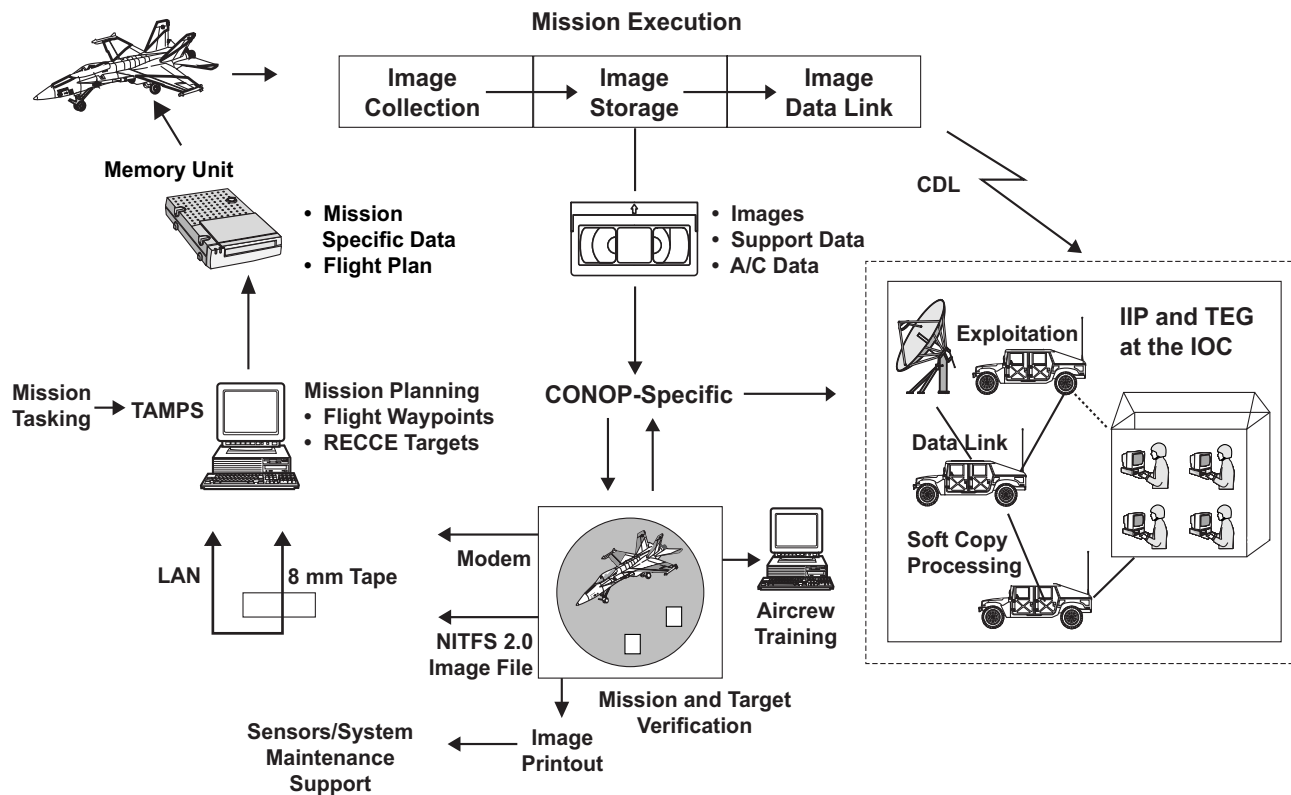

Figure 4-13. ATARS.

The Pioneer UAV resides in the VMU squadrons. Key UAV CIS resources are discussed in the following subparagraphs. See appendix D for additional information on UAV equipment and performance characteristics.

Ground Control Station 2000. The GCS-2000 is a small, modular, transportable control station for the UAV system. It controls and monitors the operations of the UAV and the installed payload. Since all pre-flight, takeoff, landing, post-flight, and maintenance procedures and functions can be performed from the GCS-2000, it can be used for controlling the UAV during all mission steps.

Portable Control Station. The portable control station (PCS) system—containing a flight control subsystem, a communications subsystem, and a power supply subsystem—allows UAV launch and recovery from a remote site, afloat or ashore, up to 40 kilometers from the GCS. The

PCS allows the external pilot to perform takeoff/landing and flight control until command of the UAV is transferred to the internal pilot in the GCS.

Tracking Control Unit. The TCU controls all UAV tracking and communication functions, manages all up and down link data processing, and performs preflight and system diagnostic tests. The TCU houses all internal communication equipment and antenna subsystems for the GCS and is slaved to it by remoting cables.

Remote Receiving Station. The RRS system is a miniature television receiver that can be attached or placed in direct support of commanders for real-time video pictures, supplemented with voice intelligence reports received from the GCS. There are two RRSs with each UAV system. Directional antennas allow video reception up to 30 kilometers from the UAV.

JSTARS Common Ground Station

Overview. The CGS is a mobile, tactical, multisensor ground station that provides the MAGTF CE with communications connectivity with the Air Force's E-8C and the capability to display, process, and disseminate acquired information. The CGS is organic to the MEF intel bn. Also receiving and processing MTI, FTI, and SAR data from the E-8C aircraft, the CGS is capable of receiving video data from UAVs, processed SIGINT from the Intelligence Broadcast Network, and secondary imagery from theater and national sources.

Basic System. The CGS is a HMMWV-mounted shelter system with component communications, computer, and mobile electric power systems. The CGS can be operated from either fixed positions or while mobile. Its crew of six operators

can set up or tear down this system in 30 minutes and can support continuous operations. The CGS features an open-system architecture that enables rapid insertion of the latest government and commercial off-the-shelf technology. The ultrahigh frequency (UHF) SCDL provides the digital communications connectivity between the E-8C JSTARS airborne element and the MAGTF CE G-2 section's CGS, enabling the transmission of MTI, SAR, and FTI data acquired by JSTARS to support MAGTF target acquisition, situation development, battlespace management, and targeting functions. Figure 4-14 depicts the JSTARS CGS MAGTF systems architecture and concept of operations.

Subsystems. The CGS is comprised of six subsystems: data communications group, sensor interface group, distributed data processing group,

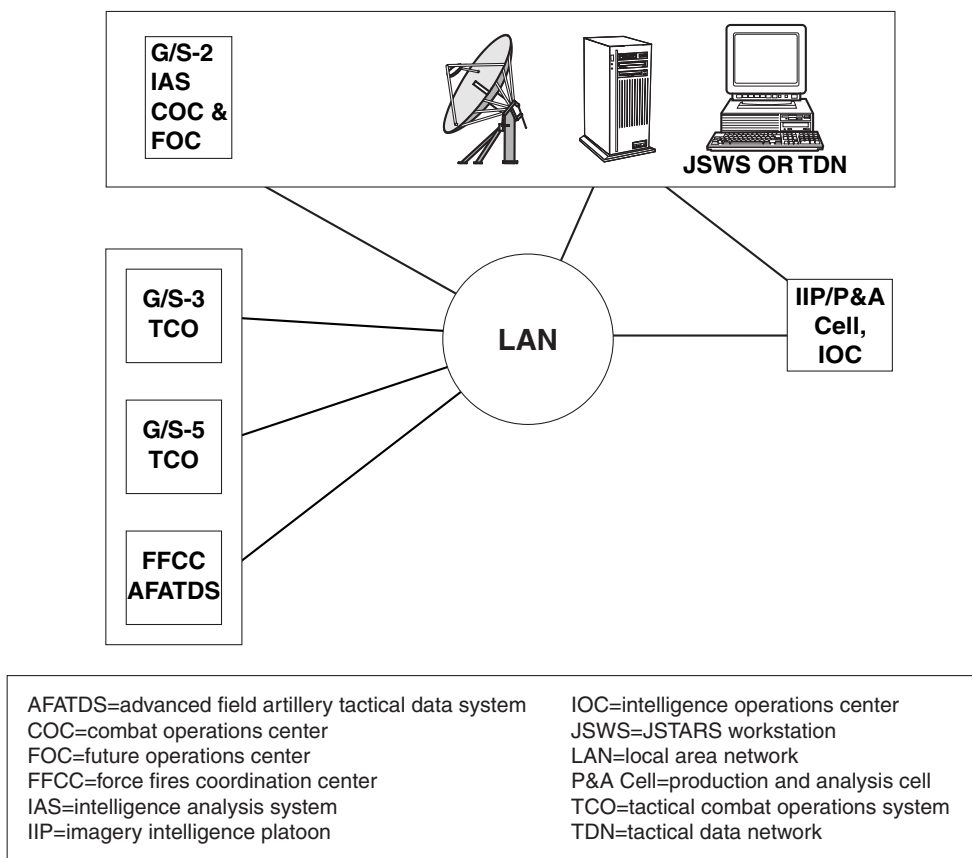

Figure 4-14. JSTARS and MAGTF Operations.

peripheral system group, voice communications group, and workstation group. CGS uses high performance CHS-2 SPARC 20 workstations, compatible with the MAGTF TDN.

Collection Capabilities. The E-8C carries a phased-array radar antenna in a 26-foot canoe-shaped radome under the forward part of the fuselage. The radar is capable of providing targeting and battle management data to all JSTARS operators, both in the aircraft and in the CGS module. These operators prepare intelligence reports or help coordinate aircraft, missiles or artillery fire support. With a range in excess of 155 miles, this radar covers an estimated 386,100 square miles in a single 8-hour sortie.

- **Wide Area Surveillance and Moving Target Indicator (WAS/MTI).** WAS/MTI are the radar's fundamental operating modes. WAS/MTI detects, locates, and identifies slow-moving targets. Through advanced signal processing, JSTARS can differentiate between wheeled and tracked vehicles. By focusing on smaller terrain areas, the radar image can be enhanced for increased resolution display. This high resolution defines moving targets and provides combat units with accurate information for attack planning.
- **Synthetic Aperture Radar/Fixed Target Indicator (SAR/FTI).** SAR/FTI produces a photographic-like image or map of selected geographic regions. SAR data maps contain precise locations of critical non-moving targets such as bridges, harbors, airports, buildings, or stopped vehicles. The FTI display is available while operating in the SAR mode to identify and locate fixed targets within the SAR area. The SAR and FTI capability used in conjunction with MTI and MTI history display allows post-attack assessments made by onboard or ground operators following a weapon attack on hostile targets.

Manpack SIDS

Overview. Manpack SIDS system provides the primary MAGTF capability for hand-held digital

imagery reconnaissance (see figure 4-15 on page 4-20). Manpack SIDS consists of three digital cameras, three palmtop processors, and a base station providing ground reconnaissance units with the capability to take pictures and send the images back to the base station over selected communications paths. The base station then disseminates the images to the supported unit's intelligence section's IAS for follow-on analysis, production, and dissemination via the MAGTF TDN or other CIS resources.

Concept. Manpack SIDS is a tactical hand-held digital imagery collection and dissemination system designed to acquire, store, manipulate, and electronically transmit images derived from ground reconnaissance patrols. The system is comprised of a man-transportable outstation camera with processor and a base station processor with printer. The outstation, with its digital camera component, will be employed by MAGTF ground reconnaissance elements during operations for image acquisition. Imagery collected by the outstation may be stored for subsequent analysis or electronically transmitted to the base station over organic tactical communications for more timely analysis and intelligence production. The base station will be located at the ROC for receipt, manipulation, annotation, and subsequent dissemination of imagery to other intelligence elements or direct to subordinate units in accordance with specified intelligence reporting criteria.

Components and Connectivity. Manpack SIDS consists of three manportable outstations and one base station. The outstation's primary components are a digital camera with three lenses and a palm top computer. In addition, there is one night vision device per system used with the camera in low light situations. The outstation also comes with cables that attach the camera to the palm top, and the palm top to the encryption device and radio. The base station is primarily made up from the lap top computer and thermal printer. It also comes with the cables required to connect with the encryption device and radio (it is interoperable with the PRC-104, PRC-113, single-channel ground and airborne radio system,

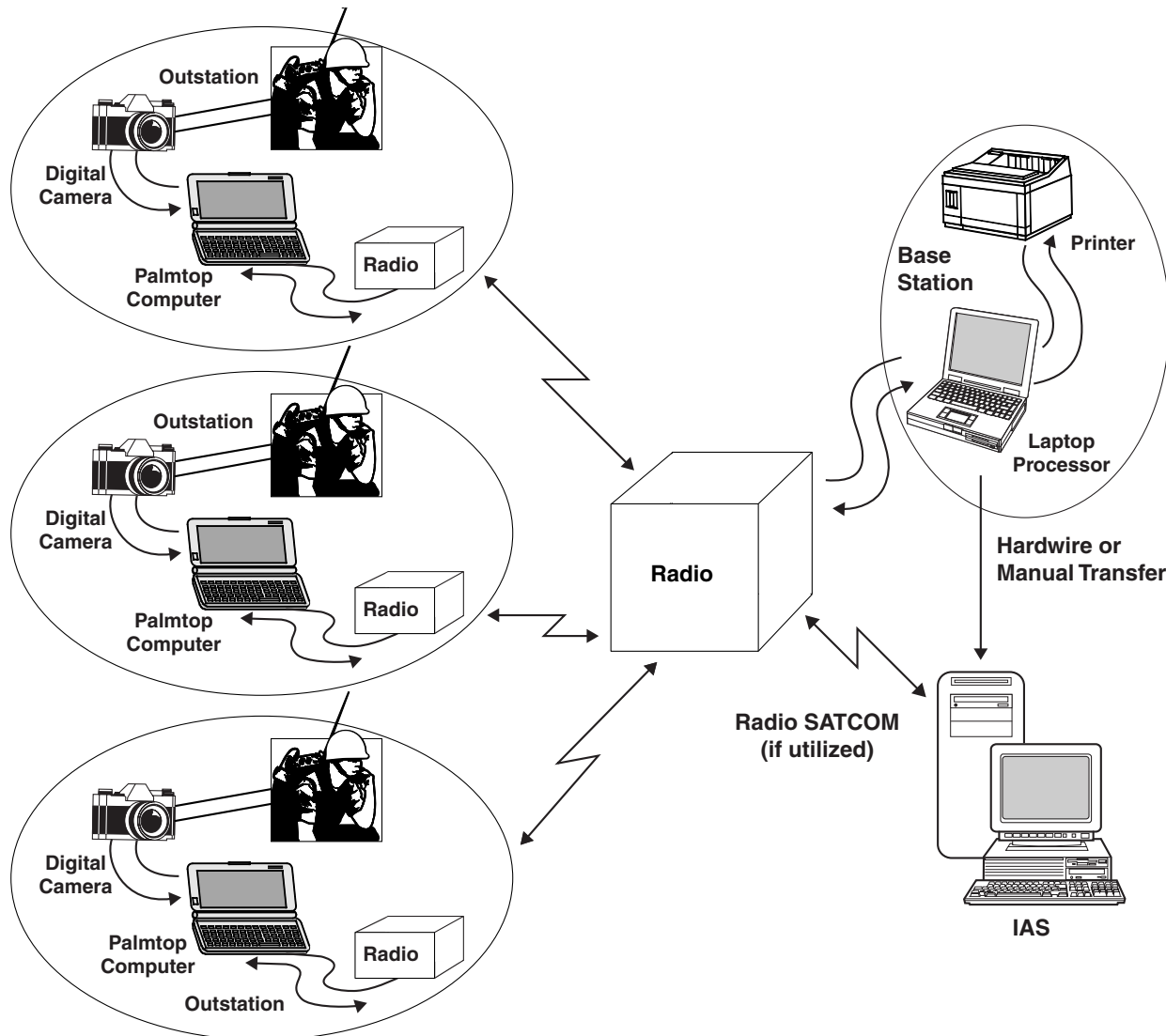

Figure 4-15. Manpack SIDS.

and various satellite communications resources). The base station is interoperable with the IAS via either the MAGTF TDN or other organic communications.

HML/A's NTS and NTIS

Components

- AH-1W Night Targeting System.** The NTS FLIR's linear scanning array consists of 120 mercury cadmium telluride detector elements that scan left to right, then right to left to interlace the image. Information is then doubled to provide 480 lines of information. The super videocassette recorder (SVCR) automatically starts recording when the laser designator or weapons firing is activated or through command from the crew, and records in both super very high speed (VHS) and standard VHS formats. Finally, the television tracker is a video autotracker that works with both video and FLIR modes.
- UH-1N Night Thermal Imaging System.** The NTIS components are similar to that of the NTS less the NTS's laser designator and television tracker capabilities. Its videocassette recorder (VCR) records only in standard VHS format.

Employment. The NTS and NTIS systems were fielded to provide the MAGTF with all-weather, day/night, autonomous attack, C2 and utility helicopter capabilities. Embedded within each system is a VCR to allow the aircrew to record engagements for debrief, collect BDA information, and to aid in target identification, acquisition, and engagement in a high threat environment while minimizing exposure time. The fielding of these systems greatly expanded the HML/A squadrons' traditional reconnaissance and surveillance capabilities because of their upgraded sensors and the VCR capabilities. However, the VCR does not record any other supporting information (e.g., geographic coordinates) beyond the basic imagery. Accordingly, helicopter aircrews will record concurrently an audio of the mission to make the tape more useful for post-mission debriefings and users.

Both helicopters, the AH-1W and UH-1N, can be employed in sections or as part of teams to scout ahead of friendly troops or to conduct visual and/or imagery reconnaissance of areas of interest, objectives, routes, point targets, etc. Because each is vulnerable to ground fire and provides other critical support to MAGTF (e.g., the AH-1W's fires capability; the UH-1N's C2 and utility capabilities), rarely will either be employed in a dedicated reconnaissance role. A more likely role for the AH-1W would be an armed reconnaissance mission as a function of offensive air support to deep air support operations. In such a mission the AH-1W would seek out and engage a given target set within a specified area, with a concurrent mission to collect intelligence data. Another likely mission for the AH-1W is armed interdiction, in which AH-1's would be deployed to engage a specific, known target and collect intelligence information.

Finally, both the AH-1W and UH-1N can be employed to conduct point or route reconnaissance missions of designated objective areas or by flying a route while video/FLIR recording to provide GCE, ACE or CSSE forces with a valuable early look at planned areas of operation.

All intelligence missions typically will be performed in addition to the primary missions of armed escort and rotary-wing close air support. During the conduct of any mission, both aircraft have a secondary mission of conducting aerial reconnaissance, and the aircrew would employ the NTS and NTIS to collect and store imagery data for post-mission follow-on analysis.

Tactical Photo

TACPHOTO is a digital camera system for units that normally return to base (i.e., flight crews, CI teams, and scout snipers), and have the capability to download acquired images into other intelligence information systems for follow-on intelligence exploitation. TACPHOTO uses the same digital camera and a similar concept of employment as Manpack SIDS. It consists of a digital camera, three lenses, PCMCIA card hard drive and card reader, cables, and the imagery receive and manipulate software.

Imagery Processing, Exploitation, and Production Capabilities

The Marine Corps possesses a limited organic imagery processing, exploitation, and production capability. Access to national, joint, theater, and other-Service processing and production capabilities will therefore be important elements of the Marine Corps imagery architecture (see figure 4-16 on page 4-22). The following provides descriptions of key IMINT processing, exploitation, and production information systems.

Dissemination Element

The MCIA's DE (formerly known as JSIPS) provides exploitation and dissemination of national imagery to MAGTFs and other Marine Corps units (to include the supporting establishment). The DE receives, stores, and exploits digital NRT imagery from national and theater imagery collection platforms. It also displays imagery in softcopy format for immediate exploitation. MCIA's intelligence, imagery, and database systems and requirements include defense message system,

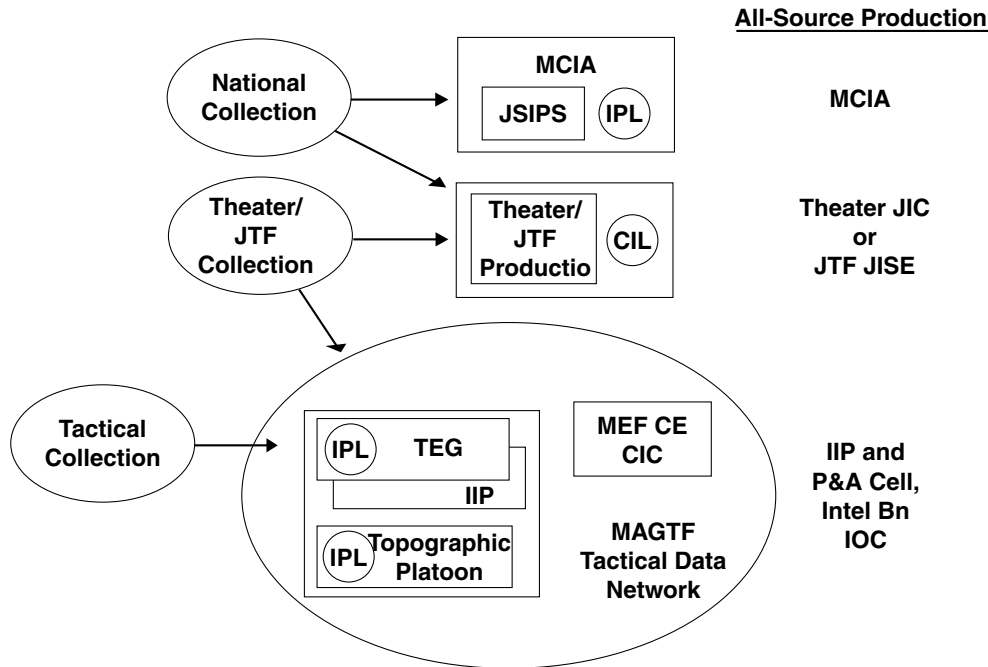

MCIA (which operates the JSIPS) and the IIPs (which will operate the TEG in each MEF architecture) are the Marine Corps' principal imagery and IMINT processing and production facilities. Within the MEF, the principal all-source intelligence processing and production agency is the Production and Analysis Cell, Intelligence Battalion.

Figure 4-16. MEF Imagery Processing and Production.

JWICS, SIPRNET, 5D imagery server or IPL, RMS, imagery exploitation software system (IESS) data base, and the NIMA Delivery System (NDS).

Tactical Exploitation Group

The TEG is a key MAGTF IMINT system and the only imagery exploitation and analysis tool available within the MEF (see figure 4-17). It is organic to each MEF's intel bn's IIP. It is capable of receiving, exploiting, and producing imagery and IMINT products and reports via its system architecture (see figure 4-18). The TEG provides the capability to receive, process, store, exploit, and disseminate imagery, to include ATARS EO, infrared, and radar imagery; U-2 SAR imagery; and secondary imagery products from the MCIA and theater JIC/JACs. Additionally, the TEG's equipment suite provides the capability to exploit film-based imagery and output from digital cameras such as Manpack SIDS, and heads-up displays, FLIR, and gun camera tapes from various tactical aircraft. Once received, processed, and

exploited, the imagery is then transmitted over available SIDS device(s), MAGTF TDN or other CIS resources. Upon fielding of the TIGDL CDL, NRT exploitation and processing of ATARS imagery will be possible; until then, imagery data tapes must be downloaded and disseminated to the TEG post-mission. Even with the TIGDL CDL, only selected priority images will be down linked; the remaining imagery data is stored on tape and downloaded following recovery.

The TEG is packaged in three HMMWVs and three trailers. Due to its weight and balance, the TEG requires additional external lift capability to move the IIP and TEG within the area of operations. This additional lift is not resident within the intel bn and must be provided either by the MEF headquarters group or some other external source.

The initial operational capability TEG allows for the processing of F/A-18(R/C) mission tapes and data link and handles preprocessed national, U-2, UAV, and digital camera systems imagery. The

**Vehicles and Power****Vehicle and Work Tent****Tactical Data Link****TEG Workstations****Figure 4-17. TEG Components.**

full capability TEG provides interoperability with all Common Imagery Ground/Surface Systems (CIGSSs) baseline sensors (e.g., ATARS, Global Hawk) and handles all other preprocessed national imagery transmission format (NITF) imagery data.

Image Product Library

The IPL is the migration system to replace the legacy 5D System. IPL supports the storage and dissemination of imagery and imagery products, providing a library of information to imagery customers worldwide. IPL uses a standard Intelink or Intelink-S client to provide user access to this library, and supports both data push and data pull, via user profiling. The IPL stores imagery in NITF 2.0, TIFF, and other graphical formats.

Libraries are composed of three types: product, command, and national. The three types are differentiated by content, storage size, performance, and responsibility for operations and management. They are alike in that each type may contain digital imagery or digital imagery products from all sources including tactical, theater, national, civil, and commercial collection systems. All libraries share common digital imagery standards.

IPLs contain shared, restricted, or both types of imagery and imagery products required to support individual organizations. Each organization will determine the population of and manage its IPLs. The imagery and imagery-based products consist of tactical, theater, national, civil, and commercial imagery and imagery-based products. Most of the data stored on IPLs will be imagery products with

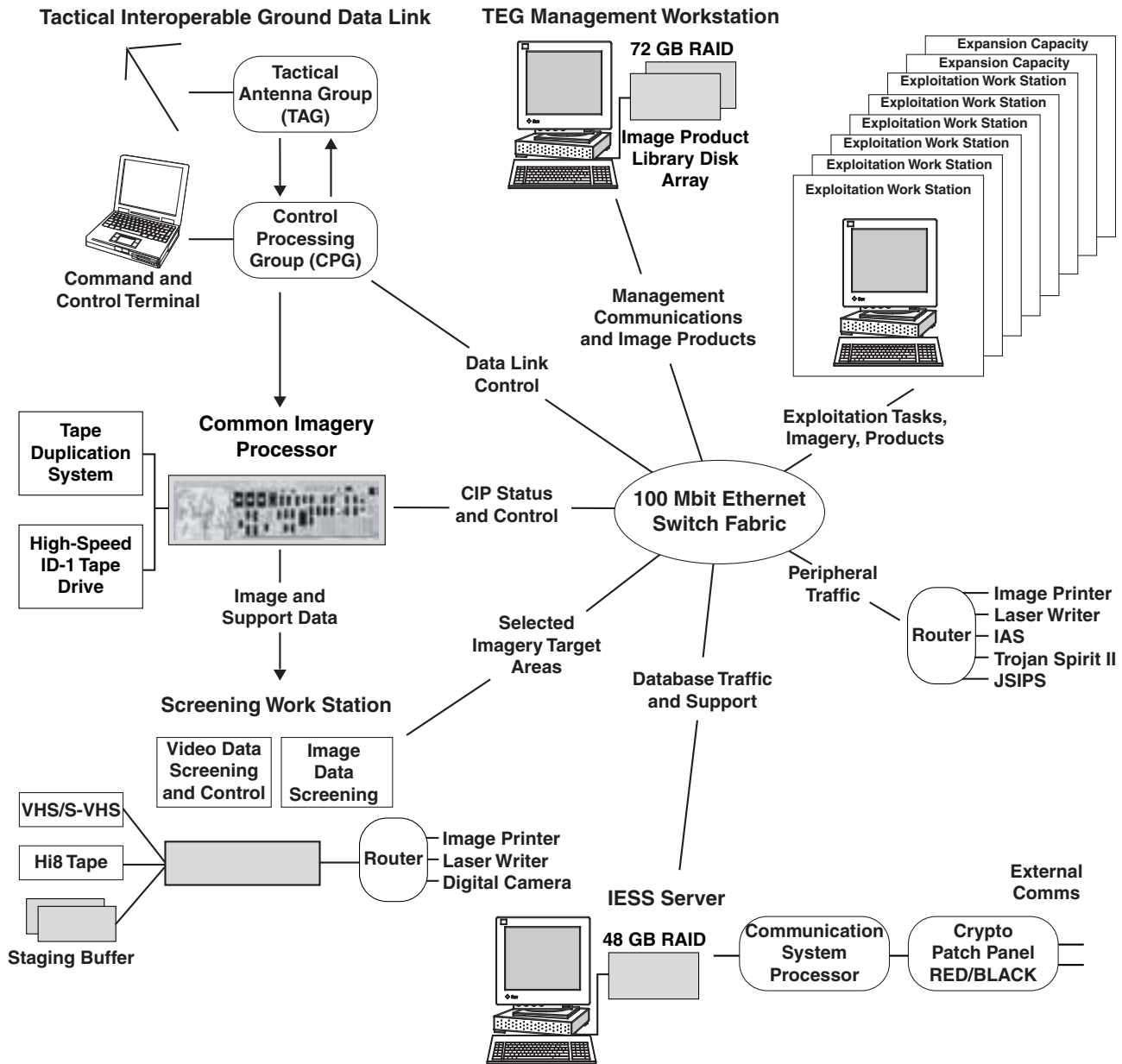

Figure 4-18. IIP/TEG Systems Architecture.

the owner determining the mix between imagery and imagery products, the size of their IPLs, their interfacing organizations, and the products requiring storage. NIMA will provide the updated IPL management software. IPLs are based upon existing 5D capabilities, scaled for size and performance, and some are portable. IPLs support various levels of command, CIGSS sites, and other organizations outside the command structure of the services requiring the use of libraries. When IPLs

are integrated into the 17+ CIGSS ground station architectures, processed tactical imagery (still or motion) is fed to an IPL, acting as an imagery buffer, at the ground station. Stored imagery is then pulled or pushed to the exploitation workstations, exploited, then sent to the public access IPL for dissemination.

IPLs will be capable of importing, storing, exporting and managing imagery, image-based

products, and associated metadata. IPLs have the capability to retain digital imagery data in on-line, near-line, and off-line storage media. Each IPL maintains a catalog populated with metadata of its imagery and imagery product holdings. The national IPL supports up to 1,300 image requests per day and up to 900 gigabytes (GB) for on-line imagery storage. The IPL should not take longer than 8 minutes to transfer a full frame (930 megabytes [MB]) national image to any requesting client (assuming fiber distributed data interface and no LAN contention).

Figure 4-19 provides a broad depiction of the services, applications, and scope within the IPL.

Imagery CIS Architecture

Figures 4-20 on page 4-26 and 4-21 on page 4-27 summarize the information discussed throughout

this chapter and depict the internal IMINT CIS architecture for a MEF, and the broader IMINT CIS architecture through the theater and national levels.

IMINT Communications and Information Systems Planning Considerations

The following identifies key CIS requirements and planning considerations in support of MAGTF IMINT operations.

- Ensure that the MAGTF CE, IIP elements, and other MAGTF units are included in the distribution of IMINT-related address indicator groups to receive pertinent JTF, Navy, theater, and national intelligence and IMINT products.
- Determine and coordinate radio net requirements, supporting frequencies, and operational

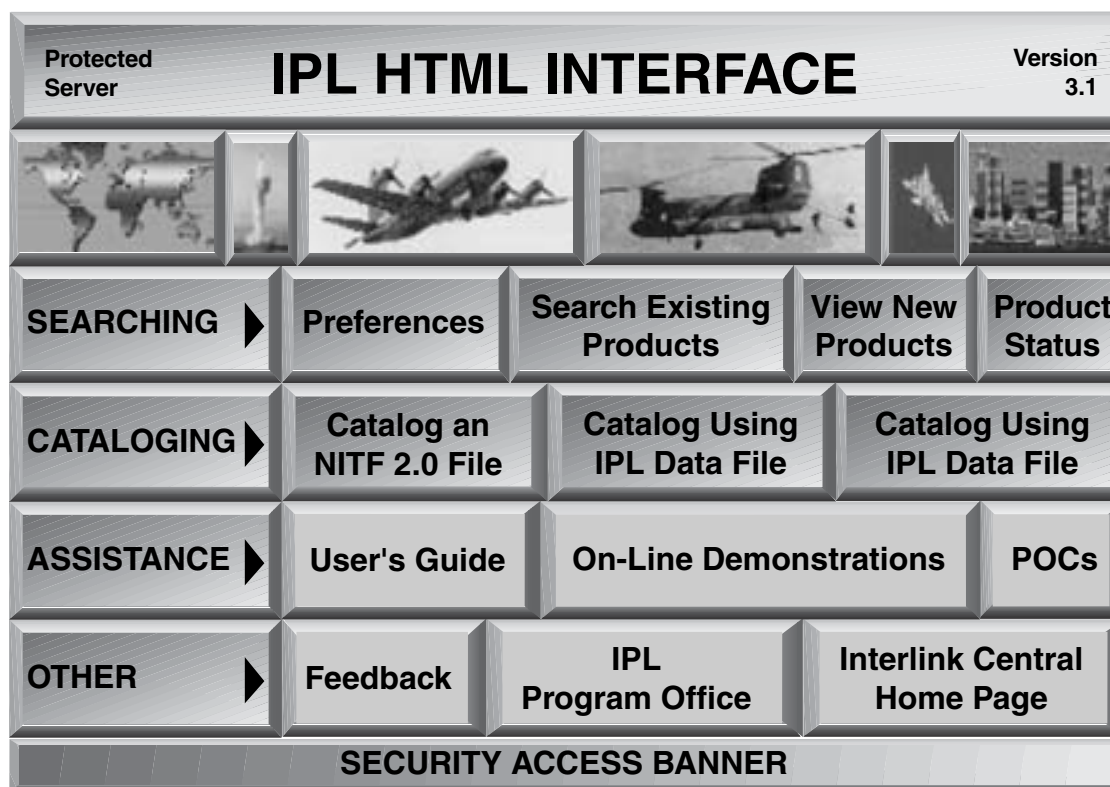

Figure 4-19. Image Product Library.

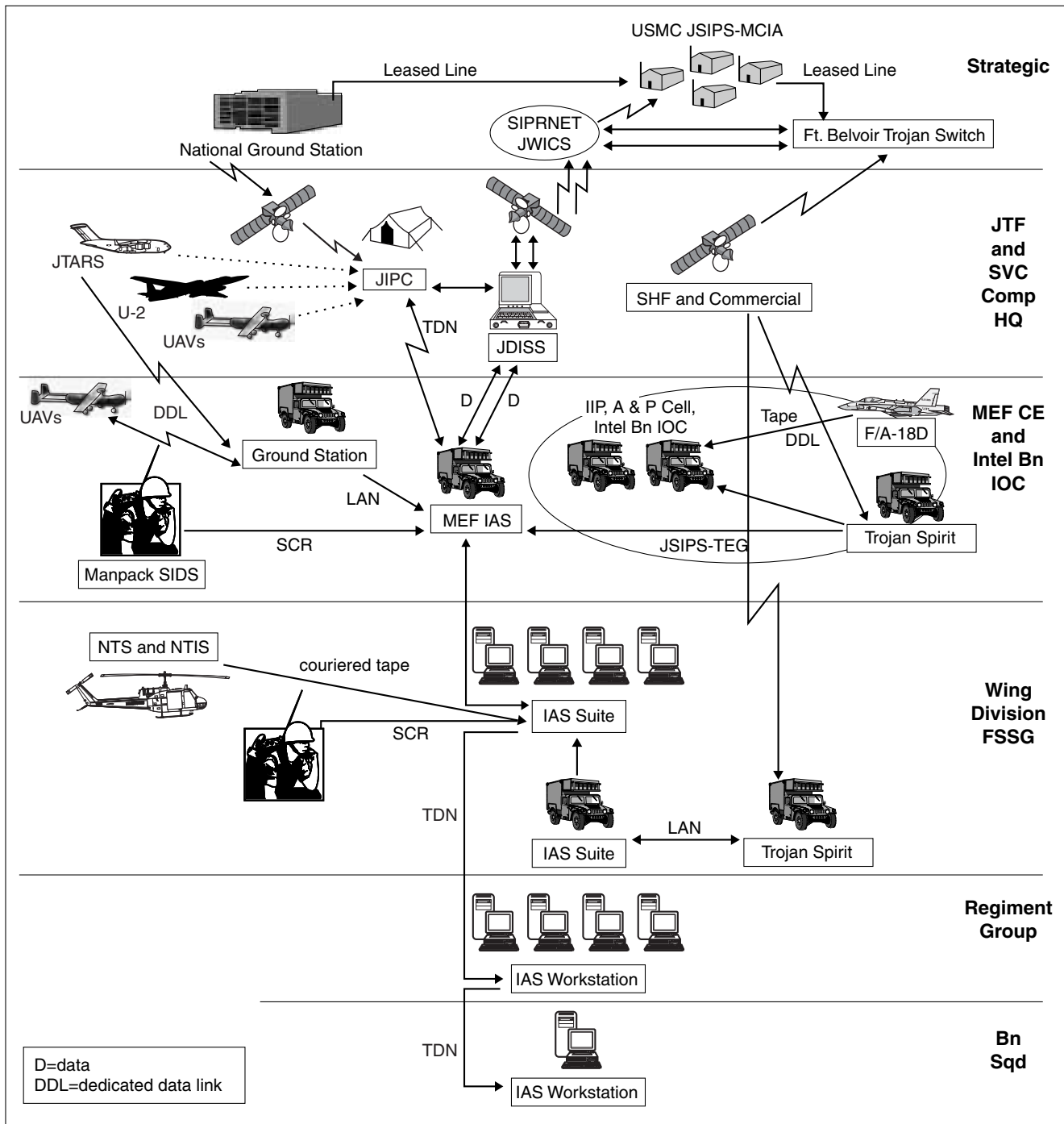

Figure 4-20. MEF Internal Imagery CIS Intelligence Architecture.

- procedures in support of IMINT operations (external to MAGTF, internal MAGTF, intelligence broadcasts, retransmission sites, routine and time-sensitive operations, etc.).
- Coordinate IMINT CIS activation and restoration priorities and supporting procedures.

- Establish, operate, and manage unique IMINT communications requirements (e.g., with MCIA for the JSTARS CGS).
- Identify and procure communications security materials system (CMS) requirements for unique IMINT communications.

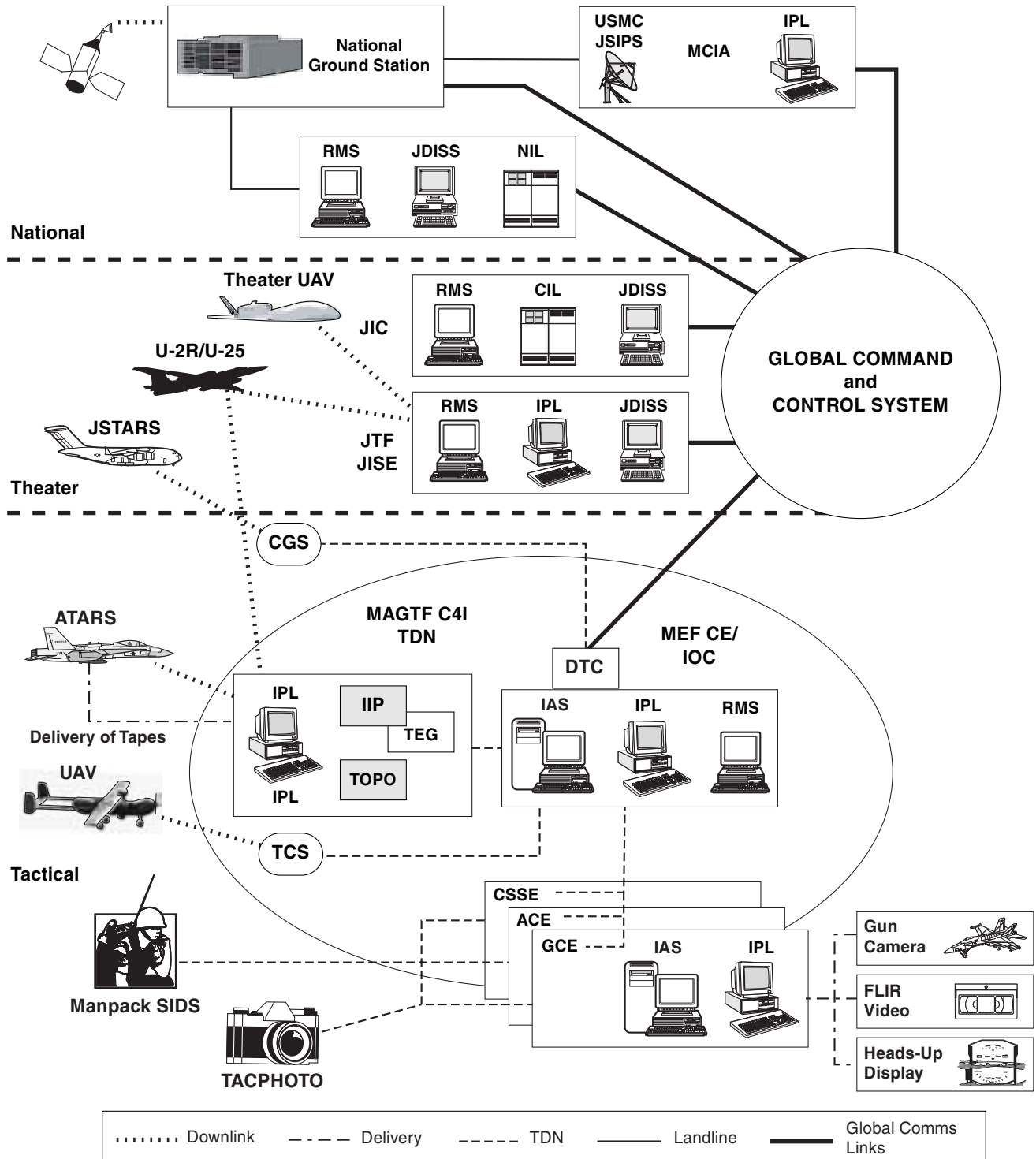

Figure 4-21. MEF Through National IMINT CIS Intelligence Architecture.

- Determine and coordinate wire communications (to include telephones) supporting IMINT operations.
- Determine and coordinate LANs and WANs and unique intelligence network information systems requirements in support of IMINT operations (hardware, software, internet protocol addresses, etc.).
- Integrate MAGTF IMINT elements' CIS operations with those of other MAGTF and pertinent JTF and other components intelligence and reconnaissance units (mutual support, cueing, etc.).
- Integrate CIS of IMINT elements employed in general support with collocated GCE, ACE, CSSE, and other MAGTF elements (e.g., integration of UAV squadron RRS with supported GCE units to provide time-sensitive reporting, coordination of maneuver).
- Coordinate MAGTF IPL and Manpack SIDS administration and operations.
- Coordinate IMINT CIS and collection, production, and dissemination operations and procedures with other Services', allied and coalition forces' IMINT and all-source intelligence operations.

CHAPTER 5. OPERATIONAL PLANNING AND EXECUTION

Whether performed at the national or the battalion/squadron level, the key functions of planning are—

- Lead to a plan that directs and coordinates action.
- Develop a shared situational awareness.
- Generate expectations about how actions will evolve and how they will affect the desired outcome.
- Support the exercise of initiative.
- Shape the thinking of planners.

Marine Corps Planning Process

The Marine Corps Planning Process (MCP) helps organize the thought processes of a commander and the staff throughout the planning and execution of military operations. The MCP focuses on the threat and is based on the Marine Corps warfighting philosophy of maneuver warfare. It capitalizes on the principle of unity of effort and supports the establishment and maintenance of tempo. The MCP steps can be as detailed or as abbreviated as time, staff resources, experience, and the situation permit. The command and staff actions at all echelons must apply the MCP. From the Marine Corps component headquarters to the battalion/squadron level, commanders and staff members must master the MCP to be full participants in integrated planning. Additionally, the MCP complements deliberate or crisis action planning (CAP) as outlined in the Joint Operation Planning and Execution System (JOPES).

The MCP establishes procedures for analyzing a mission, developing and analyzing courses of action (COAs) against the threat, comparing friendly COAs against the commander's criteria and each other, selecting a COA, and preparing an OPORD for execution.

The MCP organizes the planning process into six steps (see figure 5-1).

The MCP provides the commander and the commander's staff a means to organize their planning activities and transmit the plan to subordinates and subordinate commands. Through this process, all MAGTF levels of command can begin their planning effort with a common understanding of the mission and commander's guidance. The six integrated steps of this process follow.

Mission Analysis

Mission analysis is the first step in planning. Mission analysis reviews and analyzes orders, guidance,

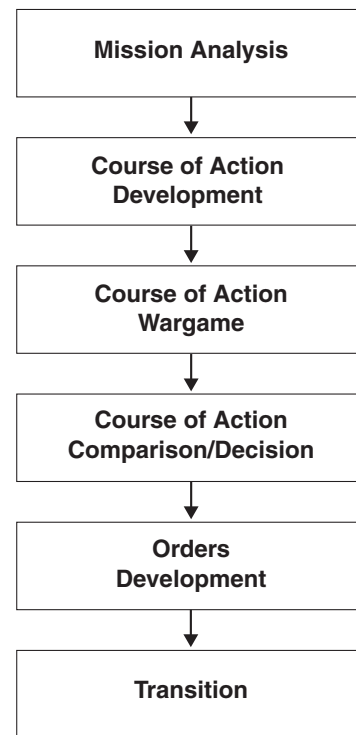

Figure 5-1. The Marine Corps Planning Process.

and other information provided by higher headquarters and produces a unit mission statement. Mission analysis drives the MCPP.

COA Development

During COA development, the planners use the mission statement including higher headquarters tasking and intent, commander's intent, and commander's planning guidance to develop the COA(s). Each prospective COA is examined to ensure that it is suitable, feasible, distinguishable, acceptable, and complete with respect to the current and anticipated situation, the mission, and the commander's intent. In accordance with the commander's guidance, approved COAs are further developed in greater detail.

COA Wargaming

COA wargaming involves a detailed assessment of each COA as it pertains to the enemy and the battlespace. Each friendly COA is war-gamed against selected threat COAs. COA wargaming assists the planners in identifying strengths and weaknesses, associated risks, and asset shortfalls for each friendly COA. COA wargaming identifies branches and potential sequels requiring additional planning. COA wargaming provides the most reliable basis for understanding and improving each COA.

COA Comparison and Decision

In COA comparison and decision, the commander evaluates all friendly COAs—against established criteria, then against each other—and selects the COA deemed most likely to accomplish the mission.

Orders Development

During orders development, the staff takes the commander's COA decision, mission statement, commander's intent, and guidance and develops

orders to direct the actions of the unit. Orders serve as the principal means where the commander expresses decision, intent, and guidance.

Transition

Transition is an orderly handover of a plan or order as it is passed to those tasked with execution of the operation. It provides those who will execute the plan or order with the situational awareness and rationale for key decisions necessary to ensure there is a coherent shift from planning to execution.

Interactions among various planning steps allow a concurrent, coordinated effort that maintains flexibility, makes efficient use of time available, and facilitates continuous information sharing. Appendix F captures major IMINT planning considerations and activities in support of MAGTF operations, cross-referencing each with the MCPP step and major staff planning activities that they are most associated.

Joint Planning Processes

Joint Deliberate Planning

The deliberate planning process is used by the joint staff and combatant commanders to develop plans in support of national strategy. The Joint Strategic Capabilities Plan (JSCP) apportions forces and resources for use during deliberate planning by the combatant commanders and their Service component commanders. Figure 5-2 illustrates how the MCPP fits within and supports the joint deliberate planning process.

Crisis Action Planning

CAP is conducted in response to crises where national interests are threatened and a military response is being considered. In CAP, the time available for planning at the national level may

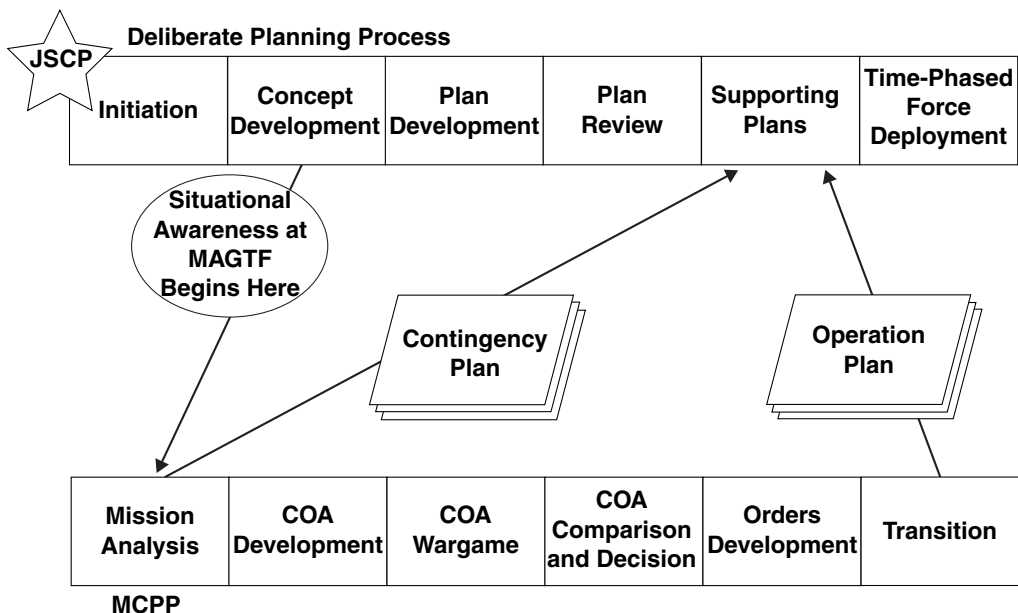

Figure 5-2. The MCPP and the Joint Crisis Action Planning Process.

be reduced to as little as a few days. CAP procedures promote the logical, rapid flow of information and the timely preparation of campaign plans

or OPORDs. Figure 5-3 illustrates how the MCPP fits within and supports the joint crisis action planning process.

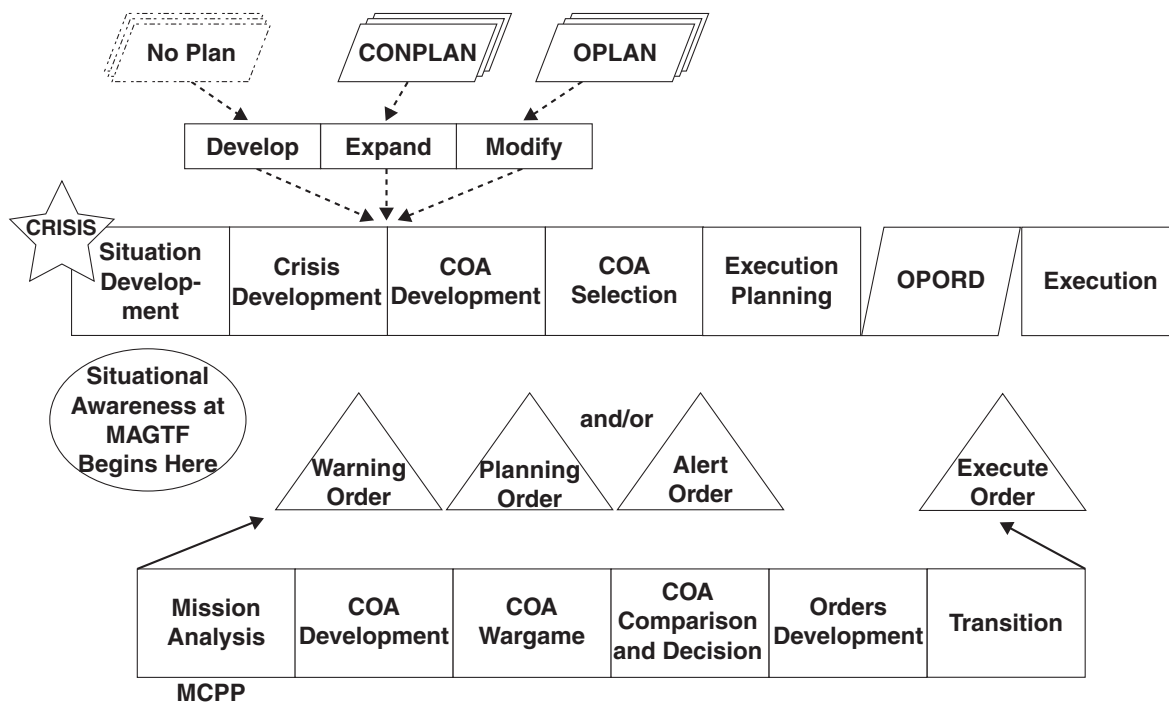

Figure 5-3. The MCPP and the Joint Deliberate Planning Process.

Planning and Imagery Intelligence

Planning and Intelligence Cycle

IMINT planning and execution is conducted concurrent with six phases of the intelligence cycle. The first phase is planning and direction. It consists of those activities that identify pertinent IRs and provides the means for satisfying those requirements. Intelligence planning and direction is a continuous function and a command responsibility. The commander directs the intelligence effort; the intelligence officer manages this effort for the commander based on the intent, designation of commander's critical information requirements (CCIR), and specific guidance provided during the planning process. Planning and direction functions include:

- Requirements development.
- Requirements management.
- Collection management.
- Production management.
- Dissemination management.
- Planning the intelligence support system.

The intelligence cycle is a procedural framework for the development of mission-focused intelligence support. It is not an end, nor should it be viewed as a rigid set of procedures carried out in an identical manner on all occasions. The intelligence cycle must be applied in a manner that develops the required intelligence in the most effective way.

The application of the intelligence cycle will vary during mission planning and execution. Application of the intelligence cycle is driven by IRs. In theory, a unique iteration of the intelligence cycle is carried out for each individual IR. In practice,

particularly during planning, IRs are grouped together and satisfied through a single, intelligence development process that concurrently addresses all IRs, including IMINT requirements. During planning, the application of the intelligence cycle supports mission analysis, course of action development and course of action wargame by providing basic intelligence, including IMINT, in the form intelligence estimates, supporting studies, and IPB analysis that describe the battlespace and threat. During course of action comparison and analysis, orders development and transition, the intelligence cycle is applied to satisfy emerging IRs and update the intelligence estimate and IPB products, all of which may be supported by IMINT. During execution the intelligence cycle is applied to implement the intelligence collection, production, and dissemination plan; refine IPB analysis, and generate mission-specific multi-discipline intelligence operations and intelligence products (including IMINT), all of which are integrated with the concept of operations. During execution, IRs are satisfied on a more individualized basis. New IRs are usually generated in response to a specific operational need. Each IR is unique and must be satisfied in a timely manner to facilitate rapid decisionmaking and the generation or maintenance of tempo (see figure 5-4).

Basic IMINT Planning Process

There are eight steps in the basic IMINT planning and execution process.

- **Planning.** The first step to receiving IMINT support is to determine that an IR exists. Exact needs are carefully determined—to include key collection, production, and dissemination requirements—so priorities can be accurately determined, resources are not overwhelmed, and timely support is received.

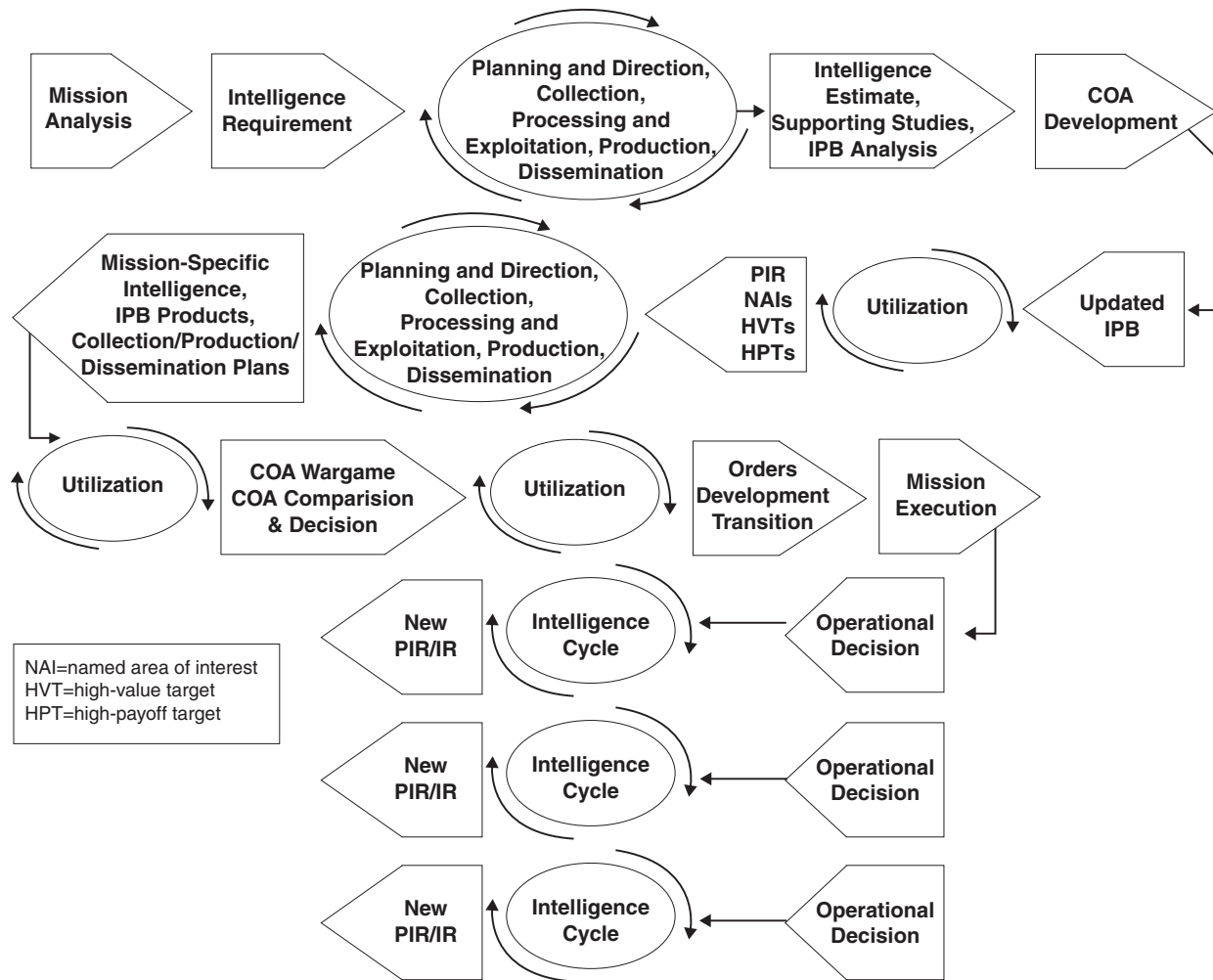

Figure 5-4. Application of the Intelligence Cycle.

- **Requesting.** The most important first step of any request is to clearly articulate IRs (to include desired imagery and other specific IMINT support). Statement of an IR should include the mission and how the intelligence product sought will get the job done.
- **Validating.** On-hand intelligence and imagery is reviewed to determine if the IR can be immediately answered. If not, it is then checked against previously validated IRs and ongoing/planned intelligence operations to avoid unnecessary duplication. Finally, it will be checked against the capabilities of the unit's

and supporting intelligence assets. If then validated, a priority will be assigned to it and associated ICRs, IPRs, and IDRs developed and prioritized.

- **Plans and Taskings.** A determination will also be made as to whether organic or external intelligence operations will be tasked to satisfy the IR. If collection is required, CMDO will determine the best intelligence asset suited to perform the mission. Concurrently, CMDO will develop plans and taskings to ensure eventual dissemination requirements can be achieved, while the P&A cell OIC will develop necessary

production plans and tasking. If organic intelligence resources will be used, appropriate orders are issued. If external support will be required, the IR will be submitted to higher headquarters or supporting organizations.

- **Collecting.** The validated ICRs and IPRs will be used to ensure the most effective type of imagery is collected to satisfy the overall IRs. The image can be recorded hardcopy or softcopy single frame or continuous (video), depending on the actual sensor. Capabilities and limitations of each imagery collection element (e.g., maximum and optimal ranges), the time the collection must occur, and the weather will influence the nature of collection operations.
- **Exploiting.** For IMINT exploitation, requirements are defined in terms of three phases of analysis, production, and reporting. Each phase represents a greater degree of analysis and a longer period of time available to accomplish the exploitation and production.
 - Phase One is the rapid exploitation of newly acquired imagery and reporting of imagery-derived intelligence and intelligence information within a specified time from receipt of imagery. This phase satisfies priority requirements of immediate need and/or identifies changes or activity of immediate significance.
 - Phase Two is the detailed exploitation of newly acquired imagery and the reporting of imagery-derived intelligence and intelligence information within the bounds of analytic requirements and timeliness of need. This phase provides an organized and comprehensive account of the intelligence or intelligence information extracted from newly acquired imagery and supported by other intelligence source materials as appropriate.
 - Phase Three is the indepth analysis of available imagery pertinent to an IR and the reporting of results within a specified time. This phase provides the most comprehensive, indepth analysis of a target

or topic in response to IRs, using imagery as the primary data source but incorporating data and intelligence from other sources as appropriate.

- **Disseminating.** Imagery and IMINT products are disseminated either as hardcopy or softcopy (e.g., digital or electronic) products. Hardcopy products will go via couriers or some type of mail system. Softcopy products may also be distributed as hardcopy products (e.g., on CDs and floppy/zip disks) or electronically via the MAGTF TDN. The requestor and the supporting intelligence officers, with assistance from units' G-6/S-6s, must ensure that the requested product can be transmitted over available supporting CIS. The length of time required to receive a product electronically depends on the size of the file. Low rates of compression (e.g., 4 to 1) allow an image to be transmitted, decompressed, recompressed, and retransmitted. Higher rates of compression generally will not allow a product to be recompressed. It is recommended that if a product will be retransmitted, a copy be made before it is compressed. Once it is determined that a product meets the need of the command, the compressed copy can be transmitted without losing data.
- **Use.** The last step of the IMINT planning and execution process, as with the intelligence process, is the most important—effective utilization. Commanders and other imagery/IMINT users should quickly notify the intelligence officer as to how well the products answered their CCIRs and IRs. Additionally, new IRs that result from the new imagery/IMINT should be rapidly identified and action initiated to most effectively plan future operations. Finally, providing the intelligence officer and IMINT elements feedback will identify problems (e.g., product formats, missing or excessive information, etc.) and allow improvements to be quickly developed and implemented.

Planning Responsibilities

Intelligence Officer

Primary staff responsibility for IMINT operations planning lies with the G-2/S-2. Specific responsibilities are—

- Preparation of integrated, multi-discipline intelligence and reconnaissance operations and supporting IMINT plans, orders, annexes, and appendices.
- Coordination with the G-3/S-3 to ensure that the planned IMINT effort supports the concept of operations and scheme of maneuver, and ensures effective prioritization and integration of IMINT operations.
- Coordination with the G-6/S-6 officer for CIS support to the IMINT elements, including circuits, network access, frequency assignment, equipment, and call signs.
- Liaison with IMINT agencies and units external to the MAGTF.
- Coordination with the G-4/S-4 to ensure adequate logistics support of IMINT elements (in particular, the transportation and maintenance of IMINT units' unique and sizable equipment).

Intelligence Battalion Commander/Detachment OIC

The intel bn commander/detachment OIC is responsible to the G-2/S-2 (or the MAGTF intelligence operations officer) for the planning, direction, and execution of MAGTF IMINT operations. Specific duties include:

- Advise the G-2/S-2 on IMINT employment and its integration with other services, JTF, theater, and national IMINT operations.
- Prepare MAGTF IMINT plans and orders in conjunction with other intelligence section staff officers and key intel bn subordinates (e.g., IIP platoon commander).

- Plan, supervise, and assist IMINT collection requirements and taskings for MAGTF operations in conjunction with the collection management officer.
- Coordinate the movement, operation, and reporting of IMINT units in coordination with the SARC OIC and the G-3/S-3.
- Coordinate MAGTF all-source fusion center (AFC) analyst exchanges with IMINT analysts, and the integration of imagery and IMINT products with all-source intelligence production in conjunction with MAGTF AFC OIC.
- Plan for the timely reporting of IMINT-derived intelligence to MAGTF and external elements and the rapid handling of perishable IMINT information in coordination with the dissemination officer.
- Plan and coordinate IMINT communications paths and information systems management and operations in conjunction with the G-6/S-6.

General Planning Considerations

Principles

Provide Imagery and IMINT to Meet Requirements

The IMINT plan must ensure imagery data is collected, processed, and reported to satisfy the IRs set forth in the commander's guidance and collection plan. Particular attention must be paid to the timeliness and formats of the data provided.

IMINT Operations Must be Integrated with Operations

The IMINT plan must take into account the location and activities of the supported units. Planned missions must be scheduled where and when they can best collect sensor data, and C2 and CIS arrangements coordinated ensuring imagery data and IMINT reports are reported to the supported units. Enemy activity may be anticipated at certain

phases of the operation; IMINT operations and analytical personnel must have a situational awareness of both intelligence estimates and ongoing operations to focus their efforts at a particular time and area. Finally, the requirement for timeliness in processing and reporting may vary depending upon the stage of the operation; personnel must be aware of current timeliness requirements as well as the availability of CIS resources with all supported commands.

Provide Redundancy in the Intelligence Plan

The IMINT plan must be integrated with other intelligence and reconnaissance operations to ensure that the needed data can still be acquired even if a planned imagery mission is canceled or if equipment malfunctions occur. The ability to provide this redundancy is dependent upon a number of factors, primarily the number of imagery missions available, capability of other intelligence resources to acquire the information needed, and the availability of production resources.

Make Full Use of All IMINT Resources

While some imagery collection resources may be held in reserve, most such units and systems can fulfill multiple missions and thus will likely be employed (e.g., ATARS). Close coordination and integration of operations and intelligence activities will aid with identifying and prioritizing such multi-purpose missions. IMINT production resources are not held in reserve.

Concept of Operations

The IMINT effort must support and adapt to the MAGTF commander's intent, concepts of intelligence and operations, and the supporting scheme of maneuver. Key questions to answer include:

- What is the MAGTF AO and the area of interest (AOD)?
- What is the MAGTF concept of operations, task organization, and main and supporting efforts?
- What are the standing PIR and IRs? Which have been tasked to supporting IMINT units? What specific information is the commander most interested (e.g., enemy ground operations, enemy air operations, target BDA, friendly force protection or enemy future intentions)?
- What is the concept of MAGTF fires support? How will MAGTF target development and target intelligence be conducted? What are the specific imagery needs in support of these?
- What are the IMINT and intelligence concepts of operations of other JTF, component, and theater resources? What is the task-organization and command/support relationships for all MAGTF intelligence and reconnaissance units?
- How can Navy IMINT assets and other Services, JTF, theater, and national IMINT assets be employed and integrated to support MAGTF operations?

Terrain

Terrain factors have a significant impact on IMINT operations; such as the ability of IMINT sensors to see through vegetation and IMINT's requirements for line-of-sight (LOS) communications. All IMINT collection systems require LOS with the target area to be effective. Accordingly, IMINT planners must assess the effects of mountains, defilade, vegetation, and other potential terrain obstacles on planned IMINT operations.

Weather

Weather is a key limiting factor for IMINT operations. Bad weather degrades the identification and location of targets. Weather can also limit the type of imagery collection capabilities that may be employed. Finally, low ceilings and poor visibility decreases visual reconnaissance effectiveness as well as the resolution of photographic systems.

Precipitation

Visible moisture degrades optical and visual reconnaissance systems. A UAV is not an all-weather

aircraft. Exposure to rain, ice, and snow can severely damage or destroy a UAV.

Wind

UAVs, due to their lighter weight, are significantly more affected by wind than manned aircraft. The Pioneer UAV has a crosswind limitation of 16 knots for takeoff and landing and a total wind component limitation of 30 knots in flight. The UAV currently under development will have a crosswind limitation of 25 knots and a total wind component limitation of 30 knots in flight.

Clouds, Haze, and Smoke

In addition to affecting an aircrew's ability to conduct visual reconnaissance, these conditions also affect EO and infrared systems in manned aircraft and UAVs.

Daylight, Sun Angles, and Shadows

The angle of the sun affects visual, TV, and FLIR observation in varying degrees. The quality of FLIR imaging decreases as the sun rises and reaches a point where a target can be seen visually. At this point the target cannot be detected by a FLIR. Prior to sunset and just after sunrise, long shadows are cast by large terrain features and can obscure objects in their path. The ideal time to take photographs or observe a target is midmorning or midafternoon. During these periods, shadows are cast long enough to add definition and dimension to a target.

Threat

General

Detailed threat analysis must be conducted to determine which IMINT sensors and platforms can be employed effectively against a given enemy and how to employ limited MAGTF and external resources to obtain the best possible IMINT. Imagery operations can be hampered by the enemy's air defense capability and its camouflage, cover, concealment, and deception activities.

Aviation-Related

Enemy air defenses have a direct effect on aerial imagery collection missions. Significant antiaircraft artillery (AAA) and surface-to-air missile (SAM) threats may degrade visual reconnaissance due to a need for aircraft to stay beyond threat air defense ranges. IMINT planners must assess threat air defense and air-to-air threats when evaluating risk and determining routes. Because of a UAV's slow speed, AAA is its greatest threat, while SAMs pose greater risks to MAGTF fixed-wing aircraft. Finally, threat electronic warfare capabilities must be determined to assess their effects on UAV and manned imagery platforms radio uplinks and imagery downlinks.

Specific Planning Considerations and Execution Activities

Planning and Direction

Objectives

IMINT planning is a continuous function that requires close interaction between the G-2/S-2 and IMINT unit planners. Key objectives include:

- Identify IMINT requirements.
- Prepare IMINT operations plan.
- Plan and establish the IMINT support system (CIS, logistics, etc.).
- Issue orders/tasking to IMINT units.
- Supervise and coordinate IMINT operations.

Key Considerations

Effective IMINT planning and execution require close coordination, liaison, and integration with all-source intelligence elements. IMINT collection management often will be driven by tip-offs (or cueing) from SIGINT, HUMINT, and other sources of intelligence. Also, fusion of IMINT with other intelligence ultimately drives the conduct of future IMINT operations and the development of IMINT products. Related concerns include:

- **Split-basing.** IMINT operations favorably lend themselves to using a split-basing concept of operations and should be considered for many deployment situations. CIS connectivity, bandwidth availability, and equipment and combat service support requirements are key factors in determining the IMINT concept of operations that must be considered.
- **Liaison elements.** Identifying, preparing, and locating IMINT or all-source intelligence liaison elements to support MAGTF IMINT operations is a critical early planning action. IMINT liaison teams will be small in number due to limited availability of imagery personnel. Placing IMINT liaison elements where they can coordinate operational planning and providing them necessary CIS support are the keys (e.g., IMINT liaisons with JTF collection and ATO planners).
- **Physical demands.** IMINT planners must take into account the strenuous mental and physical demands (especially visual) on imagery analysts during sustained operations, particularly when planning watch schedules for imagery analysts performing detailed imagery exploitation tasks. Additional IMINT planning considerations for specific type MAGTF operations include:
 - **Expeditionary operations.** Multispectral imagery, hyperspectral imagery, and other new special imagery capabilities can provide unique support to ship-to-objective maneuver (STOM) operations, such as in the detection of sandbars and obstacles in the water.
 - **Peacekeeping and humanitarian assistance operations.** National imagery usually provides the initial baseline to support planning for peacekeeping and humanitarian assistance operations. The typical multinational nature of these operations, however, leads to critical planning and dissemination requirements. National imagery is not releasable to most multi-national partners without prior approval from NIMA. Each type imagery

has specific requirements (e.g., waivers are often given for EO imagery dissemination).

Collection

A variety of organic imagery collection capabilities is available to a MAGTF (see figure 5-5). The following planning considerations are critical to effective direction and employment of these resources.

General Imagery Collection Planning Considerations

Imagery collection resources have excellent capabilities to locate and identify major threat forces, moving vehicles, weapons systems, structures and other topographic features contrasting with their surroundings. Conversely, it can be difficult to locate small, stationary and/or well-camouflaged enemy forces blending in with their surroundings. Generally it is better to employ imagery collection resources against point targets, vice in a wide area search mode. Effective integration with other intelligence operations can cue imagery collectors against key targets, reducing the general search area and more rapidly producing useful intelligence. Some basic imagery collection planning considerations follow.

Area Reconnaissance Imagery Collection. Area reconnaissance is the systematic and complete coverage of an area using visual and/or imaging means. Area reconnaissance is normally conducted for locating and identifying potential targets for further analysis or in support of terrain analysis. Area reconnaissance imagery is accomplished in one of two ways:

- By imaging back and forth across a predetermined area in such a way that the flight lines and individual images overlap. This provides complete stereographic coverage of all objects within the area at the expense of increased sensor utilization time.
- By adjusting focal lengths and/or altitudes to allow a lesser number of images to cover the target area. This reduces TOT as well as the

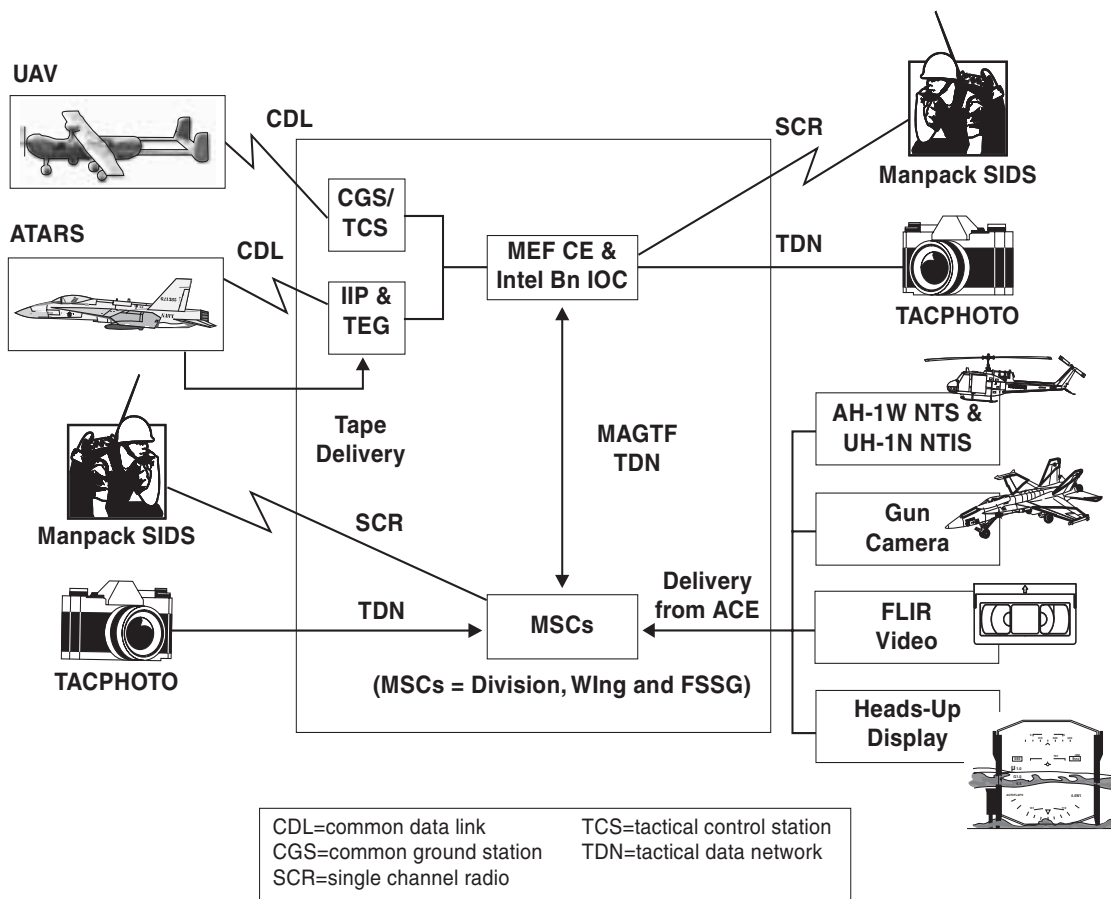

Figure 5-5. MEF Imagery Collection Capabilities.

processing, exploitation, and dissemination time at the expense of reduced resolution.

Types of area reconnaissance imagery missions include:

- BAC and BAS are area reconnaissance imagery collection tactics that are good for providing an overview of an entire area. During the early phases of an operation, these may be done for two intelligence purposes: providing a basis for the procurement of larger scale imagery of selected areas for subsequent detailed analysis; or to serve as a comparative baseline for determining the nature and extent of changes identified on subsequent missions. BAC and BAS should not be used to hunt for OOB information, as exploitation

of these is very manpower and time intensive. During such area collection operations, the flight tracks (or routes) are planned and the image exposures adjusted so that each successive image will overlap the previous one.

- DSA missions provide focus and detail and are useful for OOB confirmation counts.

Point Reconnaissance Imagery Targets. Point reconnaissance imagery target (also called pin-point reconnaissance) is a small area. While sizes may vary, at the tactical levels (e.g., MSE and below command echelons) this area is usually not larger than one kilometer by one kilometer, while at the MAGTF CE/operational level this area will generally be of 10 nautical

miles or less. Point reconnaissance missions are normally tasked to provide the highest resolution possible of a specific target to allow for detailed analysis. A command post, bridge, airfield or SAM site would be considered point targets.

Route Reconnaissance Imagery. Route reconnaissance imagery is simply imaging along specific transportation routes such as roads, railroads or waterways. This type of reconnaissance is normally conducted to determine enemy movement, to determine usability of the route, or in support of GEOINT mapping or terrain analysis requirements. This tactic is good for LOC and maneuverability studies, but generally requires significant time for effective exploitation. Route reconnaissance imagery missions should be done as a contingency baseline, ahead of time. This coverage is typically done by one or two collectors flying at a low altitude along a specified route.

Strip Search Reconnaissance Imagery. Strip search reconnaissance missions are similar to the route reconnaissance except that the collector will fly in a straight line from one point to another or along predetermined flight paths not necessarily related to transportation routes. This type of mission is frequently conducted using oblique or side-looking sensors to monitor activity across enemy lines or demilitarized zones, while allowing the aircraft to fly over friendly territory.

Aerial imagery collectors provide the flexibility to respond rapidly to changing battlespace conditions. UAVs offer the added advantage of operating in areas of heavier enemy air defenses and providing the needed intelligence without the risk of exposure of manned aircraft. Using the results of IPB and the MAGTF's concept of operations

and scheme of maneuver, intelligence imagery collection planners will generally establish detailed preplanned imagery collection routes, areas, and point targets encompassing the AOI to streamline intelligence and operational planning.

In addition to the intelligence planning considerations, such missions require detailed operational planning, particularly regarding their integration with other ACE operations. As all aerial imagery collection platforms are multipurpose, close coordination between MAGTF CE imagery planners and ACE operational planners is necessary to identify, reconcile, prioritize, and integrate competing requirements for these resources. Additionally, all aerial imagery missions must be included on the ATO and coordinated with other air operations and, where pertinent, supporting arms. This is particularly critical regarding UAV operations. UAVs enter the airspace control system via the appropriate airspace control agency, normally the direct air support center (DASC). UAV controllers maintain communications with the appropriate ACE C2 agency (e.g., the DASC) during missions to receive routing, altitude, and other pertinent airspace control information.

The commander who directly tasks or controls an imagery collection mission will receive the most responsive support. The responsiveness of the mission to other commanders depends on the number of echelons through which the mission request and resulting intelligence must flow. Accordingly, when planning imagery collection operations, the advantages and disadvantages of dedicating missions to a single command (i.e., direct support) must be assessed against the MAGTF's total IRs and the current situation.

Previously acquired imagery and IMINT products should always be reviewed to see if they can satisfy IRs without need of additional imagery collection missions.

Often the intelligence acquired from an imagery collection mission (vice the actual image itself) will be all that is required to satisfy many IRs. Likewise, dissemination challenges are generally simpler and faster when users' IRs can be satisfied without the images. Accordingly, commanders must understand the pros and cons of various imagery-related IRs to ensure optimum support.

Usually collected imagery will require additional processing and fusing with other intelligence to provide the necessary support. Depending on the situation, this may be a time-intensive task. Commanders should assess likely processing and production times and other requirements when developing IMINT plans.

Intelligence acquired from a number of imagery collectors may be disseminated directly to users with minimal additional intelligence processing and all-source intelligence analysis. Supporting dissemination plans must ensure identification of the type products likely disseminated and, the technical requirements associated with these. In the case of resources such as the UAV or JSTARS, dissemination planning includes the establishment of dedicated communications links directly between the collector and the supported unit (e.g., by assigning a UAV RRS detachment with organic communications to the supported unit's command echelon).

Types of Imagery

Vertical Imagery. Vertical imagery coverage of a target is obtained by direct overhead photography (see figure 5-6). It provides imagery of a relatively constant scale. It also allows the imagery analyst to achieve optimum results from stereovision and to accomplish the most accurate measurements. Stereovision is the effect obtained when overlapping photographs are viewed with the aid of special optical equipment, enabling height and slope determinations, as well as other detail not visible to the naked eye. Figure 5-7, on page 5-14, is an example of a vertical image.

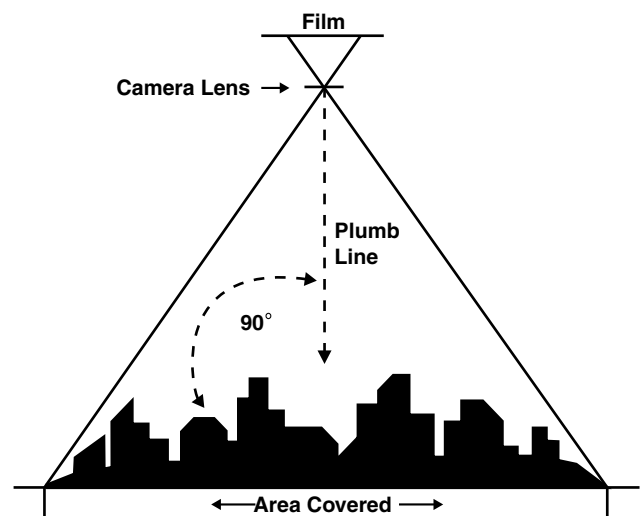

Figure 5-6. Vertical Imagery.



Figure 5-7. Vertical Imagery Example.

Oblique Imagery. Oblique imagery coverage is obtained by imagery taken at an angle from the vertical. High oblique imagery includes the horizon and has a large ground coverage (see figure 5-8); low oblique imagery does not include

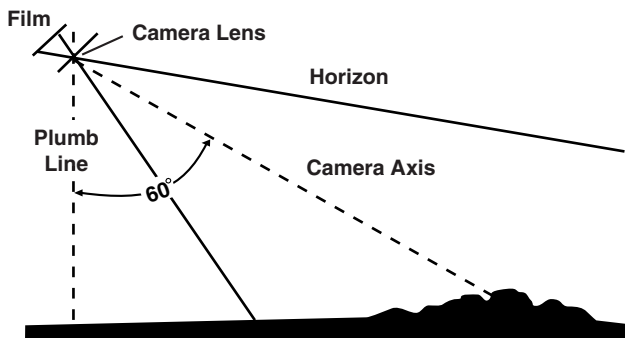

Figure 5-8. High Oblique Imagery.

the horizon and has a small ground coverage (see figure 5-9). Oblique imagery provides a representation of the target comparable to flying towards or parallel to it. It closely resembles a normal eye view and allows the imagery analyst to see into an area in a normal fashion. Measurements of oblique imagery are more difficult than with vertical imagery since the scale is not constant across the image, and precise subject distances cannot be determined. An operational advantage to such imagery, however, is the possible increased survivability it offers to manned and unmanned aircraft.

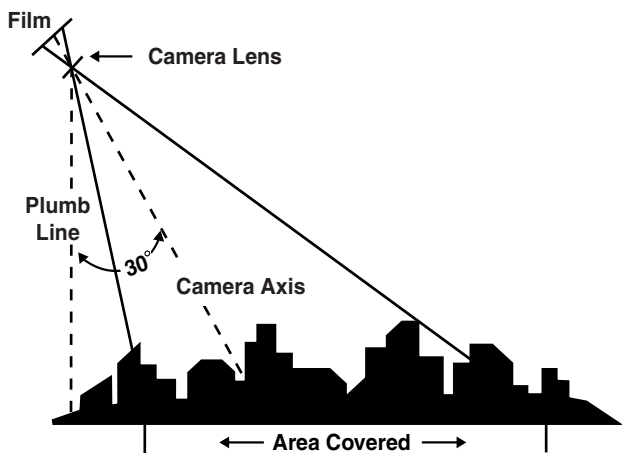

Figure 5-9. Low Oblique Imagery.

Panoramic Imagery. Panoramic imagery scans a wide area. Generally it is categorized according to the altitude at which the mission is flown and the angle of the scan. Low panoramic imagery is taken at low altitudes and scans a wide area, including the horizon on either side of the collector's flight line (see figure 5-10). High panoramic imagery is taken from higher altitudes with a smaller scan angle; generally the horizon is not visible on the image (see figures 5-11 and 5-12). This type of imagery can be useful when only one collection pass over the target area is possible as it provides coverage of

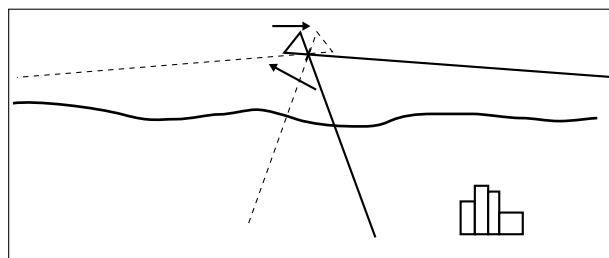

Figure 5-10. Low Panoramic Imagery.

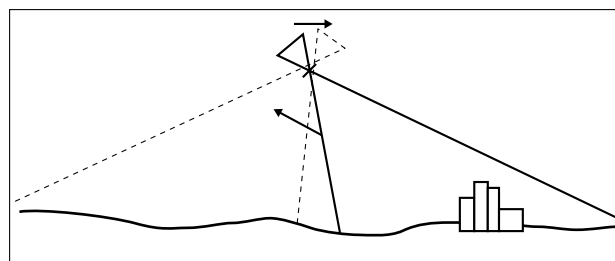

Figure 5-11. High Panoramic Imagery.



Figure 5-12. Panoramic Imagery Example.

large areas on both sides of the flight path. It is, however, more difficult and time-consuming to analyze and measure owing to the distortion of the recorded image.

Infrared Imagery. Infrared imagery is the remote sensing of a target's radiant temperatures. The system is used to measure the temperature differences between terrain features and surrounding objects on the ground, producing a near-optical quality infrared image (see figure 5-13).



Figure 5-13. Infrared Imagery Example.

These systems can operate during either day or night and under all weather conditions. However, they are less effective during day/night transition periods or when backgrounds and targets have the least difference in temperature. Also, infrared imagery uses temperature differential to generate the image so anything that degrades infrared transmission will impact the imagery.

Infrared imagery complements photographic imagery by day, and they are commonly used together. Unique infrared imagery capabilities include imaging the shadow on a heat-absorbing surface or the thermal scar of a heat-generating object (e.g., aircraft after it has moved).

Radar Imagery. As a radar can penetrate virtually all atmospheric conditions, radar imagery generally is limited only by the capability of the

platforms conducting the collection mission. Radar operates on two principles: all materials reflect a portion of electromagnetic radiation; and electromagnetic energy is directed in a beam from the antenna to the target area. It is then reflected by the target back to the collecting platform. Variations in pattern and tone of the returned pulses are recorded and displayed as radar images. Figure 5-14 is an example of JSTARS SAR imagery. The geometry and surface composition of targets and their surroundings can greatly affect the intensity of the radar pulse return. To detect moving targets, radars employ the principle of doppler shift. Doppler shift is the result of a moving object causing a subtle change in the frequency of the reflected pulse energy. This change is detected by comparing the original pulse energy frequency to the frequency of the reflected energy. Advantages of radar imagery include its superb capabilities over great distances under a wide variety of conditions; it provides great operational flexibility, particularly during mid to higher intensity combat

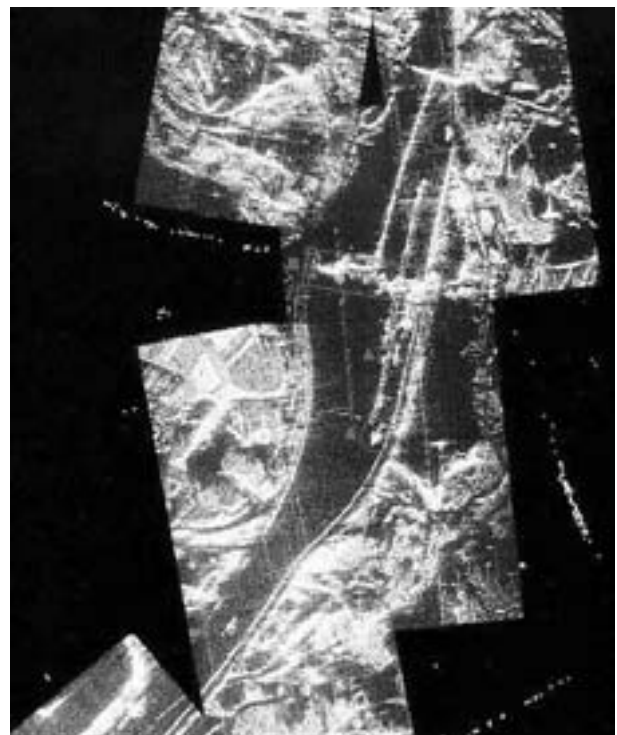

Figure 5-14. JSTARS Synthetic Aperture Radar Imagery Example.

operations; and it provides constant scale. However, radar imagery is not useful as a stand-alone intelligence product. Unlike optical imagery, it presents an abnormal view of the battlespace, requiring special skills and time to analyze properly. (See figure 5-15 for an example of an MTI image.)

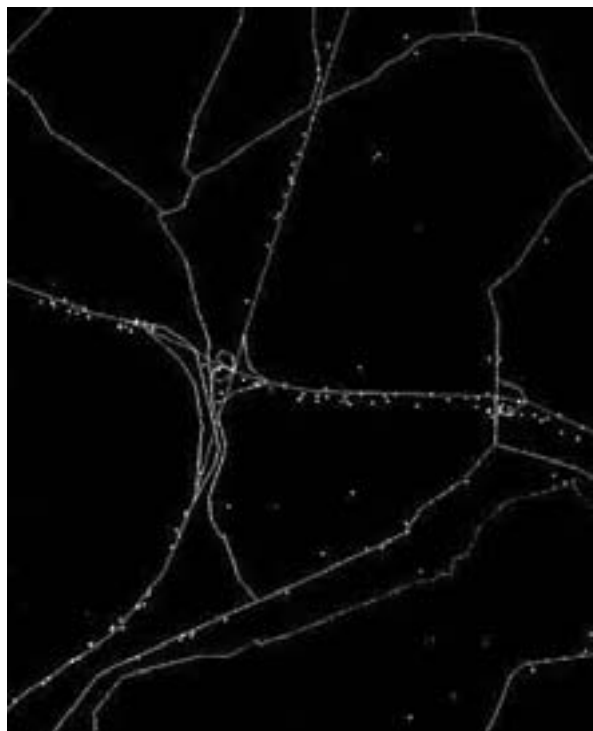

Figure 5-15. JSTARS Moving Target Indicator Imagery Example.

Electroptical Imagery. EO imagery employs digital imaging techniques to extend and complement other imagery. Advantages include the dynamic range of the sensor generally is greater than other types of imagery; it can penetrate atmospheric conditions that are opaque to other sensors; and, like radar imagery, EO imagery is readily exploitable by automated processors and analytical aids. EO uses the visual spectrum, so anything that impacts this (dust, smoke, haze, clouds, rain, fog, light level, angle of illumination, etc.) will affect the quality of the imagery.

Multispectral Imagery. Multispectral imagery (MSI) records views in a number of spectral bands or frequencies simultaneously, providing a wider

range of processing and analytical techniques to be employed. The key to interpretation lies in identifying the spectral signatures of different surfaces and targets. Every surface or target gives off its own distinctive pattern of radiation, whether it is generated by itself or reflected. This will depend on its reflective qualities, its heat, whether it is a solid or liquid, how smooth its surface is, and many other factors. MSI usually has less resolution in the visible spectrum but can reveal details not apparent on the latter. This allows MSI the capability of providing map-like products to support area familiarization and orientation. Unlike other types of imagery, most MSI products are acquired from commercial sources. NIMA is responsible for purchasing, archiving, and disseminating MSI products for DOD.

Commercial Imagery. The commercial imagery industry is planning the launch of several new high resolution visible, MSI, and other imagery systems within the next 5 years. These systems will provide an increased capability to supplement and complement our national imagery technical collection. HQMC Imagery and Geospatial Plans and Policy works closely with NIMA on numerous commercial imagery issues. Marine Corps policies and procedures for requesting, tracking, obtaining, and purchasing commercial imagery are being developed and will be promulgated once NIMA's Commercial Imagery Management Office (CIMO) develops a commercial imagery plan to provide better DOD and intelligence community access to commercial imagery.

Domestic Imagery Collection. Domestic imagery collection is satellite and aerial imagery of any part of the US, its territories or its possessions, including the 12 nautical miles seaward of these land areas. A Proper Use Statement and approval are required before domestic imagery collection may be conducted. Central to this process is a thorough review of planned missions to ensure that the constitutional rights of US persons are protected in accordance with current laws and executive orders that restrict intelligence activities directed against US persons within the US. Once approval has been

obtained, proper use statements must be retained in the permanent files of the requesting unit and higher headquarters up through the combatant command headquarters. (See the NIMA Imagery Policy Series [section 9, part B], *Domestic Imagery* [IPS-001/98-S9A] for additional information on domestic imagery collection.) Request channels for domestic imagery collection are:

- **Marine Corps specific requirements.** Proper use statements are submitted via the service chain of command to HQMC Imagery and Geospatial Plans and Policy.
- **Joint operations requirements.** Proper use statements are submitted via the operational chain of command to combatant commander for adjudication or follow-on action as appropriate.

Aerial Imagery Collection Missions

Preplanned Missions. Preplanned aerial imagery missions (UAVs, ATARS, JSTARS) are requested using the joint tactical air reconnaissance/surveillance request (JTAR/SR) format (see appendix C, section I). Within the MAGTF, preplanned aerial imagery requests are routed through the intelligence chain and consolidated by the MAGTF CE's intelligence section for validation, prioritization, and follow-on planning and coordination. Once a decision is made to conduct an aerial imagery collection mission, the G-2/S-2 concurrently will: refine the JTAR/SR as required and submit it to the G-3/S-3 for follow-on planning and integration within the MAGTF and/or JTF ATO; and, plan and coordinate supporting intelligence production and dissemination plans. Key planning information included on JTAR/SRs are—

- Date-time factors: dates and time on targets desired and latest time desired intelligence will be of value (LTIOV).
- Type intelligence collection mission. (It is emphasized that the same request and planning process is used not only for aerial imagery collection missions, but also for aerial electronic intelligence/electronic warfare support missions and aerial visual reconnaissance missions.)

- Target, route or area coordinates.
- Target categories and associated PIR.
- Type intelligence products desired (i.e., reports and photos or reports only).
- Units to whom the resulting intelligence products will be disseminated.

The long lead time required for JTAR/SR submission needed by ACE operations planners is not often conducive to effective intelligence and IMINT planning. Therefore, effective standing operating procedures (SOPs) must be developed between G-2/S-2 and ATO planners to both meet air operations deadlines and strive to accommodate the intelligence planning aspects of rapidly changing situations. One method that may be used by intelligence planners is to initially provide ATO planners the most comprehensive JTAR/S request possible (i.e., specify desired aerial imagery platforms, type of imagery mission, targets, and anticipated IRs). At a designated time (i.e., no later than 6 hours prior to mission start), imagery planners will provide ATO and imagery collection units with the final detailed intelligence tasking information for each mission-detailed target point/route/area location information, specific IRs, and final C2, reporting criteria and CIS channels to be used.

Immediate Missions. Immediate requests for aerial imagery collection may be submitted directly to the DASC. However, as available resources are generally limited and operating in general support of MAGTF requirements, approval from the mission's controlling intelligence officer must be obtained prior to diverting an aerial imagery platform from a preplanned mission.

The joint tactical air strike request format shown in appendix C, section II, may be used to request immediate aerial imagery collection support. If approved, the mission may be executed in one of the following ways:

- An ongoing mission can be diverted by its controlling authority to conduct the immediate mission.
- An on-call/standby mission may be allocated.

Air Planning and the Air Tasking Cycle.

Whether for preplanned or immediate air missions, the air tasking cycle is the key tool used by MAGTF planners to most effectively plan air operations to support mission accomplishment. It is an integral part of the MAGTF planning process. By using and completing the tasking cycle, planners can ensure that limited aviation assets are used to achieve their maximum effect with correct prioritization, C2 and CIS in support of the MAGTF’s main and other key efforts. The principal planning product of the air tasking cycle is the MAGTF ATO or air plan. The six phases of the ATO cycle are command aviation guidance, target/air support mission development, allocation and allotment, tasking, force execution, and combat assessment (see figure 5-16).

The ATO is a document generated by the JFACC or the ACE commander. It tasks and disseminates to JTF components, subordinate units, and C2 agencies the specific missions and targets of projected air sorties, capabilities, and forces. It normally provides both general instructions and specific instructions, including call signs, targets, and controlling agencies. The airspace control order is included in

the ATO. Special instructions, providing amplifying notes, important details, and changes are included in the ATO or issued separately. The ATO, airspace control order, and special instructions provide operational and tactical direction at appropriate levels of detail.

Each ATO covers a 24-hour period. There are usually three ATOs at any given time:

- The ATO in execution (today’s plan), monitored by the ACE current operations staff.
- The ATO in production (tomorrow’s plan).
- The ATO in planning (the following day’s plan) by the ACE future operations planners.

Because input to the joint ATO must be provided 3 to 4 days in advance, the ATO can represent only a starting point for daily MAGTF flight operations. It is impractical to predict every need in advance. The MAGTF commander must have the flexibility to launch or to divert any aircraft as necessary to complete the mission, even if this requires short-notice deviations from the ATO.

In accordance with maneuver warfare, the ATO must be flexible enough to change with the needs of the force as the situation changes. It is not a

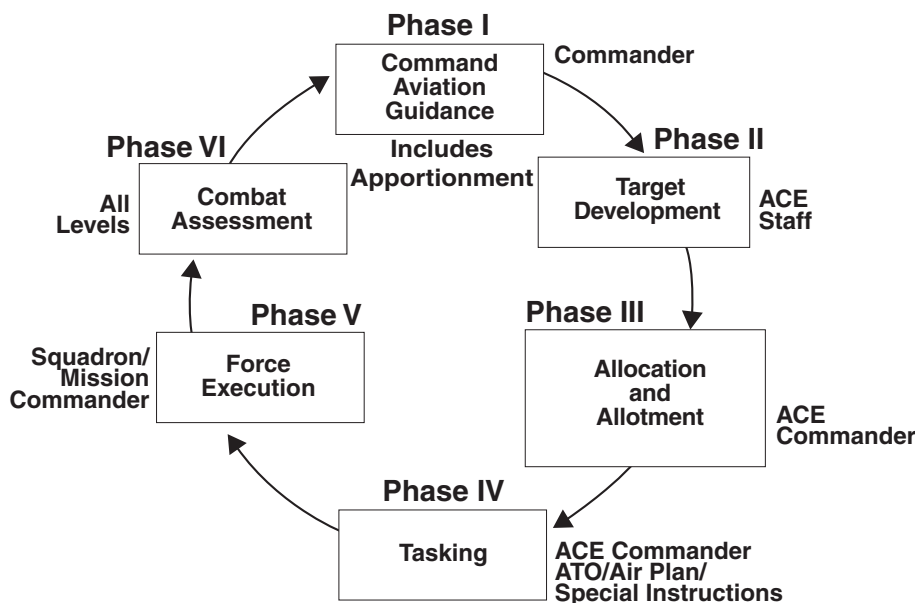

Figure 5-16. The Six-Phase Aviation Tasking Cycle.

rigid constraint on operational flexibility. Because the ATO represents a great deal of necessary coordination and deconfliction of air assets and airspace, however, necessary deviations from the ATO should be well-justified and relevant. Headquarters should be informed as quickly and as fully as possible. The process by which changes are made to the ATO is directed by the JFC.

During purely Navy/Marine Corps operations afloat, there may be no ATO as such. All squadron flight schedules are consolidated with the needs of the MAGTF/ship/amphibious ready group (ARG)/carrier battle group (CVBG) at an air board. The air board meets every day in the supporting arms coordination center (SACC). It works on current and future plans for air support. The results are published as the ship/ARG/CVBG air plan. The air board also provides the input for the joint ATO. Generally the MAGTF intelligence section will have a representative from its future plans section or intel bn's CMD section at all air board meetings to coordinate aerial imagery and other air intelligence mission needs.

Not every mission on squadron flight schedules and air plans will appear on the joint ATO. Flights that are within the MAGTF's airspace and made in support of the MAGTF; e.g., not in support of the JTF, may or may not be included in the joint ATO. Such flights are mostly helicopter flights and functional check flights. Such flights may include tactical missions generated to respond to the changing battlespace situations. Often, ships (particularly aircraft carriers) may operate outside of the JTF's airspace entirely. In such cases, missions that do not enter JTF airspace will not appear on the joint ATO. Nonetheless, every mission that is submitted and approved for the joint ATO must appear on squadron flight schedules and the MAGTF/ship/ARG/CVBG air plan.

Requesting JTF, Theater and National Imagery Support. Significant imagery and IMINT support is available to the MAGTF from external sources ranging from dissemination of

existing imagery and products through the integration of existing information into new products and execution of new imagery collection and IMINT production. MAGTF IRs that cannot be satisfied via organic resources will be submitted to the next higher command echelon for validation, prioritization and, if possible, satisfying the request for intelligence or collection requirements through its organic resources before forwarding it to the next higher command echelon. The specific IR will determine how the requirement is identified and submitted. Techniques range from use of the standard request for information format, using the RMS resources and procedures (for new imagery collection requirements) or using COLISEUM resources and procedures (for IMINT or all-source production requirements). Figure 5-17 identifies the two different tracks external imagery and IMINT requirements may take.

Processing and Exploitation

Processing and exploitation involve the conversion of collected data into information that is suitable for the production of intelligence. Processing is largely a technical function that does not add meaning to the data, but instead is necessary to convert the data into a form that commanders and planners can understand (e.g., developing a piece of film into a usable image). Some types of data require minimal processing—they may be collected in a form that is already suitable for production. Other types of data require extensive processing to incorporate amplifying data not available on the raw image products, affecting the timeliness and accuracy of the resulting information.

The degree of automated processing resident in IMINT resources varies. For example, the video downlink from a UAV can provide the geographical coordinates of acquired targets—but only to select C2 nodes. Likewise, the JSTARS CGS is capable of automatically processing, storing, and displaying acquired MTI, FTI, and SAR imagery. Usually acquired imagery requires additional processing and exploitation before it is usable. This processing and

Requesting External Imagery Collection & Production Support	
Service-Unique Environment	Joint/JTF Environment
MCIA	JIC
National Collection	National Collection
NIMA	NIMA
USMC DRO	DIA
HQMC/IPI	JTF J-2 JISE
MARFORPLANT/MARFORPAC	MARFOR G-2 or MEF IOC
MAGTF CE RFI/RMS/COLISEUM	MAGTF CE RFI/RMS/COLISEUM

Requests for national-level imagery collection and IMINT production take one of two tracks: via peacetime service-unique channels (e.g., exercises, planning); or via joint/operational channels for actual operations.

Figure 5-17. Requesting External Imagery and IMINT Support.

exploitation of imagery data into IMINT is accomplished by the IIP or MCIA imagery analysts or by CGS personnel. They refine raw imagery into clear and usable imagery products by using manipulation tools available at their workstations (e.g., annotation of images, immediate identification of key pieces of threat equipment, measurement of a structure’s dimensions). Situational factors and standing IRs will be assessed to determine to what degree such products may be immediately disseminated or whether additional intelligence analysis is required.

Production

Production is the activity that converts information into intelligence. It fuses new information and existing intelligence from all sources to provide meaningful knowledge that can be used for decisionmaking. Production involves the evaluation, interpretation, integration, analysis, and synthesis of all information that is relevant to a particular IR to answer the question(s) that have been asked.

The results of exploited and analyzed imagery and imagery data form the basis for IMINT reports and derived products provided to the G-2/

S-2 for the further production and analysis of all-source intelligence, directly to tactical commanders and to other users. User needs will rarely be fully satisfied simply via uninterpreted image prints. Instead, IMINT production planning and management will be closely coordinated with all-source intelligence production management and planning to determine the scope, content, and format for each product; to plan and schedule the development of products; to assign priorities among the various IMINT product requirements; to determine who needs what products and in what quantities; to allocate IMINT processing, exploitation, and production resources; and to coordinate production efforts with IMINT and all-source collection and dissemination activities. The goal is effective and efficient use of limited resources while ensuring that IMINT production is focused on validated PIRs and IRs and associated specified intelligence reporting criteria.

IMINT production can range from the preparation of highly sophisticated multimedia products to the selection of suitable imagery forms for either stand-alone use or for integration and fusing within all-source intelligence products.

A wide variety of IMINT products may be developed, either as stand-alone, single source products or as part of all-source intelligence products: annotated prints, mosaics, oblique panoramas, supporting detailed IMINT, and all-source intelligence text reports.

Imagery Graphic Products

Imagery graphic products of objective areas (target areas, beaches, helicopter landing zones, etc.) are useful for a variety of planning and decision-making activities. Such products include:

- **Photographic prints.** A photographic print represents a single frame of imagery from a mission. Photographs often portray an idea more rapidly and concisely than words. For this reason, prints can provide a picture of significant items of interest to users in addition to any written reports. Prints will usually be annotated in some fashion to emphasize significant military information. Minimum annotations usually will be a titling strip, to include a grid reference or geographic coordinates for the illustrated target(s) and the date-time-group of the imagery, and a north arrow or other orientation aid to help with orienting the print to a map. Other annotations may include target categories and descriptions.
- **Mosaics.** A photographic mosaic is a combination of two or more overlapping prints that form a single picture. Mosaics can be of significant value in providing an updated picture of a large area to supplement map data. Usually vertical photographs are used and produce “map-like” results, but oblique photographs may be used to produce a panorama. Mosaics supplement map data and text intelligence reports by displaying current information on roads, trails, built-up areas, and the conditions of terrain and vegetation.

IMINT Text Products

Commander’s timeliness requirements will drive the type and preparation of each of the below IMINT text products. (Appendix F provides the formats and instructions for the following IMINT reports).

- **Reconnaissance Exploitation Report (RECCEXREP).** The RECCEXREP is used to report the results from the first rapid analysis of imagery, to include the debriefing of the aircrew when possible. It addresses those targets requested in the original imagery collection mission tasking, normally with each target addressed separately. It is prepared by the IIP (with input from the supporting collecting unit’s intelligence section) and disseminated in accordance with the dissemination plan. The specified time limit in which the RECCEXREP must be completed and disseminated will be per unit SOP.
- **Initial Photographic Interpretation Report (IPIR).** The IPIR provides information on tasked imagery collection missions not previously reported (e.g., in the RECCEXREP) when extensive or detailed data from a systematic review of the imagery is required or if the rapid response required by the RECCEXREP would be hindered by the format, size or quality of the imagery involved. It also is prepared by the IIP (with input from the supporting collecting unit’s intelligence section) and disseminated in accordance with the dissemination plan. The specified time limit in which the IPIR must be completed and disseminated will be per unit SOP.
- **Supplemental Photographic Interpretation Report (SUPIR).** The SUPIR provides information not previously included in a RECCEXREP or IPIR. It reports on significant targets covered by the mission and other required supplemental data. It is prepared by the IIP (with input from the supporting collecting unit’s intelligence section) and disseminated in accordance with the dissemination plan. Generally, the unit SOP specifies the time limit for completing and disseminating the SUPIR.
- **SALUTE Report.** The standard SALUTE (size, activity, location, unit, time, equipment) report is used to report any known or suspected enemy activity. It may also report any characteristics of the area of operations that affect mission accomplishment. The SALUTE report

may be used by UAV squadron, ground reconnaissance, aircrew or other personnel to report key information obtained during ongoing imagery collection operations. It will be disseminated in accordance with the dissemination plan—generally from the collector to the SARC or directly from the collector to other supported units.

IMINT Support to Other All-Source Intelligence Products

Imagery alone will provide useful intelligence to commanders and planners. See appendix G for detailed information regarding imagery and IMINT support to IPB and other all-source intelligence products.

Usually IRs will be satisfied more effectively and in greater detail via the complementary combination of an image and supporting IMINT or all-source intelligence products. Review appendix H for an appreciation of the greater intelligence value of a complementary imagery/intelligence report product, vice simply an image product.

Photogrammetry

Photogrammetry includes the precise measurement and computation required in imagery analysis. Measurements of objects/targets as they appear on imagery can be used to compute lengths, widths, heights, and imagery scale. Depending upon the IR, the photogrammetric process can be difficult and time-consuming. Vertical images are relatively straightforward and quick to measure, but oblique and panoramic images will require greater effort, which can degrade timeliness requirements (particularly at tactical levels). Photogrammetry provides information on—

- Vehicle and equipment dimensions as an aid for identification and for technical analysis.
- Building, storage and other facilities, as well as installations' sizes and capacities.
- Bridges, roads, and other LOCs dimensions and compositions.
- Image scales.

- Speed and the direction of movement of targets and other objects.
- Targeting and weaponeering.

Target Analysis

Generally the imagery analyst's first responsibility is the detection and accurate identification of areas and activities for situation development and support to targeting.

Target detection begins with one of two search modes: general and specific. General search is undertaken in response to requests for broad area intelligence and usually involves the analytical examination of the entire image. Such searches should be kept to a minimum. Specific search is undertaken in response to an IR that requires point, strip or route reconnaissance imagery. Its scope and objectives are more limited than general search.

Target identification consists of the interpretation of visual cues or distinctive features of targets/objects detected during collection. The distinctive features are analyzed using the six Ss: size, shape, shadow, shade, surroundings, and signal strength. The depth and scope of the analysis is highly dependent upon the purpose of the analysis and the associated IR time constraints. Target identification may include:

- Determining the OOB and battle damage assessments of threat units and systems at different echelons.
- Identifying both equipment and its intended use by the threat forces.
- Determining the purpose and composition of ports, harbors, waterways, airfields, roadways, railways, and installations.
- Detecting and identifying nonthreat forces and equipment and sensitive targets (e.g., religious facilities).

See appendix I for information on target folders and IMINT support to these.

Exploitation

Satisfying many IRs will require greater imagery exploitation. Such situations include functional analysis of an object, equipment or environmental analysis; previously unknown objects, equipment or modifications, and activities; unusual concentrations of military or nonmilitary personnel or objects; etc.

National Imagery Interpretation Rating Scale

National imagery interpretation rating scale (NIIRS) is used by collection managers as an aid to the identification of the quality of imagery needed to satisfy their IRs. Additionally, imagery analysts use NIIRS to rate the quality and interpretability of acquired imagery. (See appendix B for the visible, infrared, radar, multispectral, and civil NIIRS.)

Imagery Databases

In addition to the development of these products, production also entails the indexing, maintenance, and administration of imagery and IMINT product databases as an aid to future IMINT activities. Imagery analysts must ensure that acquired imagery is incorporated into the MAGTF IPL (see figure 5-18). Generally the IPL will include images in reduced resolution format reviewed by intelligence personnel and other users throughout the MAGTF. Those full-resolution images that meet their IRs can then be downloaded and disseminated.

Dissemination and Reporting

IMINT dissemination planning and management involves establishing dissemination priorities, stipulating dissemination and reporting criteria, selecting

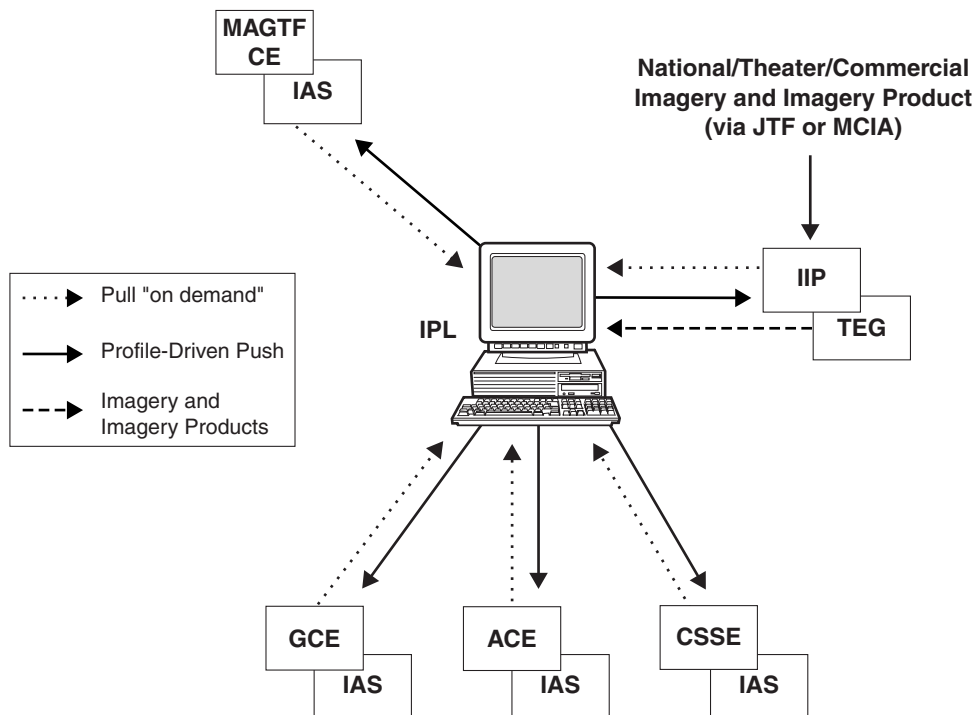

Major subordinate commands (MSCs) down to the regiment/group level will have IPLs with which to store imagery and imagery products and access the Imagery Library Network. IPLs will be populated on the basis of demand-driven "pull" and user-developed profiles ("push").

Figure 5-18. MAGTF Image Product Library.

dissemination means, and monitoring the flow of IMINT reporting. The goal is to deliver IMINT products to the appropriate user in the proper form and at the right time, while concurrently preventing the dissemination of irrelevant products and avoiding information overload. The following paragraphs address the most common considerations for intelligence dissemination planners in developing IMINT dissemination plans.

Identify Dissemination Requirements

When identifying requirements, the four Ws—the who, where, what, and when questions—are a good start for identifying the broad scope of dissemination needs.

The Whos. Commander preferences, standing theater OPLAN/concept plans (CONPLANs), type mission analyses, unit SOPs, TTPs, playbooks, and previous postexercise analyses and lesson learned reports are all key sources for identifying organizations, units, and other elements that the intelligence section must disseminate imagery and IMINT. Identifying and grouping by common imagery and IMINT product requirements by typical command relationship/task organization provide the operational perspective to begin dissemination planning.

- **Internal MEF/MAGTF Headquarters.** Current operations center, future operations center, tactical command echelon (when deployed), force fires coordination center, rear area operations center (when established), civil-military operations center (when established).
- **Subordinate Elements and Unit.** Intelligence sections of the GCE, ACE, and CSSE; other MAGTFs and independent task forces; organic/attached/direct support intelligence and reconnaissance units for whom the MEF retains operational control (via either the SARC, other G-2 sections, direct support teams, and/or direct to the intelligence/reconnaissance units' command posts); and other C2 nodes and facilities, when required (e.g., DASC, enemy prisoners of war com-

pound, rear area operations center, airfield arrival control group).

The Wheres. Usually this will correspond to the location of each identified “who.” However, command relationships, the specific operational phase, task organization or other factors may identify other answers to “where” dissemination requirements.

The Whats. With the above information in hand, dissemination planners now seek answers to the “what” of each requirement. Here planners strive to establish or anticipate what type intelligence support—finished intelligence, particular formats—each “who” typically requires to support its planning and decisionmaking needs. As with the “who” determinations, commander preferences, standing theater OPLAN/CONPLANs, type mission analyses, unit SOPs, TTPs, and playbooks, and previous post-exercise analyses and lesson learned reports all are key sources for isolating “what” needs and will provide the dissemination SOP foundation. Additionally, planners' research should encompass how differing intelligence resource task organizations affect what requirements and to how the possible “whats” historically have been combined to satisfy the “whos” requirements. Cross-referencing the “who” and “what” answers with the following groupings completes this step:

- Typical stand-alone imagery and IMINT products; and IMINT support to all-source intelligence products.
- Alarm intelligence support (e.g., I&W reports, time-sensitive target of opportunity reporting).
- Preferred level(s) of classified information that the who desires (further subdivided into what they require access to and what they can actually retain on hand).

The Whens. The final dissemination planning information requirement is to determine each “whos” typical or stated “whens”. The same sources used to research the previous Ws likewise are recommended for acquiring initial when

answers and baseline planning criteria. However, this factor is arguably the most variable during tactical operations. Key planning considerations include:

- Nature of the requirement (e.g., is it a PIR or in support of another functional information requirement).
- Rapidly assessing the feasibility of satisfying the decisionmaker's or planner's stated LTIOVs (Is intelligence already on-hand? Can organic assets acquire or produce needed intelligence? Will external support be needed?).
- Communications and networks transmission requirements for the who's desired format (voice, text, digital, bulk delivery, etc.)
- Capabilities/current status of MAGTF CIS.

Develop Dissemination Plan

The answers to the four Ws can now be translated into an IMINT dissemination plan. IMINT personnel must maintain close coordination with all G-2/S-2 officers, G-3/S-3 planners, and pertinent intelligence personnel at higher, adjacent, supporting, and subordinate organizations.

Design and Coordinate Architecture. The architecture should be designed schematically so that it depicts organizations, type intelligence systems, and CIS connectivity among the forces' (MAGTF, joint, naval) intelligence collectors/producers and the supported decisionmakers/planners. Since planned architectures must incorporate sufficient flexibility to adjust quickly to changing tactical circumstances, it must depict both primary and alternate pipeline and alarm channels and the demand-pull and supply-push methodologies.

The large data communications bandwidths associated with much imagery dissemination requires close planning and coordination between MAGTF intelligence and CIS planners (see figure 5-19). Also, see appendix J for additional technical information on national imagery transmission format

(NITF) compression that is useful when designing and coordinating CIS support to IMINT dissemination.

Establish IMINT Dissemination Procedures.

Comprehensive, MAGTF-wide integrated operations/CIS/intelligence procedures are mandatory if intelligence dissemination is to be effective. Answers to the four Ws will provide the initial foundation for development of a MEF's intelligence dissemination architecture and operations. General dissemination procedures should be established for the delivery of IMINT and imagery from the controlling producers or agencies to designated recipients. The precedence of transmission—ranging from routine to flash—should be agreed upon by all involved parties in advance. Audiences should be predetermined as well by defining broadcast parameters (e.g., general or specific). Further, irrelevant intelligence can be better eliminated if reporting regimes, thresholds, and filters are identified early.

Allocate or Obtain Resources. The intelligence officer, in concert with the unit's CIS officer and G-3/S-3, should allocate available resources to accommodate dissemination of the requested IMINT. If resources do not exist to transmit the required information, a request for augmentation from higher headquarters or assistance from lateral units should be initiated immediately. Often it may be necessary to arrange for the delivery of intelligence directly from the producer to the requester if means are in place.

Coordinate. Once IMINT requirements have been identified and the initial plans developed, planners will develop and coordinate detailed dissemination plans. Key considerations include:

- Close coordination among MAGTF CE IMINT, ACE intelligence, and imagery collection units' planners to ensure planned imagery collection missions, specific IRs, routes, and reporting criteria reflect ongoing developments.

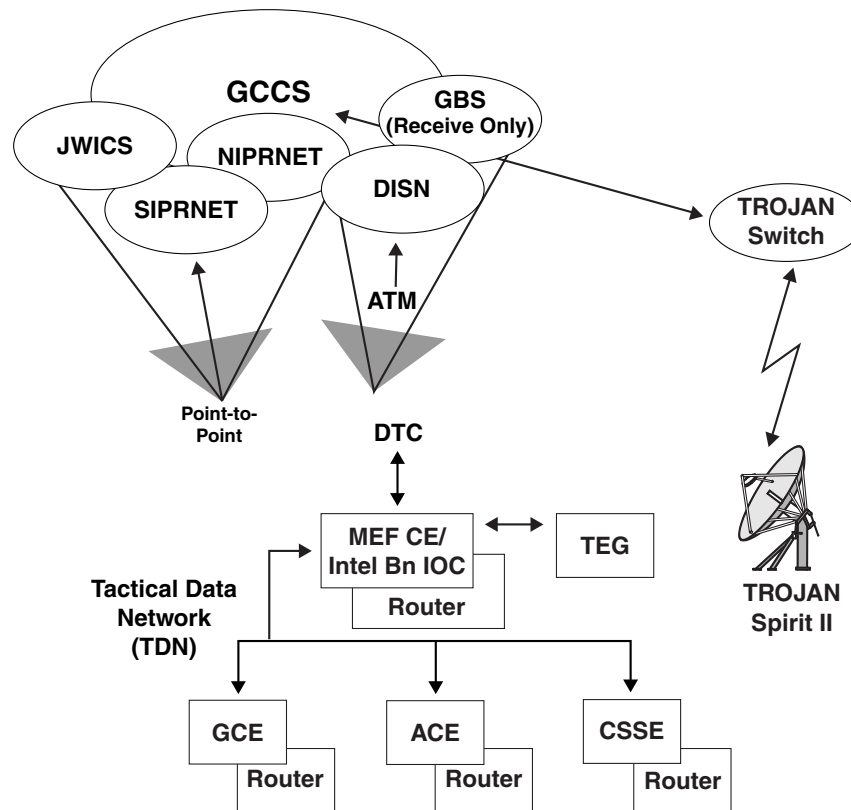

Figure 5-19. Key CIS Pathways for Imagery Dissemination.

- Close coordination between MAGTF CE IMINT planners and subordinate units' intelligence personnel to ensure that they are cognizant of planned imagery collection missions. In addition to voice and e-mail coordination, a useful technique for keeping everyone apprised of planned imagery missions is by including in MAGTF intelligence summaries a detailed paragraph describing specific planned imagery collection missions and associated priorities, collection times, targets, routes, IRs, and primary and alternate reporting channels.

Monitor Execution. Once imagery or IMINT products have begun to be disseminated to the requester, it is important to constantly evaluate the flow of information to determine if the user is satisfied with the quantity and quality of intelligence; and, to ensure that preplanned filters are eliminating

circular reporting. Frequent checks with the requester can ensure intelligence utilization and preclude unanticipated demands on the G-2/S-2 staff.

IMINT Utilization

The specific utilization of IMINT is based upon the concept of operations and the imagery application being employed. Commanders, G-2/S-2s, and G-3/S-3s must continuously evaluate IMINT products and reports for timeliness, usefulness, overall quality and responsiveness to stated PIR and IRs, and provide feedback to the MAGTF G-2/S-2 and IMINT planners to improve future IMINT operations. Ultimately, IMINT utilization will provide guidance and determine requirements to support ongoing IR management and supporting IMINT operations.

IMINT Operations Appendix

Guidance for the conduct of IMINT operations comes from many sources. DIA and NIMA issue policies, direction, guidance, and instructions on compliance with national IMINT standards, architectures, and request procedures.

Since MAGTFs will normally be part of a JTF or naval expeditionary force, reference to pertinent combatant, joint force, and fleet commanders' orders, guidance, and IMINT TTPs are necessary to identify unique operating concepts, methodologies, support procedures, and formats. Marine IMINT plans and orders are prepared by the G-2/S-2 (under the staff lead of the ISC and with the assistance of the other G-2 section and intel bn staff officers and commanders) and the COs/OICs of the supporting IMINT units. MAGTF IMINT plans and orders appear as appendix 7 to the intelligence annex of the MAGTF operation plan or order and will focus on internal MAGTF IMINT requirements, operations, and TTP.

Appendix 7 (Imagery Intelligence) to annex B (Intelligence) to an OPLAN or OPORD will provide detailed planning and direction for the conduct of MAGTF IMINT operations. The ISC is responsible for its development. It will be prepared consistent with format outlined in the JOPES, tailored as necessary consistent with the situation and the MAGTF's needs. (See appendix K for a sample IMINT operations appendix format.) The IMINT operations appendix should include friendly IMINT forces to be used, including:

- Personnel augmentation requirements.
- IMINT units of adjacent or other theater forces and support expected.
- Joint force maritime component commander (JFMCC), naval task force and/or amphibious force IMINT elements that provide support to the LF in amphibious operations.
- Pertinent IMINT capabilities and support from the JTF headquarters, combatant command's JIC/JAC, and other component commanders/task forces within JTF operations.
- Planned arrangement and employment of external IMINT support, including special collection, production, dissemination, and CIS.
- Establishment of coordinating instructions for the planning and control of IMINT operations to include the technical support expected from higher headquarters.
- Tasking of MAGTF IMINT elements.
- IMINT production, priorities, and plans.
- IMINT dissemination priorities and plans, to include CIS support to the MAGTF IMINT effort.
- IMINT unique equipment/logistics requirements.

IMINT Plans within Other Portions of Annex B

In addition to appendix 7, there are other portions of annex B that IMINT provides critical contributions or that provide critical operational and intelligence integration plans pertinent to IMINT operations.

Appendix 11 (Intelligence Estimate)

Once a basic understanding of the mission, AO, threat and other pertinent matters is known, it is necessary to view the situation through the adversary's eyes and provide this intelligence assessment to all MAGTF commanders and planners. The intelligence estimate is the principal comprehensive intelligence product that does this. The intelligence estimate seeks to accomplish a number of critical tasks: to state conditions of the area of operations that exist and indicate the effect of these conditions on enemy capabilities and the assigned mission, and assess the estimated effects of these conditions on both enemy and friendly capabilities and operations; to provide basic and current intelligence on threat forces compositions, organizations, strengths, dispositions, locations, activities, C2, logistics, and equipment; to provide an assessment of each en-

emy capability (attack, defend, delay, reinforce, withdraw), to include strengths and vulnerabilities, indicators that point to possible adoption of the capability, and estimates of the effects the enemy's adoption of each capability will have on the accomplishment of the MAGTF's mission; and, finally, intelligence conclusions of the likelihood of each capability being adopted by the enemy (generally listed from the most to least probable) and its associated center of gravity and vulnerabilities and estimated exploitability of these by the MAGTF. The intelligence estimate is an all-source intelligence product that will contain substantial input from IMINT and usually supported by extensive imagery. Additionally, it is where the following intelligence studies will be found, each requiring substantial IMINT and imagery support:

- Tab A, Tactical Study of Terrain.
- Tab B, Beach Studies.
- Tab D, Airfield Studies.
- Tab E, HLZs, and Drop Zones Studies.
- Tab F, Port Studies.
- Tab G, Lines of Communications Studies.
- Tab H, Order of Battle Study.
- Tab I, Survival, Evasion, Resistance, and Escape Safe Areas.

The intelligence estimate and supporting studies will be updated periodically (or new ones developed) throughout an operation, generally through all-source intelligence reports and summaries (again, each will usually have substantial input from IMINT and supporting imagery). The intel bn commander/ISC, through the commander's P&A cell OIC, is responsible for the analysis underlying and preparation of the intelligence estimate and subsequent reports.

Appendix 14 (Reconnaissance and Surveillance Plan)

The reconnaissance and surveillance (R&S) plan is a key tool developed to coordinate and integrate MAGTF R&S operations. Specifically, it provides

guidance and orders for establishing and conducting ground reconnaissance, aerial reconnaissance, UAV operations, and remote sensor operations. The R&S plan will generally be developed by the SARC OIC, under the supervision of the intel bn commander/ISC and the CMDO, with the assistance of senior IMINT and R&S planners from force reconnaissance company, UAV squadron, and the ground sensor platoon (GSP). In particular, the following two tabs to the R&S plan appendix require extensive support from IMINT planners.

Tab C, Unmanned Aerial Vehicle Plan

This tab provides detailed intelligence orders, guidance and instructions for MAGTF UAV operations. Responsibility for its development rests with the SARC OIC, assisted by UAV squadron and imagery planners. Its specific content and formats will be mission and situation dependent. It will include information on UAV sortie routine and surge capabilities; preplanned point, route, strip, and area reconnaissance missions; UAV squadron C2 nodes locations; allocation and capabilities of squadron elements (e.g., RRS team assignments and missions); and other similar information. Although it may include tentative planning information on specific PIR and IRs supported as well as type imagery desired, usually this information will be too perishable; instead, when developed it will be incorporated in subsequent specific intelligence mission orders. (See appendix L for a recommended format for a MAGTF UAV plan.)

Tab D, Aerial Imagery Plan

This tab provides detailed intelligence orders, guidance, and instructions for the conduct of MAGTF aerial imagery operations. Responsibility for its development rests with the SARC OIC, assisted by imagery planners. Its specific content and formats will be mission and situation dependent. Generally it will include information on ACE imagery capable aircraft and systems capabilities and sortie routine and surge capabilities; preplanned point, route, strip and area reconnaissance missions; key C2

nodes locations; allocation and capabilities of squadron elements; and other similar information. Although it may include tentative planning information on specific PIR and IRs supported as well as type imagery desired, usually this information will be too perishable. When developed it will be incorporated in subsequent specific intelligence mission orders. (See appendix M for a recommended format for a MAGTF aerial imagery plan.)

Appendix 16 (Intelligence Operations Plan)

This appendix may be developed depending upon the complexity and scope of MAGTF operations and supporting intelligence operations (to include IMINT). It will provide additional guidance not already covered in SOPs for planning and direction of all-source intelligence and CI operations; and for intelligence C2, C2 nodes and facilities, and supporting CIS. It will also identify priority and unique requirements and procedures for the integration of MAGTF intelligence operations with MAGTF C2, maneuver, fires, logistics, and force protection operations; and the integration and interoperability of MAGTF intelligence operations with naval, JTF, theater, national and non-US intelligence operations. The following separate tabs may be included.

Tab A, Intelligence Collections Plan

Provide guidance for executing and managing collection activities not otherwise covered by regulation or SOP, including reconnaissance operations, equipment status, reports, unique intelligence disciplines requirements, and other specialized forms of collection activity to support the plan. Provide guidance on both routine and time-sensitive reporting of collected intelligence information by all collection sources to be employed in support of the plan.

Tab B, Intelligence Production Plan

Identify the intelligence production objectives and effort, including any intelligence and CI

products, required to support the OPLAN. Include details of management of intelligence production requirements along with guidance on intelligence production and data bases, forms/formats for intelligence products, production schedules, intelligence products and reports distribution, etc. Include as appropriate requirements and guidance for the following: I&W, support to targeting, combat assessment (to include BDAs), and force protection.

Tab C, Intelligence Dissemination Plan

Stipulate the requirements, means, and formats for disseminating intelligence reports and products (e.g., units responsible for each, periods covered, distribution, timelines standards). Establish the supporting intelligence communications and information systems plan and the supporting procedures and criteria to satisfy expanded requirements for vertical and lateral dissemination of routine and time-sensitive intelligence products and reports. Address voice, network, courier, briefings, and other communications methods, to include point-to-point and alarm methods. Establish alternate means to ensure that required intelligence will be provided to subordinate and supported units. Provide guidance regarding intelligence and information security, to include the dissemination of sensitive compartmented information within the force and the releasability of intelligence to non-US forces.

Tab D, Intelligence Communications and Information Systems Plan

Provide any specific instruction necessary regarding the establishment, operation, and maintenance of intelligence and pertinent supporting CIS resources and databases, to include those dedicated to intelligence operations as well as multipurpose MAGTF CIS resources used for intelligence purposes.

Note: This tab may be consolidated with Tab C.

Tab E, Intelligence Reports

Provide any instructions necessary regarding intelligence reports, both all-source and single discipline.

Appendix 17 (Support to Survival, Evasion, Resistance, and Escape)

The support to survival, evasion, resistance and escape (SERE) appendix provides guidance, procedures, intelligence products and orders for intelligence support to MAGTF SERE preparations and operations. A variety of intelligence products are developed to support MAGTF SERE readiness. Together with Tab I (Survival, Evasion, Resistance, and Escape Safe Areas) to Appendix 11 (Intelligence Estimate) these constitute the standard SERE support products. The P&A cell OIC is responsible for preparing these products. IMINT and, critically, imagery provide key support to each SERE support intelligence product. These include:

- SERE guides and bulletins. They provide basic information to help an individual survive, successfully evade and, if captured, resist enemy interrogations. The guidelines and bulletins cover an entire country or region and provide information on topography, hydrography, food and water sources, safe and dangerous plants and animals, customs and cultures, recognition of hostile forces, resistance techniques, and other types of information.
- Select areas for evasion (SAFE) area intelligence descriptions (SAID). SAIDs provide essential intelligence concerning specific SAFEs to assist evasion and resistance planners and potential evaders in planning and conducting recovery operations.
- Evasion and recovery (E&R) studies. E&R studies are similar to SAIDs. They differ in that not all conventional selection criteria for SAFE areas can be met because of current political, military or environmental factors prevailing within the area.

APPENDIX A. IMAGING SENSORS

Optical Cameras

Optical cameras detect and record electromagnetic radiation within the visible light and near-infrared portions of the electromagnetic spectrum. The operation principles are the same as for a common box camera. There are three types of optical imaging systems—vertical, oblique, and panoramic.

Vertical

The optical axis of the camera is approximately perpendicular to the surface of the earth (see figure A-1). Vertical imagery is ideal for performing terrain analysis, beach studies, and HLZ studies.

Oblique

Oblique imagery is obtained by imaging the ground at an angle to the vertical. The optical axis

of the sensor is intentionally directed between the horizontal and the vertical. This axis can provide left or right oblique coverage. Oblique imagery requires oblique metrics, and is also ideal for observation at canopy baseline.

There are two standard types of oblique imagery, high and low. High oblique imagery (see figure A-2 on page A-2) will include the horizon, while low oblique imagery (see figure A-3 on page A-2) will not. Because of the angle, high oblique imagery covers a larger area than low oblique. Oblique imagery is referred to as left or right oblique or forward looking, based on the look angle in respect to the platform.

Panoramic

Panoramic imagery is taken with a special camera that is able to scan a wide area. The optical axis of the camera utilizes a system of optics that can scan

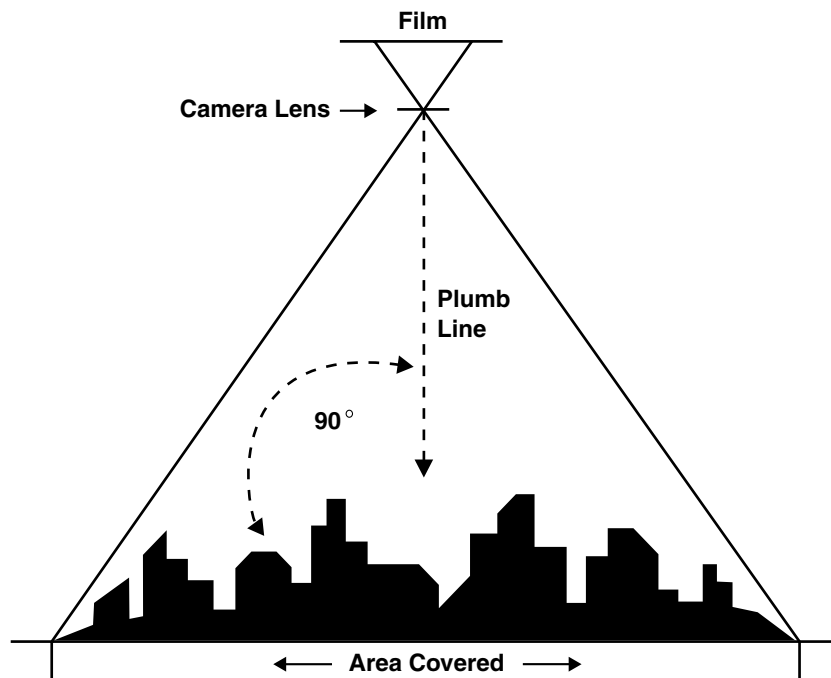

Figure A-1. Relationship of a Vertical Aerial Image with the Ground.

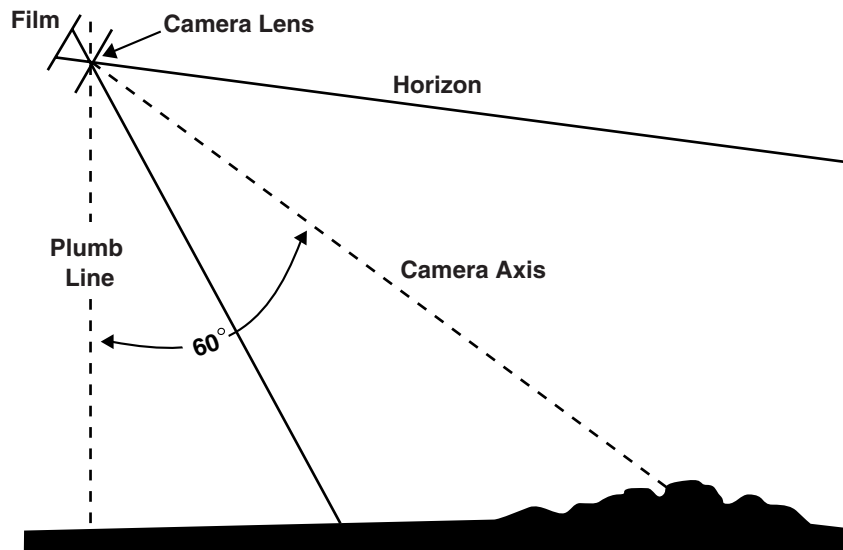

Figure A-2. Relationship of High Oblique Photograph to the Ground.

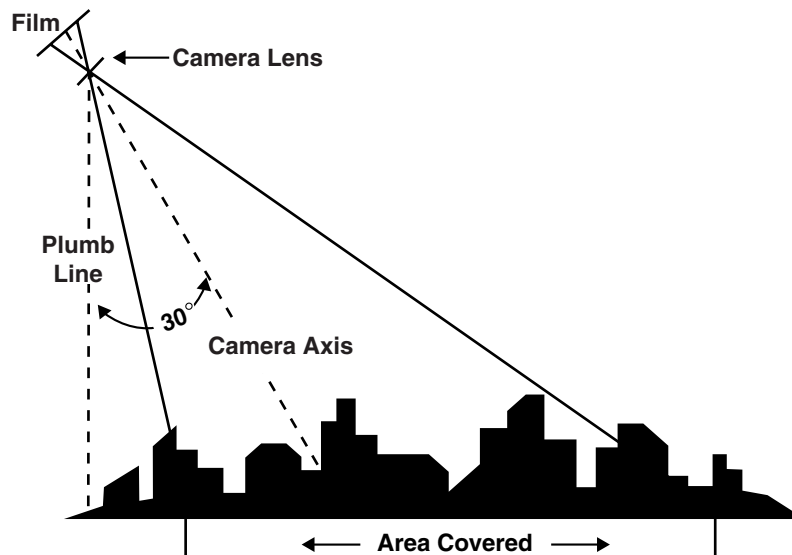

Figure A-3. Relationship of Low Oblique Imagery to the Ground.

an area from 0 to 180 degrees. There are two types of panoramic imagery, low and high.

- Low panoramic imagery (see figure A-4) is taken at low altitudes and scans a wide angle that includes the horizon at either side of the aircraft flight path.
- High panoramic imagery (see figure A-5) is taken at high altitudes with a smaller scan angle.

The horizon is not normally visible on high panoramic imagery. In only one pass over the target area, panoramic photography provides coverage of large areas of terrain on both sides of the aircraft flight path. Although it provides both vertical and oblique views of the image area, it is the most difficult and time-consuming photography to analyze and measure, owing to the distortion of the recorded image. Table A-1 on page A-4

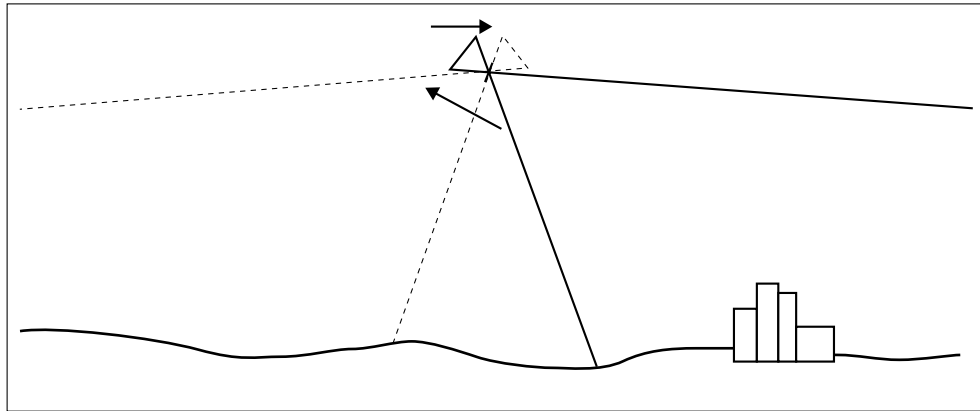

Figure A-4. Low Panoramic Imagery.

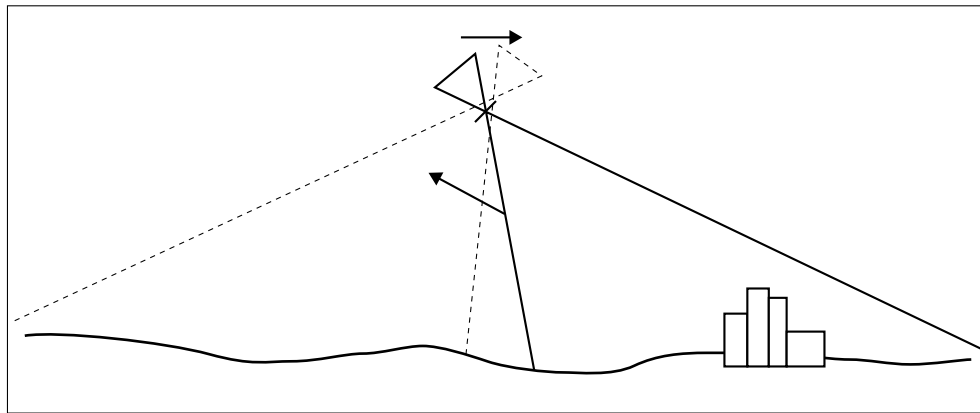

Figure A-5. High Panoramic Imagery.

summarizes both the advantages and disadvantages of each type of imaging system.

Capabilities of optical sensors are—

- High quality photograph (good resolution).
- Passive system, which cannot be detected or jammed.
- Flexibility of sensors.

Limitations of optical sensors are—

- Light source needed.
- Hampered during periods of reduced visibility.

- Susceptible to enemy deception.
- LOS dependent.

High Resolution Radar

Radar is an active sensing technique that detects and records differences in reflected electromagnetic energy.

Capabilities of high resolution radar are—

- Offers day and night operations.
- All-weather capability.
- Standoff capability.

Table A-1. Advantages and Disadvantages of Imaging Systems.

Sensor System	Advantages	Disadvantages
Vertical	Fairly constant scale. Can construct mosaics. Obtains accurate measurements. Allows stereographic viewing. Accurate interpretation.	Aircraft or air vehicles must fly directly over the target. Objects under overhead cover cannot be viewed. Unnatural view angle. Some areas are inaccessible due to restrictions in over-flights (tactical systems).
Oblique	Large area coverage. More natural view. Aircraft or air vehicle does not fly over the target. Can view objects under cover due to angle.	Terrain masking. Scale varies. Measurements difficult.
Panoramic	Large area coverage. Satisfies both vertical and oblique mission requirements.	Scale varies. Aircraft has limited standoff capability. Measurements difficult.

Limitations of high resolution radar are—

- Poor resolution.
- Active sensing techniques.
- LOS dependent.

Infrared

Infrared (IR) sensors detect and record electromagnetic radiation that is emitted from a given

target surface in the IR portion of the electromagnetic spectrum.

Capabilities of IR are—

- Offers day and night operations.
- Has passive sensing techniques.
- Detects camouflage equipment and activity.

Limitations of IR are—

- Poor resolution.
- Susceptible to enemy deception.
- Hampered by rain, snow, hail, etc.
- LOS dependent.

APPENDIX B. NATIONAL IMAGERY INTERPRETABILITY RATING SCALE

Background

Imagery analysts use the National Imagery Interpretability Rating Scale (NIIRS) to define and measure the quality of images and performance of imaging systems. Through a process referred to as rating an image, the NIIRS is used by imagery analysts to assign a number indicating the interpretability of a given image. The NIIRS concept provides a means to directly relate the quality of an image to the interpretation tasks for use. Although the NIIRS has been primarily applied in the evaluation of aerial imagery, it also provides a systematic approach to measuring the quality of photographic or digital imagery, the performance of image capture devices, and the effects of image processing algorithms.

The NIIRS is a task-based scale consisting of nine graduated levels. At each level, representative exploitation tasks (termed criteria) indicate the level of information extracted with an image of a given interpretability level. For example, with a NIIRS 2 image, imagery analysts should be able to detect large hangars at an airfield, while with a NIIRS 8 image; they should be able to identify the rivet lines on bomber aircraft. At a higher NIIRS level, more detailed information can be obtained from an image.

The NIIRS is designed to relate to a wide range of image quality. A NIIRS level of 0 is defined as having no value for intelligence purposes. The definition of that level is open to debate. The upper end of the scale is defined by the best available imagery of a given type; i.e., a portion of the spectrum. The upper end of a scale is not necessarily indicative of any specific operational system.

The NIIRS measures the information potential; i.e., interpretability of an image. This means that specific objects listed in the criteria need not be

present, but the physical attributes of the image are such that the image would have the specified information value if the necessary content were present. The NIIRS relies on the experience of imagery analysts to be able to extrapolate, or imagine, how well criteria would be rendered if those features were present in the image to be rated. Because each rating refers to specific tasks the imagery analyst can or could do, it has a more precise meaning than, for example, when such subjective words as good or fair are used. Thus, judgments become more uniform, because imagery analysts can use the same yardstick to measure interpretability.

The NIIRS accounts for the major factors that affect image interpretability. Image resolution, measured as ground resolved distance or ground sample distance, has a significant effect on interpretability. Spatial resolution alone does not determine the NIIRS of an image, since sharpness, noise, and contrast also influence the NIIRS. These effects may be due to system parameters (e.g., optical quality, focal plane characteristics), acquisition conditions (e.g., sun angle, atmospheric haze), and exploitation conditions (e.g., duplicate film quality, softcopy monitor quality). By design, the NIIRS is independent of a particular imaging system. NIIRS ratings and ranges are—

NIIRS Rating	Range in Meters
0	N/A
1	over 9.0
2	4.5–9.0
3	2.5–4.5
4	1.2–2.5
5	0.75–1.2
6	0.40–0.75
7	0.20–0.40
8	0.10–0.20
9	less than 0.10

Principal Uses of NIIRS

There are several primary uses for the NIIRS. These are—

- Communicating imagery interpretability. (Can this image answer the IR, both now and archived?)
- Developing collection requirements. (Can an imagery system collect the required information? Can the currently available imagery missions collect the information?)
- Assessing mission collection satisfaction. (Does the image satisfy the intelligence requirement?)
- Assessing technical performance. (Is the imagery system working as planned?)

Procedure for Assigning NIIRS Rating Levels Criteria

The NIIRS criteria are expressed in terms of detect, identify or distinguish between objects, features or activities.

Detect is the capability to find or discover the presence or existence of an installation, object, activity or item of intelligence interest based on its general shape (configuration) and on other contextual information in the scene. Some level of identification is implied in detection, so that the relatively gross feature or item detected can be properly named or classified.

Identify is the capability to name an object by type or class based primarily on its configuration and detailed components. As used in NIIRS,

identification is based on observation of actual physical detail and not through information from other sources.

Distinguish between is the capability to determine that two detected objects are of different types or classes based on one or more distinguishing features.

Guidelines

The following guidelines allow NIIRS to be used to communicate image interpretability, to evaluate mission performance, and to plan for new imagery systems.

- When assigning a NIIRS level, the imagery analyst evaluates a target within an imagery segment or the entire area on the segment, as necessary, to meet the imagery analyst's task. The imagery analyst will assign a NIIRS level that best characterizes the overall interpretability of the target or area.
- The imagery analyst should neither ignore nor emphasize exceptionally good or poor portions of the image segment.
- When considering clouds, shadows or other localized degradations, the imagery analyst rates the target or area with NIIRS level 0 only when the degradation precludes using it for interpretation. If the area of interest is degraded but interpretable, the imagery analyst should assign a NIIRS that best represents its interpretability.
- The imagery analyst should ignore shadows cast by individual items of intelligence interest.

SECTION I. VISIBLE NATIONAL IMAGERY INTERPRETABILITY RATING SCALE

NIIRS Rating	Description
0	Interpretability of the imagery is precluded by obscuration, degradation or very poor resolution.
1	Detect a medium-sized port facility and/or distinguish between taxiways and runways at a large airfield.
2	Detect large hangars at airfields. Detect large static radars (e.g., AN/FPS-85, COBRA DANE, PECHORA, HENHOUSE). Detect military training areas. Identify an SA-5 site based on road pattern and overall site configuration. Detect large buildings at a naval facility (e.g., warehouses, construction hall). Detect large buildings (e.g., hospitals, factories).
3	Identify the wing configuration (e.g., straight, swept delta) of all large aircraft (e.g., 707, CONCORD, BEAR, BLACKJACK). Identify radar and guidance areas at a SAM site by the configuration, mounds, and presence of concrete aprons. Detect a helipad by the configuration and markings. Detect the presence/absence of support vehicles at a mobile missile base. Identify a large surface ship in port by type (e.g., cruiser, auxiliary ship, noncombatant/merchant). Detect trains or strings of standard rolling stock on railroad tracks (not individual cars).
4	Identify all large fighters by type (e.g., FENCER, FOXBAT, F-15, F-14). Detect the presence of large individual radar antennas (e.g., TALL KING). Identify, by general type, tracked vehicles, field artillery, large river-crossing equipment, wheeled vehicles when in groups. Detect an open missile silo door. Determine the shape of the bow (pointed or blunt/rounded) on a medium-sized submarine (e.g., ROMEO, HAN, Type 209, CHARLIE II, ECHO II, VICTOR III/III). Identify individual tracks, rail pairs, control towers, and switching points in rail yards.
5	Distinguish between a MIDAS and a CANDID by the presence of refueling equipment (e.g., pedestal and wing pod). Identify radar as vehicle-mounted or trailer-mounted. Identify, by type, deployed tactical SSM systems (e.g., FROG, SS-21, SCUD). Distinguish between SS-25 mobile missile TEL and missile support vans in a known support base, when not covered by camouflage. Identify TOP STEER or TOP SAIL air surveillance radar on KIROV-, SOVREMENNY-, KIEV-, SLAVA-, MOSKVA-, KARA-, or KRESTA-II-class vessels. Identify individual rail cars by type (e.g., gondola, flat, box) and/or locomotives by type (e.g., steam, diesel).
6	Distinguish between models of small/medium helicopters (e.g., HELIX A from HELIX B from HELIX C, HIND D from HIND E, HAZE A from HAZE B from HAZE C). Identify the shape of antennas on EW/GCI/ACQ radars as parabolic, parabolic with clipped corners or rectangular. Identify the spare tire on a medium-sized truck. Distinguish between SA-6, SA-11, and SA-17 missile airframes. Identify individual launcher covers (8) of vertically launched SA-N-6 on SLAVA-class vessels. Identify automobiles as sedans or station wagons.
7	Identify fitments and fairings on a fighter-sized aircraft (e.g., FULCRUM, FOXHOUND). Identify ports, ladders, and vents on electronics vans. Detect the mount for antitank guided missiles (e.g., SAGGER on BMP-1). Detect details of the silo door hinging mechanism on Type III-F, III-G, and II-H launch silos and Type III-X launch control silos. Identify the individual tubes of the RBU on KIROV-, KARA-, and KRIVAK-class vessels. Identify individual rail ties.
8	Identify the rivet lines on bomber aircraft. Detect horn-shaped and W-shaped antennas mounted atop BACKTRAP and BACKNET radars. Identify a hand-held SAM (e.g., SA-7/14, REDEYE, STINGER). Identify joints and welds on a TEL or TELAR. Detect winch cables on deck-mounted cranes. Identify windshield wipers on a vehicle.
9	Differentiate cross-slot from single slot heads on aircraft skin panel fasteners. Identify small light-toned ceramic insulators that connect wires of an antenna canopy. Identify vehicle registration numbers (VRNs) on trucks. Identify screws and bolts on missile components. Identify braid of ropes (1 to 3 inches in diameter). Detect individual spikes in railroad ties.

SECTION II. INFRARED NATIONAL IMAGERY INTERPRETABILITY RATING SCALE

NIIRS Rating	Description
0	Interpretability of the imagery is precluded by obscuration, degradation or very poor resolution.
1	Distinguish between runways and taxiways on the basis of size, configuration or pattern at a large airfield. Detect a large (e.g., greater than 1 square kilometer) cleared area in dense forest. Detect large ocean-going vessels (e.g., aircraft carrier, super-tanker, KIROV) in open water. Detect large areas (e.g., greater than 1 square kilometer) of marsh/swamp.
2	Identify individual thermally active engine vents. Detect large aircraft (e.g., C-141, 707, BEAR, CANDID, CLASSIC). Detect individual large buildings (e.g., hospitals, factories) in an urban area. Distinguish between densely wooded, sparsely wooded, and open fields. Identify an SS-25 base by the pattern of buildings and roads. Distinguish between naval and commercial port facilities based on type and configuration of large functional areas.
3	Distinguish between large (e.g., C-141, 707, BEAR, A-300 AIRBUS) and small aircraft (e.g., A-4, FISHBED, L-39). Identify individual thermally active flues running between the boiler hall and smoke stacks at a thermal power plant. Detect a large air warning radar site based on the presence of mounds, revetments, and security fencing. Detect a driver-training track at a ground forces garrison. Identify individual functional areas (e.g., launch sites, electronics area, support area, missile handling area) of an SA-5 launch complex. Distinguish between large (e.g., greater than 200 meter) freighters and tankers.
4	Identify the wing configuration of small fighter aircraft (e.g., FROGFOOT, F-16, FISHBED). Detect a small (e.g., 50 meter square) electrical transformer yard in an urban area. Detect large (e.g., greater than 10-meter diameter) environmental domes at an electronics facility. Detect individual thermally active vehicles in garrison. Detect thermally active SS-25 missile support vans in garrison. Identify individual closed cargo hold hatches on large merchant ships.
5	Distinguish between single-tail (e.g., FLOGGER, F-16, TORNADO) and twin-tailed (e.g., F-15, FLANKER, FOXBAT) fighters. Identify outdoor tennis courts. Identify the metal lattice structure of large (e.g., approximately 75 meter) radio relay towers. Detect armored vehicles in a revetment. Detect a deployed transportable electronics tower at an SA-10 site. Identify the stack shape (e.g., square, round, oval) on large (e.g., greater than 200 meters) merchant ships.
6	Detect wing-mounted stores (i.e., ASM, bombs) protruding from the wings of large bombers (e.g., B-52, BEAR, BADGER). Identify individually thermally active engine vents atop diesel locomotives. Distinguish between a FIX FOUR and FIX SIX site based on antenna pattern and spacing. Distinguish between thermally active tanks and APCs. Distinguish between a 2-rail and 4-rail SA-3 launcher. Identify missile tube hatches on submarines.
7	Distinguish between ground attack and interceptor versions of the MIG-23 FLOGGER based on the shape of the nose. Identify automobiles as sedans or station wagons. Identify antenna dishes (less than 3 meters in diameter) on a radio relay tower. Identify the missile transfer crane on an SA-6 transloader. Distinguish between an SA-2/CSA-1 and a SCUD-B missile transporter when missiles are not loaded. Detect mooring cleats or bollards on piers.
8	Identify the RAM air scoop on the dorsal spine of FISHBED J/K/L. Identify limbs (e.g., arms, legs) on an individual. Identify individual horizontal and vertical ribs on a radar antenna. Detect closed hatches on a tank turret. Distinguish between fuel and oxidizer multi-system propellant transporters based on twin or single fitments on the front of the semi-trailer. Identify individual posts and rails on deck edge life rails.
9	Identify access panels on fighter aircraft. Identify cargo (e.g., shovels, rakes, ladders) in an open bed, light-duty truck. Distinguish between BIRDS EYE and BELL LACE antennas based on the presence or absence of small dipole elements. Identify turret hatch hinges on armored vehicles. Identify individual command guidance strip antennas on an SA-2/CSA-1 missile. Identify individual rungs on bulkhead-mounted ladders.

SECTION III. RADAR NATIONAL IMAGERY INTERPRETABILITY RATING SCALE

NIRS Rating	Description
0	Interpretability of the imagery is precluded by obscuration, degradation or very poor resolution.
1	Detect the presence of aircraft dispersal parking areas. Detect a large cleared swath in a densely wooded area. Detect, based on presence of piers and warehouses, a port facility. Detect lines of transportation (either road or rail), but do not distinguish between.
2	Detect the presence of large (e.g., BLACKJACK, CAMBER, COCK, 707, 747) bombers or transports. Identify large phased-array radars (e.g., HEN HOUSE, DOG HOUSE) by type. Detect a military installation by building pattern and site configuration. Detect road pattern, fence and hardstand configuration at SSM launch sites (missile silos, launch control silos) within a known ICBM complex. Detect large non-combatant ships (e.g., freighters or tankers) at a known port facility. Identify athletic stadiums.
3	Detect medium-sized aircraft (e.g., FENCER, FLANKER, CURL, COKE, F-15). Identify an ORBITA site on the basis of a 12-meter dish antenna normally mounted on a circular building. Detect vehicle revetments at a ground forces facility. Detect vehicles/pieces of equipment at a SAM, SSM or ABM fixed missile site. Determine the location of the superstructure (e.g., fore, amidships, aft) on a medium-sized freighter. Identify a medium-sized (approx. six track) railroad classification yard.
4	Distinguish between large rotary-wing and medium fixed-wing aircraft (e.g., HALO helicopter vs. CRUSTY transport). Detect recent cable scars between facilities or command posts. Detect individual vehicles in a row at a known motor pool. Distinguish between open and closed sliding roof areas on a single bay garage at a mobile missile base. Identify square bow shape of ROPUCHA class (LST). Detect all rail/road bridges.
5	Count all medium helicopters (e.g., HIND, HIP, HAZE, HOUND, PUMA, WASP9). Detect deployed TWIN EAR antenna. Distinguish between river-crossing equipment and medium/heavy armored vehicles by size and shape (e.g., MTU-20 vs. T-62 MBT). Detect missile support equipment at an SS-25 RTP (e.g., transporter-erector-launcher, missile support van). Distinguish bow shape and length/width differences of SSNs (attack submarines, nuclear). Detect the break between railcars (count railcars).
6	Distinguish between variable and fixed-wing fighter aircraft (e.g., FENCER vs. FLANKER). Distinguish between the BAR LOCK and SIDE NET antennas at a BAR LOCK/SIDE NET acquisition radar site. Distinguish between small support vehicles (e.g., UAZ-69, UAZ-469) and tanks (e.g., T-72, T-80). Identify SS-24 launch triplet at a known location. Distinguish between the raised helicopter deck on a KRESTA II (CG) and the helicopter deck with main deck on a KRESTA I (CG). Identify a vessel by class when singly deployed (e.g., YANKEE I, DELTA I, KRIVAKII FFG). Detect cargo on a railroad flatcar or in a gondola.
7	Identify small fighter aircraft by type (e.g., FISHBED, FITTER, FLOGGER). Distinguish between electronics van trailers (without tractor) and van trucks in garrison. Distinguish, by size and configuration, between a turreted, tracked APC and a medium tank (e.g., BMP-1/2 vs. T-64). Detect a missile on the launcher in an SA-2 launch revetment. Distinguish between bow mounted missile system on KRIVAK I/II and bow mounted gun turret on KRIVAK III. Detect road/street lamps in an urban, residential area or military complex.
8	Distinguish the fuselage difference between a HIND and a HIP helicopter. Distinguish between the FAN SONG E missile control radar and the FAN SONG F based on the number of parabolic dish antennas (three vs. one). Identify the SA-6 transloader when other SA-6 equipment is present. Distinguish limber hole shape and configuration differences between DELTA I and YANKEE I (SSBNs). Identify the dome/vent pattern on rail tank cars.
9	Detect major modifications to large aircraft (e.g., Airings, pods, wingless). Identify the shape of antennas on EW/GCI/ACQ radars as parabolic, parabolic with clipped corners or rectangular. Identify, based on presence or absence of turret, size of gun tube, and chassis configuration, wheeled or tracked APCs by type (e.g., BTR-80, BMP-1/2, MT-LB, M113). Identify the forward fins on an SA-3 missile. Identify individual hatch covers of vertically launched SA-N-6 surface-to-air system. Identify trucks as cab-over-engine or engine-in-front.

SECTION IV. MULTISPECTRAL NATIONAL IMAGERY INTERPRETABILITY RATING SCALE

The traditional OOB criteria categories (air, electronic, ground, missile, and naval) found in the NIIRS are not present in the multispectral imagery (MSI) national imagery interpretability rating

scale. Five new categories more relevant to MSI exploitation were developed: military, urban/industrial/lines of communication, vegetation/agricultural, terrain, and water resources.

NIIRS Rating	Description
1	Distinguish between urban and rural areas. Identify a large wetland (greater than 100 acres). Detect meander flood plains (characterized by features such as channel scars, oxbow lakes, meander scrolls). Delineate coastal shoreline. Detect major highway and rail bridges over water (e.g., Golden Gate, Chesapeake Bay). Delineate extent of snow or ice cover.
2	Detect multilane highways. Detect strip mining. Determine water current direction as indicated by color differences (e.g., tributary entering larger water feature, chlorophyll or sediment patterns). Detect timber clear-cutting. Delineate extent of cultivated land. Identify riverine flood plains.
3	Detect vegetation/soil moisture differences along a linear feature (suggesting the presence of a fence line). Identify major street patterns in urban areas. Identify golf courses. Identify shoreline indications of predominant water currents. Distinguish among residential, commercial, and industrial areas within an urban area. Detect reservoir depletion.
4	Detect recently constructed weapon positions (e.g., tank, artillery, self-propelled gun) based on the presence of revetments, berms, and ground scarring in vegetated areas. Distinguish between two-lane improved and unimproved roads. Detect indications of natural surface airstrip maintenance or improvements (e.g., runway extension, grading, resurfacing, bush removal, vegetation cutting). Detect landslide or rockslide large enough to obstruct a single-lane road. Detect small boats (15–20 feet in length) in open water. Identify areas suitable for use as light fixed-wing aircraft (e.g., Cessna, Piper Cub, Beechcraft) landing strips.
5	Detect automobile in a parking lot. Identify beach terrain suitable for amphibious landing operation. Detect ditch irrigation of beet fields. Detect disruptive or deceptive use of paints or coatings on buildings/structures at a ground forces installation. Detect raw construction materials in ground forces deployment areas (e.g., timber, sand, gravel).
6	Detect summer woodland camouflage netting large enough to cover a tank against a scattered tree background. Detect foot trail through tall grass. Detect navigational channel markers and mooring buoys in water. Detect livestock in open but fenced areas. Detect recently installed minefields in ground forces deployment area based on a regular pattern of disturbed earth or vegetation. Count individual dwellings in subsistence housing areas (e.g., squatter settlements, refugee camps).
7	Distinguish between tanks and three-dimensional tank decoys. Identify individual 55-gallon drums. Detect small marine mammals (e.g., harbor seals) on sand/gravel beaches. Detect underwater pier footings. Detect foxholes by ring of spoil outlining hole. Distinguish individual rows of truck crops.
8–9	Not applicable.

SECTION V. CIVIL NATIONAL IMAGERY INTERPRETABILITY RATING SCALE

The Civil National Imagery Interpretability Rating Scale (NIIRS) supplements the Visible NIIRS by expanding the number of criteria categories.

NIIRS Rating	Description
0	Interpretability of the imagery is precluded by obscuration, degradation or very poor resolution.
1	Distinguish between major land use classes (urban, agricultural, forest, water, barren). Detect a medium sized port facility. Distinguish between runways and taxiways at a large airfield. Identify large area drainage patterns by type (dendritic, trellis, radial).
2	Identify large (greater than 160 acres) center pivot irrigated fields during the growing season. Detect large buildings (hospitals, factories). Identify road patterns, like clover leaves, on major highway systems. Detect icebreaker tracks. Detect the wake from a large (greater than 300 feet) ship.
3	Detect large area (larger than 160 acres) contour plowing. Detect individual houses in residential neighborhoods. Detect trains or strings of standard rolling stock on railroad tracks (not individual cars). Identify inland waterways navigable by barges. Distinguish between natural forest stands and orchards.
4	Identify farm buildings as barns, silos, or residences. Count unoccupied railroad tracks along right-of-way or in a railroad yard. Detect basketball court, tennis court, and volleyball court in urban areas. Identify individual tracks, rail pairs, control towers, and switching points in rail yards. Detect jeep trails through grassland.
5	Identify Christmas tree plantations. Identify individual rail cars by type (gondola, flat, box) and locomotives by type (steam, diesel). Detect open-bay doors of vehicle storage buildings. Identify tents (larger than 2 person) at established recreational camping areas. Distinguish between stands of coniferous and deciduous trees during leafoff condition. Detect large animals (elephants, rhinoceros, and giraffes) in grassland.
6	Detect narcotics intercropping based on texture. Distinguish between row (corn and soybean) crops and small grain (wheat and oats) crops. Identify automobiles as sedans or station wagons. Identify individual telephone and electric poles in residential neighborhoods. Detect foot trails through barren areas.
7	Identify individual mature cotton plants in a known cotton field. Identify individual railroad ties. Detect individual steps on a stairway. Detect stumps and rocks in forest clearings and meadows.
8	Count individual baby pigs. Identify a U.S. Geological Survey benchmark set in a paved surface. Identify grill detailing and/or the license plate on a passenger or truck-type vehicle. Identify individual pine seedlings. Identify individual water lilies on a pond. Identify windshield wipers on a vehicle.
9	Identify individual grain heads on small grain (wheat, oats, and barley). Identify individual barbs on a barbed wire fence. Detect individual spikes in railroad ties. Identify individual bunches of pine needles. Identify an ear tag on large game animals (deer, elk, moose).

APPENDIX C. REQUEST FORMATS FOR AERIAL IMAGERY COLLECTION MISSIONS

Section I. Joint Tactical Air Reconnaissance/ Surveillance (JTAR/S) Request Format

PRECEDENCE

FROM:

TO:

INFO:

CLASSIFICATION

SUBJ: JTAR/S REQ

L. REQUEST NO. ___ PREPLANNED A. PRIORITY B. PRECEDENCE ___
 IMMEDIATE C. PRIORITY

M. DATE/TIME FACTORS

1. DATE MISSION DESIRED
2. TOT (IF REQ)
3. LTIOV
4. PRIOR COVERAGE ACCEPTABLE (DAYS PRIOR)

N. TYPE RECON REQUESTED

1. TYPE MISSION

- A. VISUAL
- B. IMAGERY
- C. ELECTRONIC

2. TYPE COVERAGE

- A. PINPOINT
- B. STRIP/LINES OF COMMUNICATION
- C. ROUTE RECONNAISSANCE
- D. AREA SEARCH
- E. AREA COVERAGE
- F. AFLOAT

*3. SENSOR TYPE

- A. OPTICAL
- B. INFRARED
- C. SLAR
- D. ELECTRONIC
- E. LASER
- F. OTHER

*4. TYPE PHOTO

- A. VERTICAL
- B. OBLIQUE
- C. PANORAMIC

*5. TYPE FILM

- A. BLACK AND WHITE
- B. COLOR
- C. CAMOUFLAGE DETECTING

6. STEREO PHOTO

- A. NOT REQUIRED
- B. REQUIRED

O. MAP REFERENCE

TYPE AND SCALE _____
SERIES _____
SHEET _____
EDITION _____
DATE _____

P. TARGET COORDINATES

- 1. UTM
- 2. LAT/LONG
- 3. OTHER (SPECIFY)

Q. TARGET CATEGORY/PRIORITY INTELLIGENCE REQUIREMENT(S) (SEE DETAILED INSTRUCTION)

- 1. AIRFIELD
- 2. ARMOR/ARTY/TROOPS/VEH
- 3. BRIDGE
- 4. DEF POS/STRONG PT/GUN
- 5. ELECTRONIC SITE
- 6. HARBOR SITE
- 7. INDUSTRIAL
- 8. LOC
- 9. MIL. INST/STORAGE AREA

10. MISSILE SITE
11. POWER PROD. FACILITY
12. RAILROAD YARD
13. SHIPS
14. OTHER (SPECIFY)

R. REPORTS

1. IN-FLIGHT REPORT (CS/FREQ)_____ VALID FM_____ Z TO_____ Z
(CS/FREQ)_____ VALID FM_____ Z TO_____ Z
2. MISSION REPORT
3. RECEXREP
4. IPIR
5. SUPIR

S. IMAGERY PRODUCTS (IF REQUIRED)

1. TYPE
2. QUANTITY
3. ADDITIONAL INFORMATION

T. DELIVERY ADDRESS

1. UNIT_____
2. AIR DROP (IF REQ): COORDS:_____
- CALL SIGN/FREQ_____
- RUN HEADING (MAG) (OPTIONAL)_____

U. REMARKS/SPECIAL INSTRUCTIONS

1. TARGET AREA CONTROL (CALL SIGN/FREQ)_____
2. OTHER (SPECIFY)_____

Notes:

1. Designate minimum mandatory items for immediate requests.
2. * Indicates use as applicable or when known.
3. The format provided has been published as STANAG 3277 and has been approved by NATO as a standard format for aerial requests. The letters A to K have special significance for certain organizations and are purposely omitted.
4. When submitting message JTAR/S, the paragraph headings are not required, but the alpha-numeric paragraphs will not be changed.
5. Instructions for completing a JTAR/S are on pages C-4 through C-8.

PARAGRAPH LETTERS INSTRUCTIONS

L. REQUEST NUMBER: As directed.

A&C Priority: Use numerical designation below to define the tactical urgency for preplanned and immediate requests.

PRIORITY: It is the responsibility of the requestor to establish the priority.

<u>Priority No.</u>	<u>Definition</u>
1	Takes precedence over all other requests except previously assigned Priority 1 requests. The results of these requests are of paramount importance to the immediate battle situation or objective.
2	The results of these requirements are in support of the general battle situation and will be accomplished as soon as possible after Priority 1 requests. These are requested to gain current battle information.
3	The results of these requests update the intelligence database but do not effect the immediate battle situation.
4	The results of these requests are of a routine nature and will be fulfilled when the reconnaissance effort permits.

M. DATE/TIME FACTORS

1. Self-explanatory.
2. a. State the Time on Target only when required.
b. Justify U2.
3. Latest time intelligence is of value (LTIOV). Indicate, if it is a factor, the LTIOV. Deliver prior to this date/time.
4. Self-explanatory.

N. TYPE RECONNAISSANCE REQUESTED

1. Type Mission—Self-explanatory.
2. Type Coverage
 - a. Pinpoint—Self-explanatory.
 - b. Strip/Lines of Communications—Search continuous photography of a route of LOC.
 - c. Route Reconnaissance—Visual reconnaissance of a route of LOC with photo of targets of military significance.
 - d. Area Search—Visual search of a specified area with photos of targets of military significance.
 - e. Area Coverage—Photographic coverage of a specified area.
 - f. Afloat—Reconnaissance of vessels afloat.
- 3, 4, and 5. Self-explanatory. These lines should be left blank unless it is fully understood what the selected sensor, photo, and film can accomplish.

- O. MAP REFERENCE. Self-explanatory.
- P. TARGET COORDINATES. Provide reference system used and indicate actual coordinates.
- Q. TARGET CATEGORY/PRIORITY INTELLIGENCE REQUIREMENT(S).
Provide the appropriate category and indicate the desired PIR by selecting the number(s) from the target list category below.

CATEGORY 1—AIRFIELD

- A. Activity: Number, type, and location of aircraft.
- B. Runways: Number, orientation, and surface type.
- C. Taxiway and parking areas: Location and shape.
- D. POL: Number, size, and location.
- E. Ammunition storage areas: Number and location.
- F. Hangars: Number, size, and type construction.
- G. Electronic facilities: Number, type, and location.
- H. Defenses: Number, type, and location.
- I. Other: (specify).

CATEGORY 2—ARMOR/ARTY/TROOPS/VEHICLES

- A. Type: Infantry, armor, engineering, artillery, etc.
- B. Number and type of vehicles.
- C. Number and type of armor.
- D. Number and type of artillery.
- E. Activity: Direction of movement, dug in, etc.
- F. Terrain: Description.
- G. Other: (specify).

CATEGORY 3—BRIDGE

- A. Purpose: Flood, rail, over road, etc.
- B. Type: Railroad, vehicular, agricultural, etc.
- C. Construction: Wood, steel, concrete, etc.
- D. Construction: Piers, abutments, approaches, stringers, beam, truss, etc.
- E. Number of spans.
- F. Length and width (height if significant).
- G. Number of lanes/tracks.
- H. Bypass in vicinity of bridge.
- I. Activity.
- J. Other: (specify).

CATEGORY 4—DEFENSIVE POSITIONS/STRONG POINTS/GUNS

- A. Type and size of position or fortification.
- B. Type weapons: Number.
- C. Fire control system.
- D. Supporting positions.
- E. Transportation access.
- F. Routes of ingress and egress.
- G. Nature of surrounding terrain and foliage barriers.
- H. Activity.
- I. Other: (specify).

CATEGORY 5—ELECTRONIC SITE

- A. Type site: Microwave relay, EW, etc.
- B. Antennas: Number and type.
- C. Mobile or permanent.
- D. Primary buildings and support equipment.
- E. Activity.
- F. Security measures.
- G. Size of area.
- H. Other: (specify).

CATEGORY 6—HARBOR/PORT FACILITIES

- A. Type port: Maritime or inland waterway.
- B. Activity.
- C. Berthing and cargo handling facilities.
- D. POL facilities: Type, number, and locations.
- E. Storage facilities.
- F. Shipbuilding and repair facilities.
- G. Transportation.
- H. Defenses.
- I. Other: (specify).

CATEGORY 7—INDUSTRIAL SITE

- A. Type of industry.
- B. Size of area.
- C. Buildings: Number, size, and construction.
- D. Open storage: Quantity by type.
- E. Activity.
- F. Transportation facilities.
- G. Source of power.
- H. Defenses.
- I. Other: (specify).

CATEGORY 8—LINES OF COMMUNICATIONS (LOC)

- A. Type: Road, rail, canal, etc.
- B. Description of the route.
- C. Chokepoints.

- D. Significant activity.
- E. Significant static targets.
- F. Other: (specify).

CATEGORY 9—MILITARY INSTALLATIONS/STORAGE AREAS

- A. Function: Assembly, admin, barracks, depot, etc.
- B. Activity: Number of vehicles and/or personnel.
- C. Size of the area.
- D. Number of buildings: Predominant construction only.
- E. Storage: Type and location.
- F. Transportation.
- G. Defenses.
- H. Other: (specify).

CATEGORY 10—MISSILE SITE

- A. Type.
- B. Launch site: Mobile/fixed, number of pads, etc.
- C. Number and orientation of launchers/number loaded.
- D. Control center: Location and construction.
- E. Number, type, and location antenna(s).
- F. Auxiliary equipment.
- G. Activity.
- H. Defenses.
- I. Other: (specify).

CATEGORY 11—POWER PRODUCTION FACILITY

- A. Type: Nuclear, coal, oil, hydroelectric, etc.
- B. Size and construction.
- C. Boiler/generators: Number and location.
- D. Transformer yard: Size and location.
- E. Cooling towers: Number and location.
- F. Penstock/turbine outlet (hydroelectric).
- G. Activity.
- H. Defenses.
- I. Other.

CATEGORY 12—RAILROAD YARD

- A. Type: Classification, repair, other.
- B. Length and width: Chokepoint to chokepoint.
- C. Number of tracks.
- D. Facilities: Repair shops, roundhouses, other.
- E. Rolling stock.
- F. Defenses.
- G. Other: (specify).

CATEGORY 13—SHIPS

- A. Class/type/number.
- B. Heading/movement.
- C. Nationality.
- D. Identification.
- E. Cargo.
- F. Activity.
- G. Other.

CATEGORY 14—OTHER

Narrative report is rendered under this heading in sufficient detail to ensure that the request or purpose of the mission is satisfied.

R. REPORTS

- 1. IN-FLIGHT—An in-flight report to friendly units.
- 2. MISSION REPORT—A mission report of the results and significant sightings gathered.
- 3. RECONNAISSANCE EXPLOITATION REPORT—A brief, concise, high priority report on time-sensitive targets of significant tactical importance of a perishable nature.
- 4. INITIAL PHOTOGRAPHIC INTERPRETATION REPORT—An initial photo interpretation report that contains intelligence on mission objectives and additional significant intelligence.
- 5. SUPPLEMENTAL PHOTOGRAPHIC INTERPRETATION REPORT—A supplemental photo interpretation report that provides detailed intelligence acquired through a comprehensive study of imagery.

S. IMAGERY PRODUCTS—Specify type and quantity of imagery products required. Only mission essential imagery products should be requested.

T. DELIVERY ADDRESS

- 1. Unit—Delivery address for mission essential imagery products.
- 2. Air Drop—Coordinates, call sign, frequency, and run-in heading for aerial delivery of imagery products.

U. REMARKS/SPECIAL INSTRUCTIONS

- 1. Target Area Control—Indicate, when applicable, the call sign and radio frequency of the control element. Control of the mission will require close coordination with ground forces.
- 2. Other—Self-explanatory (use this space to specify scale if required and to request specific TOT).

Section II. Immediate Joint Tactical Air Reconnaissance/ Surveillance (JTAR/S) Request Format

Source format: Joint Tactical Air Strike Request format.

(Voice Template)

1. UNIT CALLED THIS IS _____ REQUEST # _____

2. B IMMEDIATE _____ C PRECEDENCE _____

PRIORITY _____

3. TARGET IS/NUMBER OF

A. PERS IN OPEN _____/_____

B. PERS DUG IN _____/_____

C. WPNS/MG/RR/AT _____/_____

D. MORTARS/ARTY _____/_____

E. AAA, ADA _____/_____

F. RKTS, MISSILE _____/_____

G. ARMOR _____/_____

H. VEHICLES _____/_____

I. BLDGS _____/_____

J. BRIDGES _____/_____

K. PILLBOX BNKRS _____/_____

L. SUPPLIES, EQUIP _____/_____

M. CNTR (CP, COM) _____/_____

N. AREA _____/_____

O. ROUTE _____/_____

P. MOVING NESW _____/_____

Q. REMARKS _____

4. TARGET LOCATION/ROUTE/AREA IS

A. _____ (COORDINATES)

B. _____ (COORDINATES)

C. _____ (COORDINATES)

D. _____ (COORDINATES)

E. TARGET ELEVATION _____

F. SHEET # _____

G. SERIES _____

H. CHART # _____

5. TARGET TIME/DATE

- A ASAP _____
- B. NLT _____
- C. AT _____
- D.TO _____

6. DESIRED RESULTS/MISSION/PIR_s

(FREE TEXT _____)

7. REMARKS

(FREE TEXT _____)

APPENDIX D. UNMANNED AERIAL VEHICLE SQUADRON EQUIPMENT AND PERFORMANCE CHARACTERISTICS

Pioneer UAV System

The UAV system found in the Marine Corps VMU squadrons consists of the following:

- Pioneer UAV aircraft (see figure D-1).
- Ground control station (GCS) in an S-280 shelter (see figure D-2).
- Tracking control unit (TCU) in an S-250 shelter.
- Portable control station (PCS).
- Remote receiving stations (RRSs) (one to four).
- Rocket-assisted takeoff (RATO) rail and/or truck-mounted pneumatic launchers.
- Arresting gear recovery equipment.

Table D-1 on page D-2 provides Pioneer UAV characteristics.



Figure D-1. Pioneer UAV Aircraft.



Figure D-2. Pioneer UAV Aircraft with GCS.

Table D-1. Pioneer UAV Characteristics.

Altitude	
Service ceiling	15,000 feet
Maximum ceiling	15,000 feet
Endurance	5 to 6.5 hours
Radius of Action	
Nominal	87 nautical miles/160 kilometers
Maximum	101 nautical miles/185 kilometers
Speed	
Maximum speed	176 kilometers per hour/110 knots
Cruise speed	120 kilometers per hour/85 knots
Loiter speed	95 kilometers per hour/65 knots
Maximum endurance	95 kilometers per hour/65 knots
Propulsion Reciprocating Two-Stroke, Two-Cylinder	
Engine	26 horsepower
Fuel type	100-octane, low-lead aviation gasoline/2-stroke oil (50:1 ratio)
Weight	
Empty	125 kilograms/276 pounds
Fuel capacity	30 kilograms/65 pounds
Sensor payload (maximum)	34 kilograms/75 pounds
Maximum takeoff weight	189 kilograms/ 416 pounds
Dimensions	
Wing span	5.2 meters
Wing area	2.8 square meters
Avionics	
Power supply	28 volts direct current
Transponder	mode III identification friend or foe
Navigation	dead reckoning/global positioning system/ground track
Data Link	C-Band and UHF Tadiran/MKD-200/MKD-400 Versatron/DS-12
Sensors	visible light/infrared
Miscellaneous	
Deployment	shipboard—landing platform docks, land based
Launch and recovery	RATO/runway/pneumatic net/runway/hook
Operation	remote control or pre-programmed
Lightning protection system	yes
Releasable imagery	yes
Sensor imagery	C-Band
Command and control	C-Band/UHF

APPENDIX E. MAGTF IMAGERY INTELLIGENCE PLANNING CHECKLIST

This appendix identifies typical IMINT planning actions of the MAGTF G-2/S-2, its IMINT staff, other key G-2/S-2 intelligence staff officers, the intel

bn commander/intelligence support coordinator, the imagery intelligence platoon, and subordinate units' intelligence officers during each phase of the MCPP.

MCPD Step	Actions of MAGTF Staff	Actions of MAGTF G-2/S-2 and Intel Bn
Mission Analysis	<p>Identify the higher headquarters' (HHQ)/supported headquarters' intent.</p> <p>Identify tasks.</p> <p>Determine the AO and AOI.</p> <p>Review available assets and identify personnel and equipment resource shortfalls.</p> <p>Determine constraints and restraints.</p> <p>Determine recommended commander's critical information requirements (priority intelligence requirements, friendly force information requirements, essential elements of friendly information).</p> <p>Identify requests for information.</p> <p>Determine assumptions.</p> <p>Draft the mission statement.</p> <p>Present a mission analysis brief.</p> <p>Draft the warning order.</p> <p>Convene/alert red cell (if appropriate).</p> <p>Begin staff estimates.</p> <p>Refine the commander's intent.</p> <p>Develop the commander's planning guidance.</p>	<p>Review HHQ and MAGTF standing intelligence plans (e.g., Annex B to an OPLAN), pertinent memorandums of understanding, etc.</p> <p>Assist with determination of the MAGTF AO and AOI.</p> <p>Assess NIMA, combatant command's and other external organizations' imagery coverage of the AO and AOI.</p> <p>Provide digital imagery data and other IMINT products to support initial planning (ensure needs of subordinate commands are met).</p> <p>Determine specified, implied, and essential IMINT tasks.</p> <p>Begin development of proposed IMINT concepts of operation; obtain G/S-2 approval.</p> <p>Identify organic/supporting IMINT elements and imagery points of contact in all subordinate units; determine operational status of each; determine personnel and equipment deficiencies (special attention to data management, production, and distribution).</p> <p>Identify JTF/multinational imagery interoperability issues; provide recommendations.</p> <p>Establish/review/update the MAGTF IPL SOP and database; special attention to—</p> <ul style="list-style-type: none"> ● Identify imagery support requirements. ● Prepare imagery data profiles. ● Populate IPLs. ● Digitize relevant imagery and geospatial products. ● Identify external organizations' IMINT production plans and assess against MAGTF's initial requirements; determine deficiencies; initiate augmentation requests (coordinate with intelligence operations officer). ● Assign/task-organize organic IMINT elements. ● Validate/update JTF IMINT tactics, techniques, and procedures and MAGTF IMINT SOP (coordinate with HHQ and subordinate units). ● Validate and prioritize IMINT requirements; special attention to those needed for COA development. ● Begin development of IMINT operations plan; issue orders to IMINT production elements (coordinate with P&A cell). ● Determine initial IMINT CIS requirements and dissemination plan; identify deficiencies (coordinate with dissemination manager). ● Validate IMINT database management procedures (coordinate with JTF). ● Ensure subordinate units' IMINT POCs kept advised of actions and developments.

MCPP Step	Actions of MAGTF Staff	Actions of MAGTF G-2/S-2 and Intel Bn	
Course of Action (COA) Development	<p>Continue intelligence preparation of the battlespace (throughout all steps of the planning process).</p> <p>Array friendly forces.</p> <p>Assess relative combat power.</p> <p>Centers of gravity and critical vulnerabilities analysis.</p> <p>Brainstorm possibilities.</p> <p>Develop roughcut COA(s).</p> <p>Commander's input.</p> <p>COA(s) refinement.</p> <p>COA(s) validation.</p> <p>COA(s) graphic and narrative development.</p> <p>Prepare and present COA(s) briefing.</p> <p>Commander selects/modifies COA(s).</p>	<p>Assist with development and continued updating of the intelligence estimate.</p> <p>Develop an IMINT concept of operations for each COA; begin preparation of Appendix 7 (IMINT) and Tab C (UAV and other Aerial Reconnaissance Plans) to Appendix 14 (Recon and Surveillance Plan) to Annex B (Intelligence).</p> <p>Assist the intelligence section and other staff sections with COA development.</p> <p>Determine IMINT capabilities required for each COA.</p>	<p>Assist with the IMINT and related portions of Appendix 11 (Intelligence Estimate), Appendix 14 (Reconnaissance & Surveillance Plan), Appendix 16 (Intelligence Operations Plan), and Appendix 17 (Support to Survival, Evasion, Resistance, and Escape) to Annex B.</p> <p>Assist intelligence section with development of other portions of Annex B.</p> <p>Coordinate production of necessary IMINT products for each COA.</p> <p>Ensure subordinate units' IMINT POCs kept advised of pertinent actions and developments.</p>
COA Analysis	<p>Conduct COA analysis wargaming.</p> <p>Refine staff estimates and estimates of supportability.</p> <p>Develop concepts based upon warfighting functions (as required).</p> <p>Prepare COA analysis brief.</p>	<p>Complete IMINT estimates of supportability.</p> <p>Assist intelligence section with completing the intelligence estimate and the friendly intelligence estimate of supportability.</p> <p>Continue to monitor and update IMINT production operations.</p>	<p>Ensure subordinate units receive necessary IMINT products; verify understanding; identify/update subordinates current IMINT IRs.</p> <p>Validate and update IMINT information requirements.</p> <p>Ensure subordinate units' IMINT POCs kept advised of pertinent actions and developments.</p>
COA Comparison and Decision	<p>Evaluation of each COA.</p> <p>Comparison of COAs.</p> <p>Commander's decision.</p> <p>Issuance of warning order.</p>	<p>Assist intelligence section with evaluation and comparison of each COA.</p> <p>Continue development of Appendix 7 and Tab C to Appendix 14 to Annex B consistent with the selected COA.</p> <p>Continue providing IMINT assistance to appendices 11, 14, 16, and 17 to Annex B.</p> <p>Update, validate, and prioritize IMINT information and production requirements for the selected COA; issue orders as appropriate to IMINT elements.</p> <p>Coordinate IMINT element task-organization needs associated with the selected COA.</p> <p>Validate MAGTF IMINT IRs.</p>	<p>Continue coordination with the G-6/S-6 regarding IMINT CIS requirements; coordinate with G-1/S-1 as necessary for physical couriering of IMINT products to subordinate units.</p> <p>Continue coordination with the G-4/S-4 regarding IMINT supply and transportation requirements.</p> <p>Review actions associated with satisfying IMINT personnel and equipment deficiencies associated with the selected COA.</p> <p>Ensure subordinate units receive pertinent IMINT products; verify understanding; identify/update subordinates' current IMINT IRs.</p> <p>Ensure subordinate units' IMINT POCs kept advised of pertinent actions and developments.</p>
Orders Development	<p>Commander's intent is refined.</p> <p>Concept of operations turned into an operations order or a fragmentary order.</p> <p>Staff estimates and other planning documents are updated and converted into OPORD annexes and appendices.</p> <p>Commander approves OPORD.</p>	<p>Complete development of Appendix 7 and Tab C to Appendix 14 to Annex B; ensure copies provided to subordinate units and are understood.</p> <p>Provide final IMINT support required for Appendices 11, 14, 16, and 17 to Annex B.</p> <p>Update, validate, and prioritize IMINT information requirements and associated collection operations.</p> <p>Maintain coordination with external IMINT organizations.</p>	<p>Ensure pertinent IMINT products are disseminated to all subordinate units.</p> <p>Complete actions associated with personnel and equipment augmentation, interoperability issues, multinational dissemination, etc.</p> <p>Complete IMINT-related CIS, transportation, and supply actions.</p> <p>Monitor ongoing IMINT production operations; update and issue orders as appropriate to IMINT elements.</p>

MCPD Step	Actions of MAGTF Staff	Actions of MAGTF G-2/S-2 and Intel Bn	
Transition	Transition brief Drills Plan refinements (as required)	Assist intelligence section with transition brief. Modify IMINT plans as necessary. Monitor ongoing IMINT collection and production operations; update and issue orders as appropriate to IMINT elements.	Ensure all IMINT POCs in JTF, other components, and subordinate units fully understand plans and standing requirements, and ensure they have received necessary IMINT products. Participate in drills, as appropriate. Remain engaged in MAGTF future plans activities.

APPENDIX F. IMAGERY INTELLIGENCE REPORT FORMATS

Section I. Reconnaissance Exploitation Report (RECCEXREP)

PAGE 1 EXREP 15TH 102 CLASSIFICATION:_____ 831122 03346

UNCLASSIFIED EXERCISE NEVERLAND

MSG ID/RECCEEXREP/15TH/NO2222/3456

EFDT238442Z DEC 90

NARR: REF ITMOOS, LG ACTY NOTED THROUGHOUT TGT AREA

ITEM P6

ITM: 001 0380EX0000 CTY: MS 363219M1263214E

A. 52SDR46118324

B. 230422Z DEC 90

C. CAT: 06 Command Post.

1. Mobile Command Post.
2. Static, Camouflaged.
3. 10 T-62 Tanks, 3 M-1979 SP Guns, 5 UAZ69As, 5 LG Tents, 2 Spoon Rests, 50 PERS (count approx).
4. No defense noted.
5. Terrain is flat with little vegetation, approx 13 km SE of post, A AAA site was noted.

NO REPORT TO FOLLOW

D. 1. ACFT was fired upon AAA site.

2. 0081X.
3. Yes.

PAGE 1 EXREP 15TH 102 CLASSIFICATION:_____ 831122 03346

Section II. Initial Photo Interpretation Report (IPIR) and Supplemental Photo Interpretation Report (SUPIR) Format

PRECEDENCE

FROM: IIIC

TO: REQUESTOR

INFO:

REF: (a) As applicable.

(A) CLASSIFICATION

(B) SECTION 01 OF 01 SECTION

(C) IPIR: FIRST IIP SER: UVO157 PRJ: RD MSN: Z198A DTZ: 75022W

(D) IMAGE QUALITY RANGE WAS GOOD TO EXCELLENT. EIGHT OF TWELVE OF THE COLLECTION REQUIREMENTS WERE SATISFIED.

(E) PART I. MISSION HIGHLIGHTS

(F) NO EVIDENCE OF SURFACE-TO-SURFACE MISSILES OR RELATED ACTIVITY WAS NOTED. VEHICULAR AND TROOP MOVEMENT ACTIVITY IS VERY LIGHT. NO ANTI-AIR ACTIVITY OR REACTIONS TO THE RECONNAISSANCE PLATFORM WERE OBSERVED.

(G) PART II. SIGNIFICANT RESULTS

(H) A. PERISHABLE ITEMS

(I) ITMOOA: 0213-00000 CAT: 80000 AIRCRAFT IN FLIGHT

(J) REQ: CTY: LA211929N1061934E UTM: MRG:

(K) STA: TRM AI NRG:

(L) AOB:
0001 CONF PA-23 INFLIGHT HDG NORTHEAST

(M) IMR: PAN FRM: 1011, 1012 URG
AID: E AO CL BB FRM TOT: 1035Z

(H) B. NEW ITEMS

(I) ITM002: 0213UV0006 CAT: 87200 PURTEE SAM SITE

(J) REQ: CTY: LA210815N1055619E UTM: MRG:

(K) STA: UCO

- (L) DES: SA-O SITE IS BEING ESTABLISHED APROX ONE-HALF KM FROM THE RED RIVER. SITE CONSISTS OF SIX RVTD PSNS IN A STAR FORMATION. FULL DESCRIPTION NOT YET POSSIBLE. NO EQUIPMENT EXCEPT FOR CONSTRUCTION AND GROUND FORCE RELATED WAS IN THE AREA.

GFW:

0008 CONF DUMP TRUCK
0001 CONF ZAZ-7 CRANE
0001 PROB A-2 TRACTORURG:

- (O) IMR PAN FRM: 976-980 TOT: 1039Z
AID: G AO SC SH BB

(H) C. CHANGE AND OB ITEMS

- (I) ITM 0002: 0213-02351 CAT: 09100 WATERTON BARRACKS
AREA

- (J) REQ: 4A02316 CTY: LA221600N1053012E UTM: MTG:

- (K) STA: OPR AI NAC DQ B1236 750102 NRG: NDA04/0014/5

- (L) RMK: PREVIOUSLY REPORTED U/I ARMORED EQUIPMENT HAVE NOW BEEN IDENTIFIED AS SWG-99 TANKS.

GFW: AREA A-REGT A

0103 CONF SWG-99 TANK
0092 CONF DTR-12 TRUCK
0002 CONF MT-3 CRANE

GFW: AREA B-REGT AREA

GFW: AREA C-REGT AREA

GFW: AREA C-AAA BN

NAC DQ B1236 750102

NAC UP 298A 741209

NAC UP 208A 741209

- (M) IMR: PAN FRM: 500.490-516 URG: 234118
AID: G AO CL BB FRM: 135-138 TOT:1025Z
IDC: 221615N1053045E MPR:

(N) EQM

(O) PART III. OTHER RESULTS

(P) A. Mission Requirements

- (Q) Categorization of Target Entries. An introductory statement categorizing a set of like items to increase readability. DIAM 57-5 contains more detailed information on the structure of part III.

(R) PART IV. COLLECTION OBJECTIVES SATISFIED AND NOT SATISFIED

Explanatory Notes

1. () Shown for explanation only. Line identification is not shown on an actual message.
2. The IPIR/SUPIR/MIPIR format has been revised to accommodate the growth of automated intelligence systems. Detailed definitions and instructions for completing them are included in DIAM 57-05. However, as a user's guide to understanding the reports, the following definitions are provided.

Cable Line

Ref

(A) Self-explanatory

(B) Self-explanatory

(C) Report Type

Reporting Organization

Report Number

Reports will be numbered sequentially by the producing unit. A two-character alpha unit identifier as listed in DIAM 57-5 will be used followed by a four-digit sequential number.

Reconnaissance Project Identification

Two characters indicating the project of which this mission is part. This stands for mission independent. Project identifiers may be derived from DIA reconnaissance program directives or DIAM 57-5-1.

Mission Number

Date/Time Zone

(D) General Mission Statement

Free text reporting information applying to the entire mission such as graphic reference, sensors, sensor on/off times and coordinates, overall image quality, overall image scale range, other general mission data or any other information deemed useful. If the objectives of the mission and the requesting authority can be given (consider length and classification), these will be included. The general mission statement will be written as the interpreted mission and appropriate data will be reported.

(E) Part I. MISSION HIGHLIGHTS

Title for major division of the report.

(F) Textual Data for Mission Highlights.

Part I, Mission Highlights allows for a concise free text statement of the significant information derived from the mission. It may be used to highlight individual items reported

elsewhere in the message and to summarize information relative to a category of targets. Mission Highlights may also be utilized for summations of trends of individual categories such as logistics studies or combat information of a significant nature.

(G) Part II. SIGNIFICANT RESULTS

Title for second major division of the report.

(H) Categories of Items That May be Reported

A—Perishable Items. This section is for items of perishable intelligence value, including transitory targets.

B—New Items. This section is for items upon which the reporting organization has no previous image-derived data.

C—Change and OB Items. This section is for items that reflect significant changes since the last available interpretation and targets, which OB is required. For DOD combat reconnaissance programs, this section includes mission requirement objectives. A mission objective could also be reported under Perishable Items of Damage Assessment.

D—Bonus Items. This section includes significant changes to any known installation that is not a specified mission requirement objective.

E—Damage Assessment. This section is for the description of damage to targets from nonnuclear attacks. This section includes known strike objectives not damaged.

(I) Identification Data.

Item Number.

Basic Encyclopedia (BE) Number or Imagery Basic Encyclopedia Number.

Functional Classification Code. See DIAM 65-3-1.

Installation Name or Description of Object Imaged.

(J) Other Identification Data.

Requirement Number.

Country Code.

Geographic Coordinates.

Universal Transverse Mercator Coordinates.

Military District. Entered when applicable.

(K) Status/Activity Data

NEG. Negated (nonexistent). Target/installation does not exist at or near the coordinates given in the requirement.

UCO. Under Construction.

COM. Complete. The target/installation appears to be externally complete. Appears capable of operating but operational status cannot be determined.

UNK. Unknown. Status of the target cannot be determined.

MOP. Not Operational. Essential elements of a target/installation are observed not to be in operation; equipment essential to the operation of the installation is either missing or observed as not to be operational.

OPR. Operational.

OCC. Occupied.

DEC. Deception.

UNP. Unoccupied.

ABN. Abandoned.

RMV. Removed. Target/Installation has been razed, dismantled or moved.

TRN. Transitory. Fleeting targets or targets that appear to be only temporarily situated.

DMG. Damaged. Target is damaged to some extent, but it may be restored to usable condition.

DST. Destroyed. Target is so damaged that it cannot function as intended or be restored to usable condition.

CNA. Coverage not available.

Exploitation Level

AI -IPIR

AS-SUPIR

MI-MIPIR

Significance

The significance code indicates the interpreter's assessment of the degree of change in the installation status, capability or function since previous mission coverage. If a significance code is entered, the reference mission number and date will be entered. Codes are as follows:

NEW. Newly detected activity.

SIG. Significant change has occurred.

UNK. Significance of change is not known or change, if any, cannot be determined.

NAC. No apparent change.

Reference Graphic

When a national basic reference graphic, exists, the number may be required for certain specific programs. In all other cases, it will be left blank.

(L) Additional Interpretation Data

Additional photo interpretation data will be organized under one of the following codes.

DES. Physical description. A DES will be accomplished when an installation is covered for the first time, a basic description of the installation has not been previously written, the installation reflects a significant physical change, or first reporting an installation as abandoned or destroyed.

RMK. Remarks. This prefix will be used when providing less than a complete description of a known target and/or additional explanatory comments relating to status/activity.

Only a DES or RMK will be used for each entry, not both. If NAC is entered on the status line, a DES will not be used.

The remark will include the project code and mission numbers of the coverages used to prepare the report in those cases where more than one mission is used.

For multiple reporting (MIPIR), the actual OB count will be taken from a representative mission flown during the reporting period.

OOB Designations

MIS. Missile and missile related equipment.

AOB. Air OOB.

NVL. Naval and merchant vessels.

GFW. Ground force weapons and equipment.

ELC. Electronic OOB.

AAA. Antiaircraft OOB.

DMY. Dummy.

OBJ. Associated objects. Information relative to objects and equipment not reported under OOB entries.

Area Delineation

Refers to area delineation of the National Basic Reference Graphic or other descriptive location data. When Unpegs are not available, locational reporting is permitted (e.g., assembly area). Multicoverage dates may be included following each locational entry or as unique entries.

(M) Imagery Reference Data

IMR. Imagery Reference. A minimum of one IMR line is required; however, more lines may be required to indicate different coverage. For MIPIR, only those missions that contributed to a specific degree are entered on the IMR line. Initial information in the IMR line may include date of coverage, project code, mission number, and camera station. The following coded items may then be used.

IMR. Frame number.

SLR. Slide-looking radar.

INF. Thermal.

URG. Universal reference grid. Six position URG coordinates (see DIAM 57-23).

AID. Additional imagery data. AID is used to provide interpretability data. Interpretability codes are as follows:

E-Excellent

G-Good

F-Fair

P-Poor

Extent of Coverage and Mode

- A-Complete coverage/stereo
- B-Complete coverage/partial stereo
- C-Complete coverage/mono
- D-Partial coverage/stereo
- E-Partial coverage/partial stereo
- F-Partial coverage/mono

Type of Coverage

- O-Oblique
- V-Vertical

Weather Conditions

- CL-Clear
- SC-Scattered
- HC-Heavy Clouds
- HA-Haze

Other Conditions

- SN-Snow
- SH-Shadow
- OL-Degrading obliquity
- SD-Semidarkness
- BL-Blurred image
- TR-Terrain masking
- HD-Heavy smoke/dust

Type of Film

- B-Black and white
- C-Natural color
- G-Green record
- I-Color rear infrared
- R-Red record
- T-Thermal

S-Radar

N-Nonstandard

(Note: For stereo or partial stereo, two letters will be used, one for the first frame and one for the second frame; e.g., BB, black and white on both frames.)

FRM. Additional frame reference for a given target.

TOT. Time over target.

IDC. Imagery derived coordinates, derived from comparing imagery with a map or chart.

MPR. Map reference.

PPC. Precision photo derived coordinates.

- (O) Part III. OTHER RESULTS. Third major division of the report, as indicated by the sample; Part III may be omitted.
- (P) A. Mission Requirements. Provides for reporting items/targets not properly placed in Part II.
- (Q) Categorization of Target Entries. The format in part IV will contain collection objectives satisfied and not satisfied, plus a textual statement indicating any reasons for non satisfaction. Items contained in part IV can be understood from the codes listed earlier.
- (R) Part IV. COLLECTION OBJECTIVES SATISFIED AND NOT SATISFIED. Part IV of the format will contain collection objectives satisfied and not satisfied, plus a textual statement indicating any reasons for non satisfaction. Items contained in part IV can be understood from the codes listed earlier.

APPENDIX G. IMAGERY INTELLIGENCE SUPPORT TO INTELLIGENCE STUDIES

IPB is a systematic, continuous process of analyzing the threat and environment in a specific geographic area. It supports commander and staff estimates and decisionmaking. Applying the IPB process helps the commander selectively apply and maximize combat power at critical points in time and space on the battlefield. When taken in IPB's entirety, imagery plays a small and focused role. However, imagery's role is vital, especially in terrain analysis and mapping tasks.

IMINT Support to Drop Zone Studies

A drop zone (DZ) is a specific area where troops (e.g., a radio reconnaissance team), equipment or supplies are air-dropped. DZs are preplanned locations determined after careful consideration. IAs take on an important role and must consider the following DZ factors:

- Minimum DZ dimensions (DZ length/width computations).
- Maximum slope percentage for DZs is 30 percent.
- Surface and obstacle considerations.
- DZ accessibility and trafficability.
- Easy exit from the DZ.
- Type of aircraft employed.
- Altitude at which air delivery is to be made.
- Types of loads to be delivered.
- Availability of adequate aircraft approach and departure routes.
- Method of airdrop: free drop, high or low velocity.
- Potential approaches and exits.
- Proximity to mission objective.
- Enemy disposition.

- Alternate DZs and landing zones (LZs).
- Supporting fires (in coordination with the G-3/S-3 and the FSC).

DZ Length/Width Computations

The request for DZ identification and supporting intelligence will usually include the rate of speed the aircraft will fly over the proposed area and the amount of time required to deliver a load. The IA (or all-source intelligence analyst) must be informed of the prevailing wind velocity and wind direction, which have an impact on the aircraft's ground speed. When the wind velocity at the delivery altitude cannot be determined, use the aircraft's air speed as the ground speed. Use the steps outlined below to compute the DZ size.

Step 1. Compute the minimum required DZ length by multiplying the ground speed of the aircraft by the time needed to release its cargo.

Length computation formula: $L = R \times T$

L = DZ length (in meters)

S = Aircraft speed in knots

R = Ground speed of aircraft: $S \times .51$

$.51$ = Conversion factor of knots to meters per second

T = Time required for aircraft to release its cargo and personnel

Step 2. Compute ground speed R

$R = (S \pm \text{wind speed}) \times .51$

Add tail wind component of wind velocity to aircraft speed or subtract head wind component of wind velocity from aircraft speed (see figure G-1).

Convert knots to meters per second by multiplying aircraft speed by .51.

Step 3. Calculate DZ length (L) by multiplying R x T. The result is in meters. Always round up the required DZ length to the nearest meter.

EXAMPLE: If the aircraft speed is 110 knots, head wind is 20 knots, and drop time is 20 seconds, the required length of the DZ is:

$$L = R \times .51 \times T$$

$$L = (110 - 20) \times .51 \times 20 = 918 \text{ m}$$

Step 4. Compute required DZ width. The required DZ width depends upon the method and/or type of airdrop, wind drift, and formation of the aircraft, usually provided in the request. When it is not specified, you must give the requester the widths of all proposed DZs that also possess the required length. The wind drift formula is used to determine the minimum required width of a DZ. In this formula, K is a constant

that represents the characteristic drift of a certain model parachute. Always round up the required DZ width to the nearest meter.

$$\text{Wind drift formula: } D = K \times A \times V$$

$$D = \text{Width of DZ (in meters)}$$

$$K = 4.1 \text{ (constant) for personnel parachutes}$$

$$2.6 \text{ (constant) for all other parachutes}$$

$$V = \text{Velocity of surface wind (in knots)}$$

$$A = \text{Altitude of the aircraft (in hundreds of feet above ground level [AGL])}$$

EXAMPLE: An aircraft flying at 2,000 feet AGL is to drop a cargo load with wind speed of 11 knots.

$$D = K \times A \times V$$

$$K = 2.6 \text{ (G13 cargo parachutes)}$$

$$V = 11 \text{ knots}$$

$$A = (2,000 \text{ ft} / 100) = 20$$

$$D = 2.6 \times 11 \times 20 = 572 \text{ m}$$

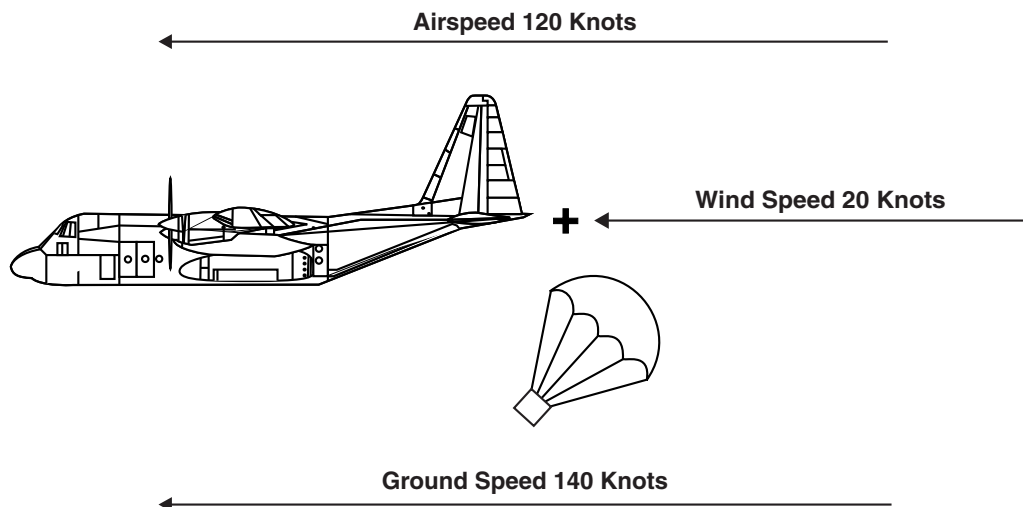

Figure G-1. Prevailing Wind Speed.

Step 5. Now that the required dimensions are known, the IA searches the imagery (or map if imagery is not available) for suitable DZs. Using a photo interpreter (PI) scale or equivalent scale, the IA measures the potential DZ length on the imagery and then computes the ground distance (GD) in meters. Always round down the potential DZ length to the nearest meter.

Imagery length computation formula:
 $GD = PD \times DPRF$

Map length computation formula:
 $GD = MD \times DMRF$

GD = Ground distance (length) in meters

PD = Photo distance (if in feet, then $\times .3048$ = Conversion factor of feet to meters)

DPRF = Denominator of the photo representative scale

MD = Map distance

DMRF = Denominator of the map representative scale

Scale = 1: DPRF or DMRF

EXAMPLE: An image has a scale of 1:25,000. Using your scale, you measure a potential DZ to be .06 foot.

PD = .06 ft

DPRF = 25,000

GD = $.06 \text{ ft} \times 25,000 \times .3048 = 457.2 \text{ m} = 457 \text{ m}$

Step 6. The IA now measures the potential DZ width on the imagery (or map if imagery is not available) and then computes the ground distance in meters the same as in step 5 above. Always round down the potential DZ width to the nearest meter.

EXAMPLE: An image has a scale of 1:25,000. Using your scale you measure a potential DZ to be .04 foot.

PD = .04 ft

DPRF = 25,000

.3048 = Conversion factor of feet to meters

GD = $.04 \text{ ft} \times 25,000 \times .3048 = 304.8 \text{ m} = 304 \text{ m}$

Step 7. In those cases where the plot of the potential DZ is irregular in shape, the lengths and widths will be determined as shown in the sketch in figure G-2. The usable length is measured along a centerline while width used is the minimum dimension of the plotted areas with ends perpendicular to the centerline. Width is 140 meters in this example and length is 380 meters.

Step 8. Compute flight time. For safety requirements, a DZ should be as large or larger than the commander's request. Normally an area 460 meters long and 180 meters wide is the minimum requirement for the delivery of supplies. If a DZ of the desired length is not available, the flight time over the DZ (whatever its length) must be computed to determine how much of the load can be released in

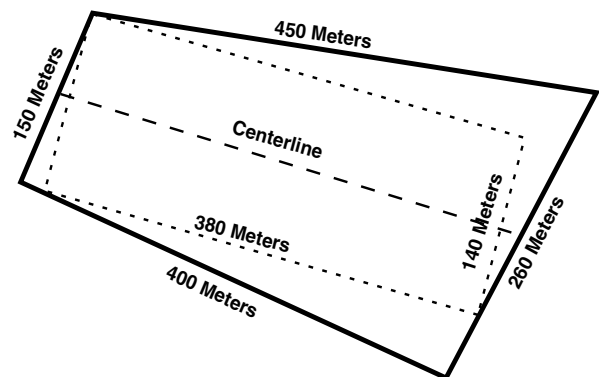

Figure G-2. Irregular-Shaped DZ.

one pass and/or how many passes must be made to release the entire load. Always round the flight time down to the next lower whole second.

$$\text{Flight time computation formula: } T = \frac{L}{R \times .51}$$

T = Time over the DZ in seconds

L = Length of the DZ in meters

R = Aircraft ground speed in knots

.51 = Conversion factor of knots to meters per second

EXAMPLE: An aircraft is flying at 105 knots over a DZ that measures 150 meters long.

L = 150 m

R = 105 knots \times .51 = 53.55 = 53 m/seconds

$$T = \frac{150}{(105 \times .51)} = \frac{150}{53} = 2.83 = 2 \text{ seconds}$$

Slope Calculations

After the DZ area has been determined, the IA computes the slope. For this task a map of the area is required. The slope of a DZ should not be more than 30 percent. Always round up the slope to the nearest percent. Both vertical distance (VD) and horizontal distance (HD) must use the same unit of measurement (feet or meters). Use 3.281 as the conversion factor from meters to feet or .3048 to convert feet to meters. Use the following formula to compute the terrain's slope, which will be expressed as a percentage:

$$SL = \frac{VD}{HD} \times 100$$

SL = Percent of slope

VD = Vertical distance of the DZ (altitude difference between each end of the DZ length)

HD = Horizontal distance of the DZ

100 = Conversion factor for percent

EXAMPLE: The length of the DZ is 900 meters, one end is at an altitude of 150 feet and the other end at 200 feet, the percent of slope is 1.7%, rounded up to 2%.

$$SL = \frac{(200 - 150)}{(900 \times 3.281)} \times 100 = 1.7\% = 2\%$$

The contour intervals on maps are in feet or meters. The bar scales are usually in meters, yards, statute miles or nautical miles. If the bar scale is used, a conversion from one unit of measure to another may have to be performed. If a PI scale is used, be sure to multiply the measurements by the map scale. To determine slope using a map, refer to the following steps and figure G-3 on page G-5 and figure G-4 on page G-6.

Step 1. Determine the elevation of each point. Neither point is on a contour line, so it will be necessary to interpolate. Point Y is located on an intermittent stream symbol, confused with a contour line if care is not taken. The contour interval is 50 feet.

Step 2. Measure the distance between points X and Y using a piece of paper, PI scale or boxwood scale. Make measurements from the center of one dot to the center of the other dot (see figure G-4 on page G-6). A tube magnifier may be required to exactly align the scale with the centers of the two points to accurately determine the distance found.

In figure G-4 on page G-6, the map distance (MD) is 2.95 centimeters (cm). GD is found by solving the following formula:

$$GD = MD \times \text{DMRF, the latter of which is } 50,000$$

$$GD = 2.95 \text{ cm} \times 50,000 = 147,500 \text{ cm} = 1,475 \text{ m}$$

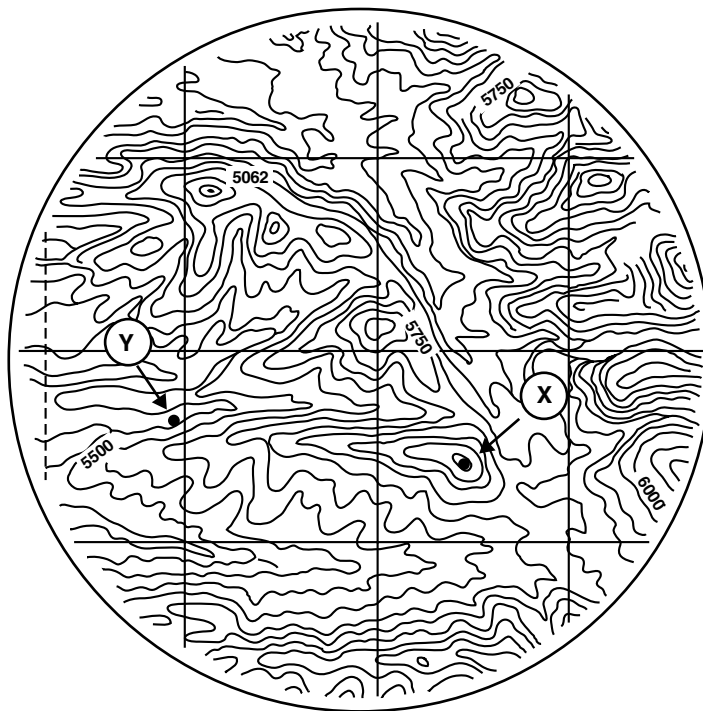

Figure G-3. Map Extract (map not to scale).

In comparing elevations and horizontal distance, elevation is in feet and distance in meters, so a conversion from one to the other is required.

$$GD = 1,475 \text{ m} \times 3.281 \text{ ft/m} = 4,839.475 \text{ (rounded up to 4,840 ft)}$$

Step 3. Use the slope formula:

VD = change in elevation from point V to point Y

$$SL = \frac{VD}{HD} \times 100 = \frac{XY}{HD} \times 100$$

EXAMPLE: A DZ with a length of 4,840 feet has elevations of 5,925 feet and 5,475 feet.

$$SL = \frac{5,925 \text{ ft} - 5,475 \text{ ft}}{4,840 \text{ ft}} \times 100$$

$$SL = \frac{450}{4,840} \times 100 = 9.2975; \text{ rounded up to } 10\%$$

$$SL = 10\%$$

Surface and Obstacle Considerations

When both size and slope of a proposed DZ are acceptable, inspect imagery of the area for the presence of obstacles and potentially hazardous surface conditions. This requires examination of photography in stereoscopic pairs as well as a review of available maps. Two major reasons for the examination of imagery are to protect troops from injury during a drop and to prevent the unsuccessful drop of equipment. The most acceptable DZ is a flat, resilient surface without obstructions.

Unfavorable or hazardous surface conditions are normally provided by the terrain detachment, to include information on—

- Water.
- Marshland.
- Gullies.
- Drop-offs (cliffs).
- Dense trees.
- Dense low vegetation.
- Large rocks.

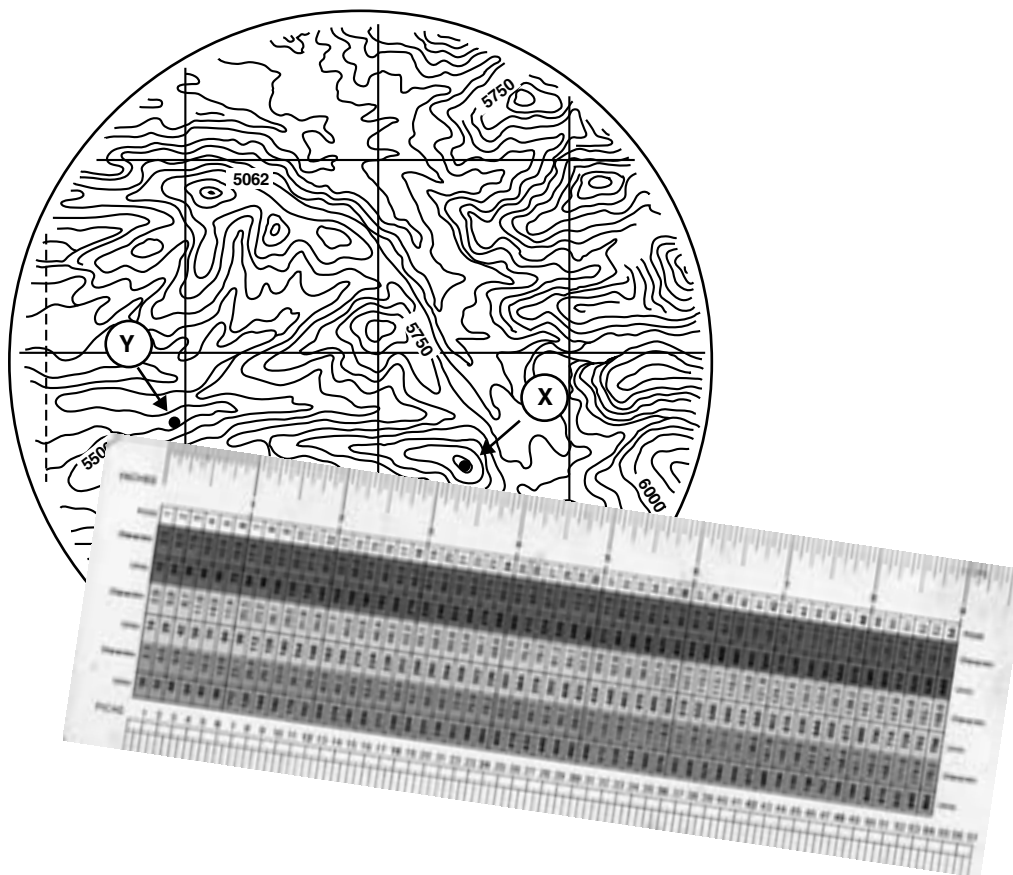

Figure G-4. Measuring from Dot to Dot (map not to scale).

Obstacles that are manmade features, such as—

- Power lines and poles.
- Buildings.
- Towers.
- Fences.
- Military impediments (e.g., stakes, barriers, barbed wire).

DZ Accessibility and Trafficability

A favorable DZ must have easy accessibility for both approach and exit. If possible, DZs near LOCs should be selected.

Certain questions must be answered before identification can occur; the tactical situation will add other questions:

- Will the approach involve more or less troops and equipment than the exit?

- Will the exit involve more or less troops and equipment than the approach?
- Will the approach or exit occur during daylight or night?

When troops are parachuted into a DZ, it is important they have an easy exit. The exit should be in the general direction supporting the ground tactical plan. When supplies or equipment comprise the load, personnel on the ground must be able to approach the area, recover the material, and then exit with the material. When evaluating a potential DZ for accessibility, the type of load will be a major consideration.

EXAMPLE: If wheeled vehicles are parachuted into a DZ, troops on the ground may be able to approach the DZ through a densely wooded area or up a steep slope. However, the vehicles may not be able to exit through the forest or negotiate the slope.

Related to accessibility is the trafficability of the soil. Swampy soil, or in some cases fine sand, may rule out the selection of a DZ. The parachuted equipment may bog down or troops may not be able to approach or exit the area rapidly. Therefore, trafficability of access routes must be considered to afford easy cross-country movement of vehicles and personnel in and out of the DZ.

DZ Reports and Overlays

Normally, the IA assists all-source intelligence and geographic intelligence (GEOINT) analysts with preparing a report in accordance with local SOPs. A primary DZ and alternate DZs will be selected that meet the specified intelligence requirements. This information is provided to the P&A cell OIC, who in turn recommends these to the ISC and G-2. Upon request, an overlay of the primary and alternate DZs will be prepared. GEOINT analysts generally will prepare this overlay.

IMINT Support to Helicopter Landing Zones Studies

A helicopter landing zone (HLZ) is a specified ground area for landing assault helicopters to embark or disembark troops and/or cargo. An LZ may contain one or more landing sites. Primary and alternate HLZs that meet the IRs will be identified, analyzed, and provided to the supported ground unit and aviation commanders. The ground unit commander (or helicopter unit commander) in coordination with the supporting air mission commander (AMC) will select the final location of the HLZ to best support the ground tactical plan.

General HLZ Criteria

In selecting an HLZ from maps, aerial photographs, and actual ground or aerial reconnaissance, the same criteria used for determining a DZ apply. Additional information, normally supplied by the ACE commander or AMC, should be used when selecting an HLZ. Information

should include the type of HLZ and type and the number of helicopters used. HLZs have the following specifications:

- An HLZ is a helicopter landing area that encompasses one or more helicopter landing sites.
- A helicopter landing site is a subdivision of an HLZ. The size of a landing site depends on the number of landing points (LPs) and the size of the LPs.
- An LP is a designated or selected touchdown point where a single helicopter lands.

As previously stated, the size of the landing site will depend on the number of LPs within it, and the size of these LPs. As a guide, a helicopter requires a relatively level, cleared, circular area of 20 to 75 meters in diameter, depending on the type of helicopter. A helicopter requires more usable landing area at night than during the day. The criteria provided in figures G-5 on page G-8, G-6 on page G-8, and G-7 on page G-9, represent guidance on LP preparation. Helicopter units will designate the size (small, medium or large) to be used by their units for specific operations. Numerous considerations such as helicopter type, unit proficiency, nature of loads, and weather conditions may apply to size of LPs used. General distances between LPs within a landing site in daytime landing are as follows (measured center to center):

- Small landing points 80 feet, or 25 meters.
- Medium landing points 115 feet, or 35 meters.
- Large landing points 165 feet, or 50 meters.

Most helicopters cannot land or take off vertically when they are fully loaded; therefore, a larger area or a better approach is needed.

The ACE commander has the final authority in establishing the landing area criteria for assigned helicopters in daytime and nighttime missions. This may change from time to time, depending on how heavily loaded the aircraft will be, the place and time of landing, and the anticipated weather conditions. During specific missions, the

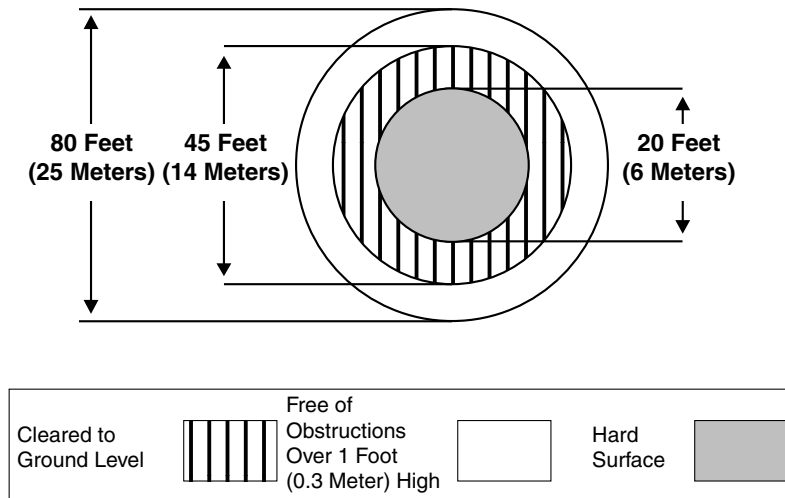

Figure G-5. Small Landing Point Dimensions.

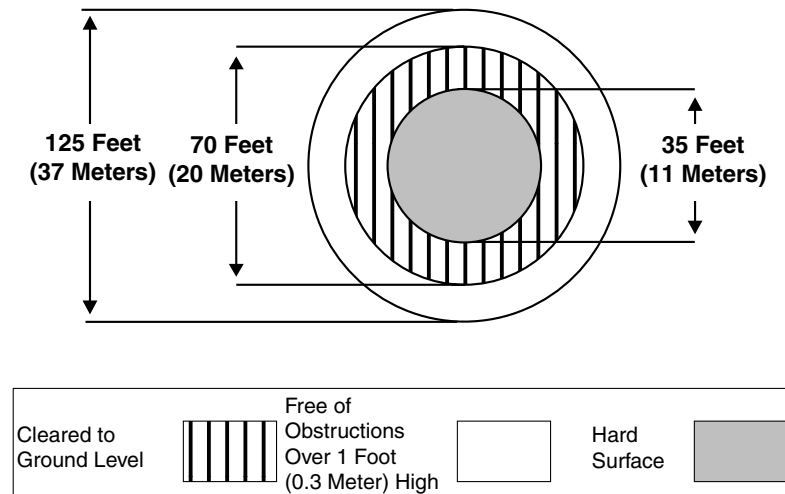

Figure G-6. Medium Landing Point Dimensions.

AMC may exercise this authority. For example, the area requirement may be larger when—

- A helicopter is heavily loaded.
- Helicopter cargo is sling loaded.
- Landing must be made at night or during other periods of reduced visibility.
- There are terrain obstructions or obstacles in the area.
- An area is located at high elevation.
- Temperature is hot or when humidity is high.

The ACE commander or AMC should provide the G-2 or ISC with required dimensions for all HLZs based on various flight and landing formations. This action will assist the IA and all-source intelligence analyst in locating potential HLZs.

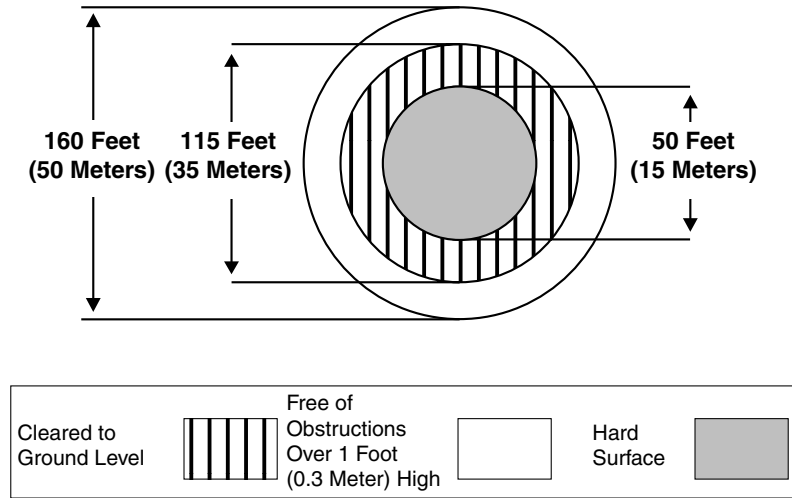

Figure G-7. Large Landing Point Dimensions.

HLZ Computations

In determining the HLZ area size, proceed in the same manner as for the DZ area. First, compute the required and then the potential HLZ areas. To determine the HLZ area, use the procedures shown below.

Step 1. Determine HLZ dimensions on photographs or maps. If the results are in fractions, round down to the nearest foot or meter. Use the same basis for all measurements (either feet or meters). FORMULA:

Potential HLZ length when measuring:

- Imagery: $GD = PD \times DPRF$
- On a map: $GD = MD \times DMRF$

Potential HLZ width when measuring:

- Imagery: $GD = PD \times DPRF$
- On a map: $GD = MD \times DMRF$

Step 2. Determine how many helicopters can land in the potential HLZ area in a two-trail formation during the daytime. Round up converted LP dimensions.

Step 3. Determine the number of LPs (or helicopters) from front to rear of the potential HLZ. Round down number of helicopters. FORMULA:

$$\text{LPs from front to rear} = \frac{\text{Potential HLZ length}}{\text{Minimum recommended LP length}}$$

Step 4. Determine number of lateral LPs of the potential HLZ. FORMULA:

$$\# \text{ Lateral LPs} = \frac{\text{Potential HLZ width}}{\text{Minimum recommended LP width}}$$

Step 5. Determine the total number of helicopter LPs of the potential HLZ. FORMULA:

$$\text{Total \# helicopter LPs} = \# \text{ of LPs from front to rear} \times \# \text{ of lateral LPs}$$

Slope Computations

The slope for an HLZ should not exceed 8 percent if the helicopter is to land. However, at the pilot’s discretion it may be possible for a helicopter to hover just in contact with the ground on slopes greater than 8 percent.

When you compute the slope, do not depend entirely on the map. Study the area on imagery, too.

The map contour intervals may indicate that the percent of slope is sufficient, but sloping or rugged terrain can be seen only with a stereoscope.

When the slope is greater than the allowable 8 percent, report this to the requester. The site may still be usable if the commander chooses to hover the aircraft and load/unload troops and supplies by rope or ladder. When the slope is more than 8 percent, provide the requester with the exact percent figure so he can assess alternatives and decide. This is important because when the ground slope is less than 8 percent, helicopters should be landed up-slope. When the slope is more than 8 percent, helicopters should land side-slope. See figure G-8.

Now you are ready to compute the slope of each potential HLZ. Do this the same way as the DZs using the formula:

$$SL = \frac{VD}{HD} \times 100$$

When you compute the HLZ slope, consider the following:

- Direction of positive slope. This is important for the approach and exit direction.
- Number of aircraft used. The AMC will provide this information.
- The density altitude. The altitude, temperature, and humidity determine the density altitude (DA). For planning purposes, as DA increases, the landing area should increase proportionately.

- Approach/departure directions. When possible, approach and departure should be into the wind. However, if there is only one suitable approach direction due to obstacles, the tactical situation, or if it is desired to make maximum use of the available HLZ, most helicopters can land with a crosswind (10 knots or less) or a tailwind (5 knots or less). The same applies to departures from the HLZ.
- Loads. When fully loaded, most helicopters cannot ascend or descend vertically.

Aircraft Landing Zone

An aircraft LZ (also referred to as runway or landing strip) is a specified location used for landing aircraft. Potential aircraft landing zones are selected to meet the intelligence requirements of the supported ground and aviation units' commanders. Potential aircraft LZ locations will be identified and analyzed based on aerial imagery, current maps, and other available intelligence.

Aircraft Landing Zone Criteria

An aircraft LZ is established so aircraft can safely land and take off. It also provides guidance for aircraft while they are taxiing and parking. It has one or more landing strips. The landing strip consists of a runway and may include taxiways, parking points, and dispersal areas. Selection of a potential aircraft LZ depends on the type aircraft, runway dimension requirements (see table G-1), surface, and location.

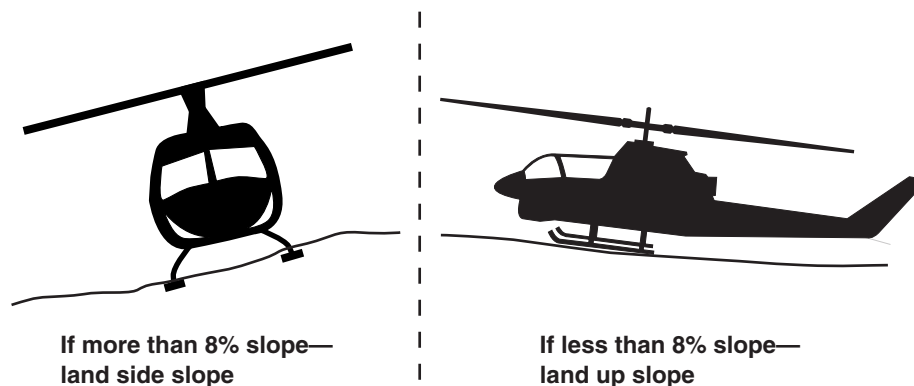

Figure G-8. Helicopter Landing on Side-Slope and Up-Slope.

Table G-1. Runway Dimension Requirements.

	Airfield Type	Runway Length (in feet)	Runway Width (in feet)	Runway Shoulder (in feet)
Forward Area	Attack & Utility	N/A	N/A	N/A
	Vertical	N/A	N/A	N/A
	Light Lift	1,200	60	10
	Medium Lift	2,500	80	10
Support Area	Attack & Utility	N/A	N/A	N/A
	Vertical Lift	N/A	N/A	N/A
	Light Lift	1,500	60	10
	Medium Lift	3,500	60	10
	Heavy Lift	6,000	100	10
	Tactical	5,000	60	4
Rear Area	Medium Lift	6,000	72	10
	Heavy Lift	10,000	156	10
	Tactical	8,000	108	20

Airfield Type

There are two types of aircraft landing zones, classified according to their size and degree of improvement:

A hasty landing strip has an unimproved surface, which normally is acceptable for marginal weather, but is unusable during prolonged poor weather. After a period of occupation, most pioneer landing strips (terrain permitting) can be improved to meet the requirements of a hasty landing strip. This strip has the following characteristics:

- Minimum length: 3,000 feet, plus a 10 percent overrun at each end.

- Minimum width: 50 feet, plus a 10 feet shoulder on each side.
- Minimum lateral clearance: 100 feet on each side of runway centerline.
- Has taxiways, parking areas, and may include dispersal areas.

A deliberate landing strip has an all-weather capability. As a minimum, it should have all the characteristics of a hasty landing strip, plus any other facilities needed to meet the standards required by any aircraft. A deliberate strip is usually a permanent installation with a control tower, hard surface runways, taxiways, and parking ramps.

Aircraft Landing Zone Computations

To determine the length and width of the area, use the same formula as for measuring a DZ or HLZ. Then identify the potential aircraft LZ by type.

EXAMPLE: If the photo scale is 1:20,000, the photo distance (length) is .08 feet and the photo distance (width) is .004 feet, then the potential aircraft LZ could be either a hasty or deliberate type depending on construction and facilities.

Slope Computations

In computing the slope (SL), the maximum slope for a potential aircraft LZ should not exceed 10 percent. Always round slope up to the nearest percent. Use the same formula as for computing SL of a DZ or HLZ:

$$SL \text{ (expressed as a percentage)} = \frac{VD}{HD} \times 100$$

Surface and Obstacle Considerations

The surface of a potential aircraft LZ must be firm and smooth enough to allow heavily loaded aircraft to land, taxi, park, and take off without delay or damage to the aircraft. It should be located away from obstacles such as mountains, telephone wires, tall buildings, and trees. The area should be free of heavy rocks and stumps so troops can clear it easily. This is particularly important for pioneer and hasty strips, which may have to be established quickly. The area should be dry, as water or marshland can cause early erosion.

LZ Accessibility

An aircraft LZ should have convenient access to and from the area, such as roadways or other level terrain. If there are prevailing winds, the runway should be oriented, if possible, so that aircraft can land and take off into the wind.

The minimum size of an aircraft LZ depends on the type of loads, the direction and velocity of winds, and the condition of the ground. Consider the following factors in establishing an aircraft LZ:

- Soft, wet, slippery or any other unfavorable surface conditions will increase the length of the aircraft LZ.
- Crosswinds may require an increase in width of the aircraft LZ.
- Uphill take off and downhill landings will require longer runways. The maximum slope on any aircraft LZ should not exceed 10 percent.
- Obstacle clearance is measured from the obstacle to the approach and departure end (if there are obstacles at the approach and departure ends of the aircraft LZ). Ensure a 10:1 clearance ratio is obtained (same as used for an HLZ).

Aircraft Landing Zones Overlays

Per the intelligence production requirement, all-source intelligence analysts, assisted by IAs and GEOINT analysts, will prepare an overlay of the potential primary aircraft landing zone and an alternate aircraft LZ if deemed necessary. A relief and drainage overlay may also be provided. Aircraft LZs are normally referred to by their nickname or a color. Situation and time permitting, GEOINT analysts will prepare this overlay.

IMINT Support to Beaches Studies

A beach is the area extending from the shoreline inland to a marked change in physiographic form or material or to the line of permanent vegetation. In amphibious operations, a beach is that portion of the shoreline designated for landing of a tactical organization. A landing beach is that portion of a shoreline usually required for the landing of a battalion landing team. However, it may also be that portion of a shoreline constituting a tactical

locality (such as the shore of a bay) over which a force larger or smaller than a battalion landing team may be landed. A beach landing site (BLS) is a geographic location selected for across-the-beach infiltration, exfiltration or resupply operations. A beachhead is a designated area on a hostile or potentially hostile shore that, when seized and held, ensures the continuous landing of troops and materiel, and provides maneuver space requisite for subsequent projected operations ashore. Finally, a landing area is the part of the objective area within which are conducted the landing operations of an amphibious force. It includes the beach, the approaches to the beach, the transport areas, the fire support areas, the air occupied by close supporting aircraft, and the land included in the advance inland to the initial objective.

Beach Landing Site Factors

A BLS is a continuous segment of coastline over which troops, equipment, and supplies can be landed by surface means.

Primary and alternate BLS are selected and prioritized after considering the commander's intent and guidance, concept of operations and scheme of maneuver, enemy disposition, size of the area required, terrain features, weather factors, supporting fire, and proximity of the objectives. Amphibious operations require a detailed study of hydrography, weather, climate, and terrain. The terrain portion is primarily the responsibility of MAGTF GEOINT analysts. A tactical study of the terrain is prepared by all-source intelligence analysts with major assistance from IAs and GEOINT analysts. (See MCWP 2-12, *Intelligence Production and Analysis*, and MCWP 2-12.1, *Geographic Intelligence*, for additional information on tactical studies of the terrain.)

The landing force commander selects specific landing beaches from available beach landing sites. When the amphibious task force is composed

of two or more attack groups with related landing groups, a landing area may be selected for each attack group. In this case, each landing group commander selects the landing beaches from within the assigned area.

The principal factors in the selection of landing beaches are—

- Suitability for beaching landing ships, landing craft, and amphibious vehicles.
- Beach trafficability.
- Suitability of offshore approaches.
- Number, location, and suitability of beach support areas and beach exits.
- Location, type, and density of beach obstacles, including underwater obstacles.
- Nature of the terrain immediately inland from the beaches.
- Suitability of LOCs, including roads, railroads, and waterways.
- Suitability of the beach from the standpoint of expected weather and tidal conditions.
- Known hostile force dispositions, strengths, and capabilities.

Beaches are categorized by their shape (see figure G-9 on page G-14):

- Concave (Point A to Point B).
- Convex (Point B to Point C).
- Straight (Point C to Point D).
- Irregular (Point A to Point D).

Beach types include the following:

- Coastal plain.
- Coastal ridge.
- Cliff or terrace.
- Coral reef.
- Glacial.
- River mouth or delta.
- Pocket.

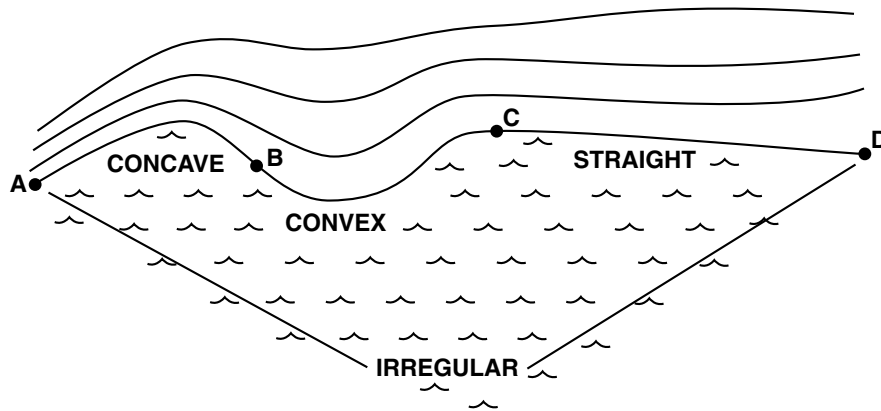

Figure G-9. Beach Categories.

Coastal Plain Beaches

A landing on a wide coastal plain beach provides unrestricted maneuver room, and a subsequent advance from the beach can be made in any direction. Boundaries and objectives are more difficult to locate on this type of terrain; there are few prominent registration points for artillery, naval gunfire, and aerial bombardment. Usually there is no natural defensive terrain on the flanks of the beachhead, so more troops are required to protect the flanks. Some coastal plain beaches are near marshy and swampy terrain, which may hinder movement from the beach.

Coastal Ridge Beach

A coastal ridge beach has terrain that rises evenly to a considerable distance back from the beach that gives the defender excellent observation and fields of fire. More commonly, the coastal area remains flat for some distance and then rises in a steep gradient to a coastal ridge.

Cliff or Terrace Beach

A cliff or terrace beach is usually quite narrow. The delineation of a cliff beach from a terrace beach basically is established by the height of the landmass immediately behind the beach. Cliff

beaches may have rocks and debris that accumulate by erosion of the adjoining severe terrain. The surface is made up of the same type of material as the major adjacent landform. If wave action is strong on a cliff beach, any fine material is washed away resulting in a beach covered with boulders or barren rock. Cliff beaches isolated from strong wave action are usually composed of sand and similar to coastal plain beaches as far as surface materials are concerned. A terrace beach may be composed of loose sand or rocks; it may be barren rock or strewn with boulders.

Coral Reef Beach

A coral reef beach is located in the coral region (normally between 30 degrees north latitude and 30 degrees south latitude) protected by a barrier reef with fringing reef along the shoreline, or it is located on an atoll. Any beach protected by a barrier reef is composed primarily of fine coral sand (coral skeletal remains, broken shells, and hardened algae) and is usually firm and narrow. When the beach or fringing reef is exposed to wave action, the foreshore is eroded. The coral reefs themselves normally present significant obstacles with abrupt seaward slope and the exposed offshore edge of the reef is steep. The upper surface of the reef may be extremely rough with

jagged coral formations rising above the surface and deep pits indenting the surface of the reef. An atoll is a ring-shaped coral island or group of coral islands enclosing a lagoon or another island. It has the same basic characteristics as the coral barrier reef.

Glacial Beaches

Glacial beaches are usually found in the higher latitudes, normally above 60 degrees north and 60 degrees south latitude. These beaches were eroded by glacial action and have round and irregular shorelines with numerous inlets; some may be quite deep, long, and narrow, with almost perpendicular, smooth mountain walls rising to great heights. This type of coast is very dangerous to navigation because of the islands and rocks off entrances to the inlets. The beach may be composed of material that has no geologic relationship to the coastline with depositions of material carried from the hinterland by the glaciers. This is often a mixture of silt, sand, gravel, and rocks.

River Mouth or Delta Beach

This type beach is easy to identify due to its proximity to the mouth of a major stream or river. It undergoes a greater physical change than the other beach types, and the foreshore is composed primarily of the type of sediment carried by the stream or river.

Pocket Beach

A pocket beach is found on many of the coasts throughout the world and has a wide range of composition and topography. The irregular coastlines, where pocket beaches are quite common, are made up of headlands and indentations with the pocket beaches found in the indentations. This type of beach is divided into two general areas: the end zones and central zone.

- The end zones are those areas on the flanks inside the beach termination points. They are protected from direct wave action by the headlands and subsequently the beach soil is usually fine sand.
- The central zone is that portion of the entire beach between the end zones and exhibits the same characteristics and soil conditions of any beach exposed to wave action. Any highlands behind the beach may provide the source material continually washed down and deposited on the beach. Lowlands behind the beach, however, will have little effect on its character.

A common problem affecting some pocket beaches is that many of the bays or other indentations fronting the beach may become blocked by sandbars built up by sand drifting along the coast in long shore currents. These sandbars may become attached to the mainland at the upstream end, and any open channel that might exist will occur at the downstream end. Sometimes these sandbars connect offshore islands to the mainland. Pocket beaches are usually concave shaped.

Beach Landing Site Criteria

The required beach area for amphibious operations is calculated based on original requester's guidance, type forces conducting the ship-to-shore maneuver, local SOPs and METT-T.

To identify whether an area is suitable for beach landings, intelligence analysts will require the following information:

- Minimum length of beachfront necessary.
- Types of equipment being landed.
- Types of transports to be used, to include length and width of each transport type.
- Transport capability. (Can it land on the beach? What minimum depth [draft] is required?)

Beach Landing Site Computations

Beach landing length is computed using the formula $GD = PD \times DPRF$ similarly as for DZs, HLZs, and aircraft LZs. Measurements are taken from one termination point to another (see figure G-10) and rounded down to the nearest meter.

- The beach termination points are the extreme ends of the beach selected. The total length of the beach is measured between these points following the natural coastline.
- The beach width is the horizontal dimensions of the beach measured at right angles to the shoreline from the line of extreme low water inland to the landward limit of the beach (the coastline). It usually will not be uniform and, therefore, is determined at various points along the beach.
- The beachhead line, roughly semicircular, encompasses that area near the coast large enough for the deployment of the assault force and its supplies and equipment, and usually includes terrain

features that are the initial objectives of the assault force. The beachhead line, if established, must be held so the subsequent landing forces can land and deploy in proper battle order. Loss of or major enemy force penetration into the beachhead line places the entire amphibious operation in jeopardy.

- The beachfront extends from low tide limit to the high tide limit and usually coincides with the foreshore (see figure G-11).

Percent of Slope and Gradient Computations

Use the same formula as for determining percent of slope of a DZ, HLZ or aircraft LZ with different specifications. Measurements are made of the width of the beachfront. Always round up percent of slope to the nearest percent.

$$SL = \frac{VD}{HD} \times 100$$

$$SL = \text{Percent of slope}$$

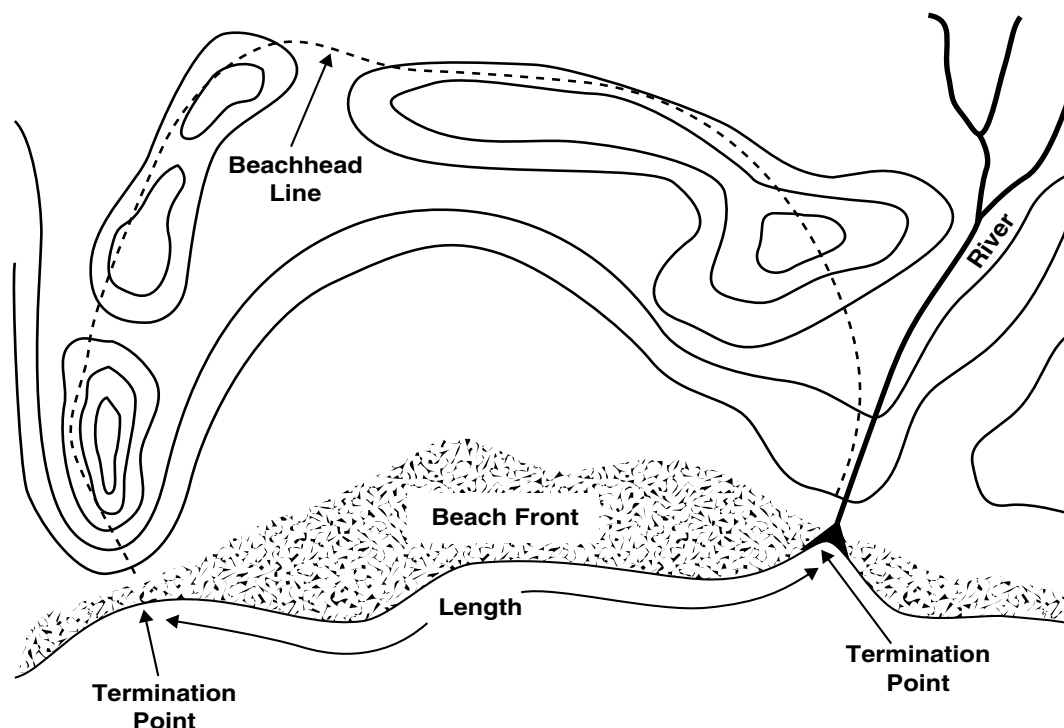

Figure G-10. Landing Beach Length.

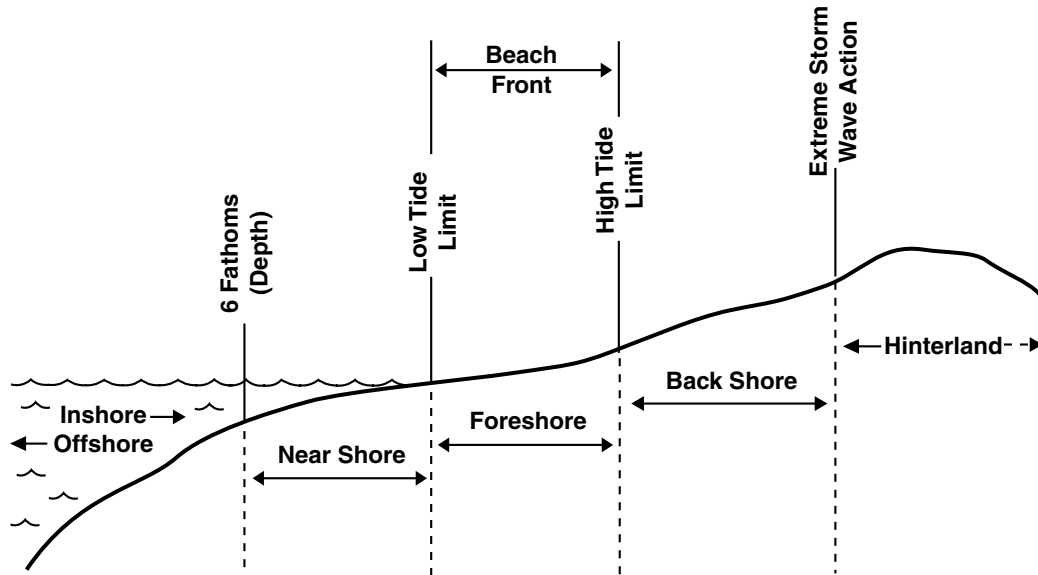

Figure G-11. Shores.

VD = The height difference of the beachfront, which is from the edge of the beachfront (low tide limit) to the high tide limit.

HD = The horizontal (ground) distance of the beachfront.

Combined offshore or foreshore/back shore beach gradient is expressed as a ratio of the rise in elevation of one unit of measure to the horizontal (ground) distance in a number of the same unit of measure; e.g., 1:15.

FORMULA:

$$\text{Gradient} = \frac{\text{VD}}{\text{HD}}$$

A quick way to obtain the gradient (1:) is to invert the fraction and divide the denominator by the numerator. Round up any fractions to the next whole number (e.g., 1:50.52 = 1:51).

EXAMPLE: If VD = 150 m and HD = 3,000 m

$$\text{Gradient} = 1: \frac{3,000}{150} = 1:20$$

In computing the combined foreshore/back shore gradient, measure from the shoreline to the nearest 20 meter contour line used for the start of the hinterland. You should transfer the 20 meter contour line from the map to the photograph by interpolation prior to making your measurement. The gradient is further expressed as shown in table G-2.

Table G-2. Beach Gradients.

Less than 1:120	Flat
1:120 to 1:60	Mild
1:59 to 1:30	Gentle
1:29 to 1:15	Moderate
1:14 or more	Steep

The depth lines or curves illustrated at 1, 2, and 3 fathoms (1 fathom = 6 feet) (see figure G-12 on page G-18) are established to determine the offshore gradient and to assist in the safe approach of the landing craft. The depth curves may be a series of dots (as shown) or solid lines.

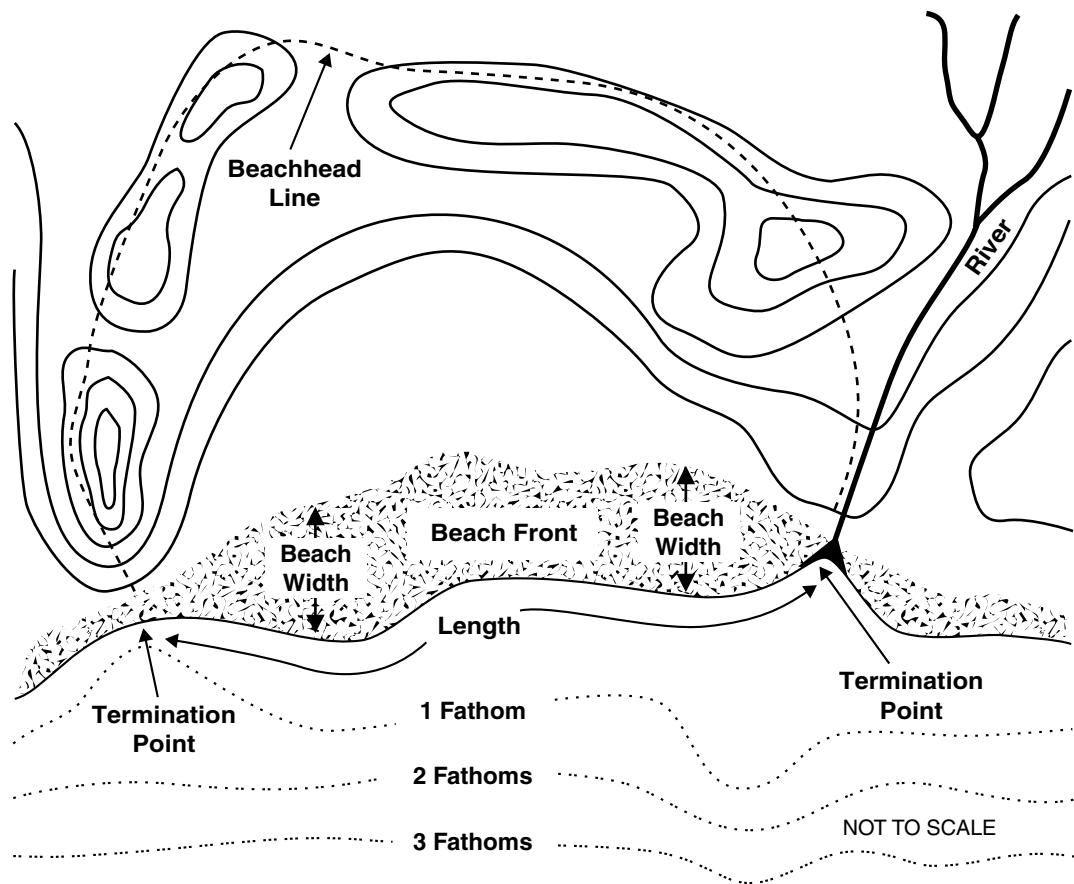

Figure G-12. Typical Beach Landing Area.

Surface and Obstacle Considerations

Normally, the surface condition of the combined foreshore and back shore areas is considered critical upon landing. The foreshore is generally white; the back shore begins where the beach discoloration changes from white to brownish gray and ends at the beginning of the hinterland by revealing a darker tone and taller vegetation on aerial photography.

Unfavorable or hazardous surface conditions include—

- Large rocks or reefs.
- Drop-offs (cliffs).
- Dense trees.
- Dense vegetation.

Obstacles include—

- Buildings.
- Military impediments (e.g., landing craft barriers, barbed wire).

BLS Accessibility

Because of the configuration of shorelines, usually the area most suitable for the execution of a landing operation is also the most easily organized for defense. The ideal beach for amphibious landing is one with—

- No obstructions in the sea approaches.
- Deep-water close inshore.
- Near shore gradients sufficiently deep for dry-ramp beaching of landing craft and ships.

- Soil composed of firm sand with gentle gradients or slopes.
- Small tides.
- No currents.
- No surfs.

The beach terrain should be—

- Gently rising, relatively clear, and with a firm surface that has adequate drainage.
- Flat or gently rising terrain, backed by a coastal range high enough to mask the landing area.

Ideal conditions are rarely found, so suitable areas must be evaluated to determine those that come nearest to optimum requirements. Other terrain considerations include:

- **Dunes.** Ground that is sharply broken by extensive dunes or a low coastal plateau provides the attacker with concealment from the defender's observation. The small compartments and corridors limit the range of defensive fire.
 - Transverse dunes are mounds of sand with their longest dimensions oriented at right angles to the prevailing wind. They usually have a steeper leeward slope than they have on the windward side.
 - Longitudinal dunes are sand formations whose longest dimensions are oriented in the same direction as the prevailing wind. They may have a symmetrical shape or may be without any particular shape at all. Longitudinal dunes may be over 100 miles in length. They are usually not backed by areas of standing water, such as swamps or marshes.
 - Because they are formed by windblown sand, coastal dunes are quite unstable landforms, appearing in one location as a transverse dune, only to disappear and reform as a longitudinal dune elsewhere. The winds responsible for their formation may also be the means for their destruction.
- **Mountains.** Mountains located directly on the sea usually limit the number of beaches large

enough to accommodate a landing force of effective size. Where steep ground is lightly defended or neglected by the defender, a small force may seize it and gain surprise. Airborne or airmobile troops may be used to block the movement of defensive reserves to the landing area or to secure passes through the mountains and thus prevent the defender from interfering with the amphibious landing.

- **Sandbars.** These offshore sand formations are usually found near coastlines with a gentle beach gradient. During stormy weather the sandbars will be found further offshore than during calmer weather conditions. Sandbars paralleling the coast may cause a lagoon to form between themselves and the coastline; direct access to the shore is dependent on openings (channels) through the sandbar areas. The locations of these channels are highly variable, and current photography is required before the actual landing takes place. Soil analysis, beach materials, and other trafficability aspects are normally reported by terrain and soil analysts. However, IAs will determine beach exits (roads, airstrips, etc.).

Beach Landing Site Collection Checklist Preparation

A collection checklist must be prepared for each potential BLS using the following items:

- Identification. Local name and military designation.
- Location
 - Map reference—include series and sheet number(s) of both tactical and air/ground series.
 - Political unit, area, universal transverse mercator (UTM) coordinates, and geographic coordinates of the termination points.
 - Landmark reference—description and location of the landmark and azimuth and distance from landmark to termination point.
- Related water body or watercourses. Cross-reference to appropriate collection file.

- Length between termination points. Self-explanatory.
- Seashore form. Concave, convex, straight or irregular.
- Coastal terrain type. Emergent, submergent, compound, coral reef, delta, volcanic, fault, manmade, and so on.
- Alignment. High-water shoreline and low-water shoreline.
- Beach width at low water. Self-explanatory.
- Beach width at high water. Self-explanatory.
- Backshore
 - Slope.
 - Material (composition, texture, trafficability).
 - Obstacles.
 - Vegetation.
- Foreshore
 - Slope.
 - Material (composition, texture, and trafficability).
 - Obstacles.
 - Vegetation.
- Near shore. (Give alignment and distance from low water shoreline).
 - 10 m (5 fathoms) depth line at low water.
 - 6 m (3 fathoms) depth line at low water.
 - 4 m (2 fathoms) depth line at low water.
 - 2 m (1 fathom) depth line at low water.
 - Obstacles.
 - Reefs (near shore):
 - Type and location.
 - Distance from low water shoreline.
 - Length and width.
 - Slope (direction).
 - Depth to surface of reef at low tide.
 - Depth to surface of reef at high tide.
 - Height of surface above water at high and low tide.
 - Effects of surf.
 - Effects on tide.
 - Channel through reef (alignment, width, and depth at low water).
 - Reefs (offshore):
 - Type and location.
 - Distance from low water shoreline.
 - Length and width.
 - Slope (direction).
 - Depth to surface of reef at low tide.
 - Depth to surface of reef at high tide.
 - Height of surface above water at high and low tide.
 - Effects of surf.
 - Effects on tide.
 - Channel through reef (alignment, width, and depth at low water).
- Offshore Conditions
 - Water depth.
 - Offshore islands (location and characteristics).
 - Sandbars.
 - Location and distance from low water shoreline.
 - Length and width.
 - Consistency.
 - Slope (seaward and landward).
 - Passages (alignment, width, and depth).
 - Depth at high and low waters.
 - Obstacles (type, location, and characteristics).
- Beach features. Natural and manmade features such as cusps, runners, stream mouths, groins, piers, and outfall pipes, etc.
 - Type and location.
 - Number and extent.
 - Bypass possibilities.
 - Influence on operations.
- Tide
 - Type (diurnal, semi-diurnal, or mixed).
 - Type range (spring, topic, and diurnal).
 - Range.
 - Meteorological effects.
- Surf
 - Breakers (type, average height, distance formed from shore, f lines).
 - Period.
 - Width of surf zone.

- Direction from which swells approach coast.
- Weather and seasonal effects.
- Currents. Location, direction, and velocity.
- Beach exits.
 - Type and location.
 - Number and condition.
- Coastal terrain. Cross-reference to appropriate collection file.
 - Critical terrain features (location, type, bypasses, and influence on operations).
 - Obstacles (location, type, extent, bypasses, and influence on operations).
 - Cross-country movement (troops, wheeled vehicles, and tracked vehicles).
- Support area concealment and cover (location and type).

- Dispersal and storage area. Location and description.
- Availability of fresh water. Location and quantity.
- Defenses. Location and type.

Terrain overlays are normally prepared by the terrain analysis detachment and added to the checklist. Overlays include presentations depicting cross-country movement, vegetation, slope, soil drainage pattern, ridgelines, etc.

Beach Landing Site Overlays

IAs assist all-source intelligence and GEOINT analysts with preparing overlays of the proposed primary and alternate beach landing sites. Beach landing sites are referred to by their nickname. See MCWP 2-12.1 for information on preparation of overlays.

APPENDIX H. IMAGERY AND SUPPORTING INTELLIGENCE REPORTS

This appendix provides examples of MAGTF intelligence products derived from the fusion of available imagery and supporting IMINT and all-source intelligence reports. Such products support tactical planning and decisionmaking. The examples provided are:

- Image and supporting intelligence report for the MOUT facility, Camp LeJeune, NC.
- Image and supporting intelligence report for the Marine Corps Air Station, New River, NC.
- Image and supporting intelligence report for Helicopter Landing Zone Vulture, Camp LeJeune, NC.
- Image and supporting intelligence report for Onslow Beach North, Camp LeJeune, NC.
- Image and supporting intelligence report for Kin Red Beach, Okinawa, Japan.

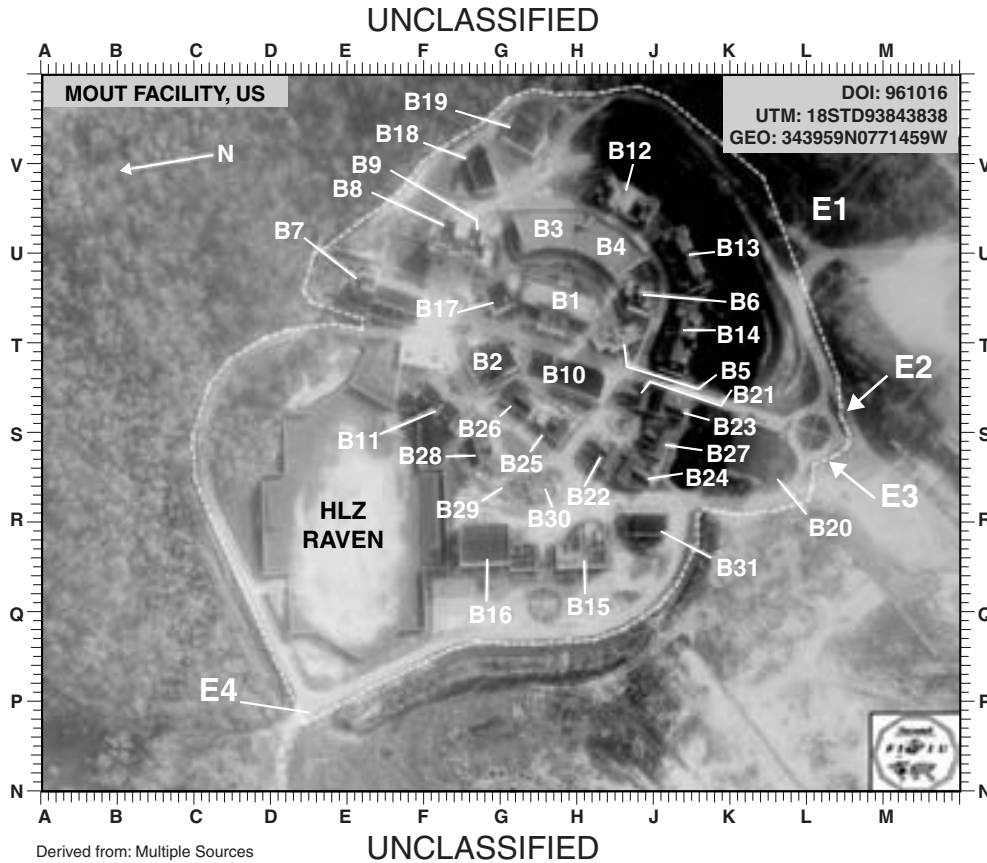

MOUT FACILITY

Center Coordinates

UTM 18STD93843838
GEO 343959N0771459W

Map Reference

Sheet: Camp Lejeune MIM
Series: V742S
Edition: 1-DMA
Datum: NAD 83/WGS 84

Size

Length 1025 ft (312 m)
Width 800 ft (244 m)

Surface Material

Silty sand
Gravel

Remarks: The MOUT facility is located approximately 2 km ENE of OP-2. The primary use of the MOUT facility is combat training in an urban environment. The MOUT facility consists of 31 buildings of varying sizes and shapes. Roof types are a mixture of garbled and flat. The facility is surrounded by trees of varying heights. The exit from the MOUT facility is a loose surface road which provides access to Lyman road. Note: All building measurements are listed at length x width x height.

Exits

Anno. #	Type	True Bearing	Distance	Width	Surface Material
E1	Road, loose-surfaced	146	169.8 m (557 ft)	7.6 m (25 ft)	Earth and sand
E1	Road, loose-surfaced	175	163.1 m (535 ft)	6.4 m (21 ft)	Earth and sand
E1	Road, loose-surfaced	181	165.0 m (541 ft)	6.7 m (22 ft)	Earth and sand
E1	Road, loose-surfaced	281	204.3 m (670 ft)	5.6 m (18 ft)	Earth and sand

Remarks: E1 leads approximately 100 meters (328 feet) southeast to F-3 Range Road. E2 and E3 lead approximately 1.0 km (0.5 nm) to Lyman. E4 exits onto an unnamed road.

Buildings

B1—Three-story, T-shaped building (hotel), 120' x 58' x 37' (37 x 18 x 11 m) with near-flat roof. Helicopter landing point is painted with non-reflective white airfield markings and consists of a concrete slab roof. HLZ is 38' x 33' (12 x 10 m). OP building roof is outlined by a parapet with scuppers and a gutter. (Scupper is an opening in the wall of a building through which water can drain). The front portion of the roof is comprised of tube trusses or transverse monitors. Grappling and rappelling anchors are located throughout the roof.

B2—Two-story, square-shaped building (city hall), 72' x 60' x 31' (22 x 18 x 9 m) consisting of a near flat roof outlined by a parapet, however the NW corner is lower than the main roof. The roof has grappling and rappelling anchors throughout the roof. The corner of the roof is open to a crawl space.

B3, B4—Two-story, crescent-shaped buildings (apartment buildings) outer edge 121' x 60' x 31' (37 x 18 x 9 m) inner edge 84' x 60' x 31' (26 x 18 x 9 m) outlined by a parapet with scuppers. Grappling and rappelling anchors are located throughout the roof. The roofs are near flat with a ridge dissecting each building's roof, a near flat roof dissected by a ridge separates the two buildings.

B5—Three-story, basically rectangular-shaped building (office building) 72' x 36' x 38' (22 x 11 x 12 m). Grappling and rappelling anchors located on the SE and NW sides of roof. The southern end of the building is two stories, 23 ft (7 m) in height. An elevator shaft is located in the center of the roof.

B6—Two-story, "I"-shaped building (office building) 44' x 36' x 25' (13 x 11 x 8m). NW portion of the roof is a concrete slab.

B7—Rectangular "T"-shaped building with dormers (church building) 121' x 73' x 77' (37 x 22 x 23 m) with a gable roof made of asphalt and fiberglass shingles. Height of main building is 48 ft (15 m), steeple 29 ft (9 m).

B8—Three-story, irregular-shaped building (business/residential building) 53' x 34' x 39' (16 x 10 x 12 m) with near flat roof. Grappling and rappelling anchors are located throughout the roof.

B9—Three-story, irregular-shaped building (business/residential building) 50' x 47' x 39' (15 x 14 x 12 m) with near flat roof.

B10—Single-story, rectangular-shaped building (business/residential building) 128' x 46' x 18' (39 x 14 x 5 m) with flat roof.

B11—Two-story, rectangular-shaped building (townhouse) 103' x 53' x 30' (31 x 16 x 9 m) has gable roof with dormer. Roof consists of fiberglass shingles reinforced by wood trusses.

B12—Two-story, rectangular-shaped building (townhouse) 103' x 53' x 30' (31 x 16 x 9 m), front and rear portions of building walls are incomplete. Gable-roofed dormer with fiberglass shingles and reinforced wooden trusses.

B13, B14—Two-story, rectangular-shaped buildings (townhouses) 103' x 53' x 30' (31 x 16 x 9 m) with gable roof and dormers. Roof consists of fiberglass shingles reinforced with wooden trusses.

B15—Two-story, irregular-shaped building (school) 88' x 73' x 25' (27 x 22 x 18 m) with near flat roof built up on A 2" slab of concrete. Rappelling anchors are located throughout the roof. Two fire escape ladders are located on the NE and SW sides of the roof.

B16—Two-story, irregular-shaped building (gymnasium) 128' x 74' x 25' (38 x 23 x 8 m) with a near flat roof, fire escape ladders located on the S side of the building.

B17—Two-story, square-shaped building (retail bank) 43' x 36' x 26' (13 x 11 x 8 m) with a near-flat roof. Grappling anchors located throughout the roof. Roof access by ladder is located on the NW corner of the building.

B18—Single-story, basically rectangular-shaped buildings with hipped roofs (service stations) 74' x 32' x 17' (23 x 10 x 5 m).

B19—Single-story, rectangular-shaped building (warehouse) 63' x 43' x 23' (19 x 13 x 7 m) with a near flat roof. Roof consists of standing seam metal on metal purlins. Purlins are horizontal timbers supporting the rafters of a roof.

B20—Single-story, square-shaped building (warehouse) 83' x 63' x 25' (25 x 19 x 8 m) with a near flat roof on metal purlins, with a mellaine (mellaine is a partial story between two main stories of a building). The MOUT CTF administration building is not a part of the MOUT training facility.

B21, B22—Single-story, "T"-shaped buildings with basements (residential buildings) 52' x 40' x 15' (16 x 12 x 5 m). Gable style roof is reinforced with wooden trusses. Chimney height extends 2 ft (.6 m) above the peak of the roof.

B23, B24, B26—Single-story, "T"-shaped buildings (residential buildings) 52' x 40' x 15' (16 x 12 x 5 m) with gable style roof reinforced with wood trusses. Chimney extends 2 ft (.6 m) above peak.

B25—Residential irregular-shaped building 52' x 40' x 15' (16 x 12 x 5 m) with a gable style roof reinforced with wood trusses.

B27, B28—Single-story, "T"-shaped buildings (residential buildings) 44' x 40' x 17' (13 x 12 x 5 m) with reinforced wooden trusses. Gable roofing consists of fiberglass shingles.

B29, B30—Small "T"-shaped buildings 44' x 40' x varies (13 x 12 x varies m). Nearly destroyed buildings may provide some shelter from direct fire.

B31—Single-story, rectangular-shaped buildings with hipped roofs (service stations) 74' x 32' x 17' (23 x 10 x 5 m).

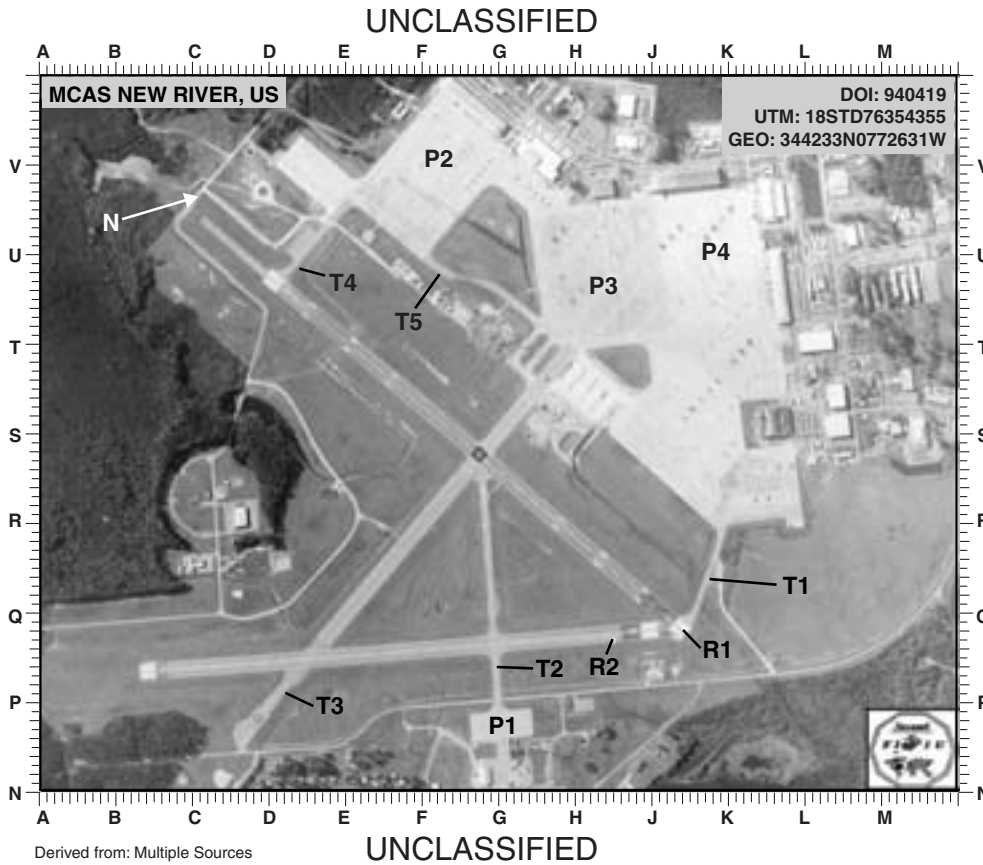

MCAS NEW RIVER

Center Coordinates

UTM 18STD76354355

GEO 344233N0772631W

Elevation 25 ft (8 m)

Night landing capable: Yes

Map Reference

Sheet: Camp Lejeune MIM

Series: V742S

Edition: 1-DMA

Datum: NAD 83/WGS 84

Runways

No.	Mag Bearing	Length	Width	Surface Material	Capability
R1	50/230	5098 ft (1554 m)	150 ft (46 m)	Asphalt	C-141
R2	10/190	5075 ft (1547 m)	150 ft (46 m)	Asphalt	C-130

Taxiways

No.	Length	Width	Surface Material	Type	Remarks
T1	775 ft (236 m)	25 ft (8 m)	Asphalt	Link	Connects to P4 to R1 and R2
T2	1850 ft (564 m)	38 ft (11 m)	Asphalt	Link	Connects R1 and R2 to T3
T3	3500 ft (1066 m)	107 ft (33 m)	Asphalt	Link	Connects R1 and R2 to P3
T4	718 ft (219 m)	55 ft (17 m)	Asphalt	Link	Connects R1 to P2
T5	2500 ft (762 m)	53 ft (16 m)	Asphalt	Link	Connects P2 to P3 and P4

Parking Areas

No.	Length	Width	Surface Material
P1	582 ft (177 m)	263 ft (80 m)	Concrete
P2	1328 ft (405 m)	894 ft (272 m)	Concrete
P3	1388 ft (423 m)	973 ft (297 m)	Concrete
P4	3144 ft (958 m)	1222 ft (372 m)	Concrete

Remarks: MCAS new river is bordered to the east by New River and to the southwest by Southwest Creek. Trees and buildings of various heights surround the airfield.



HLZ VULTURE

Center Coordinates

UTM 18STD76123004
GEO 343516N0772627W

HLZ Size

Length 1209 ft (369 m)
Width 215 ft (66 m)

Map Reference

Sheet: Camp Lejeune MIM
Series: V742S
Edition: 1-DMA
Datum: NAD 83/WGS 84

HLZ Shape

Irregular

HLZ Type

Open Field:

Surface Material

Scrub Grass

Exits

No.	Type	Distance and Grid Azimuth from HLZ Center	Width
E1	Loose surface road	182 ft (55 m) 280 Deg	20 ft (6 m)

Flight Hazard

No.	Type	Height and Grid Azimuth to HLZ Center
See	remarks	

Remarks: The HLZ is located 600 m S of stone bay rifle range. E1 exits the HLZ on the W side extending N on Booker Washington Boulevard to the rifle range or W to range road. The western perimeter of the HLZ has four (4) buildings that may present flight hazards. The HLZ is surrounded on the N, S, and E sides by trees of varying height which may constitute flight hazards to low-flying aircraft. Blowing sand and debris caused by rotor wash may produce flight hazards. Adjacent terrain consists of a dissected plain, vegetated with trees and brush.

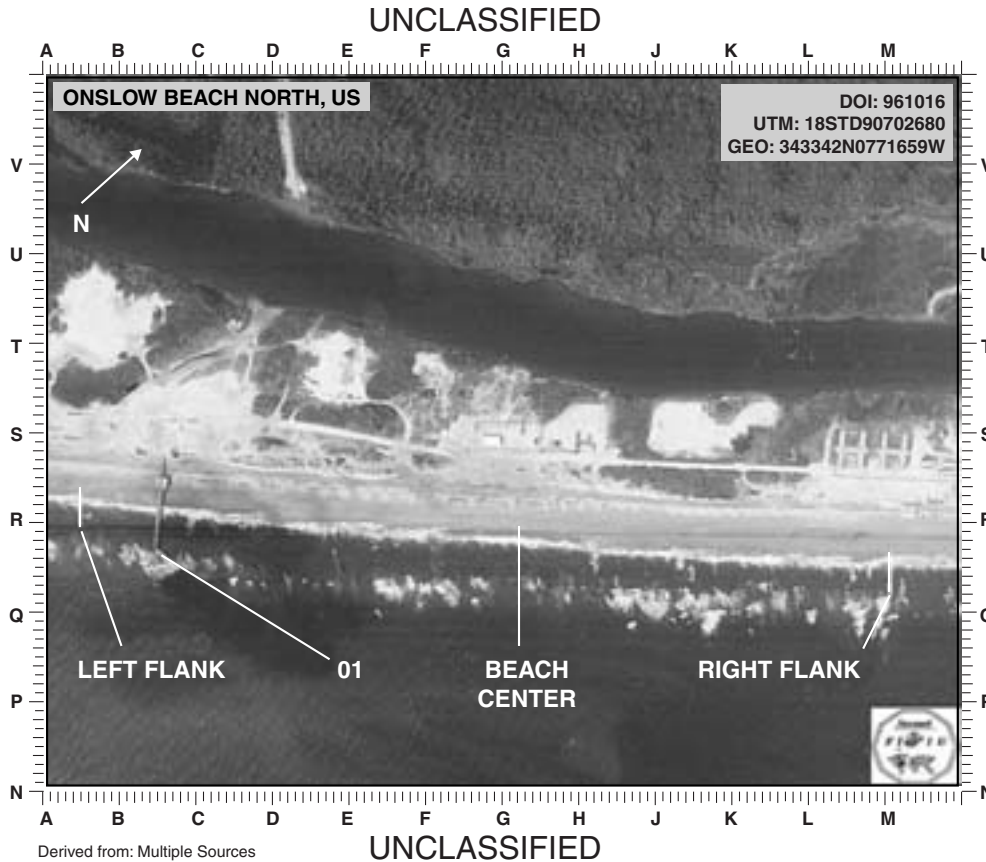

Onslow Beach North

Map Reference

Sheet: Camp Lejeune MIM
 Series: V742S
 Edition: 1-DMA
 Datum: NAD 83/WGS 84

Left Flank

UTM 18S2901338263F
 GEO 343327N0771714W

Beach Center

UTM 18S29071382670
 GEO 343341N0771636W

Right Flank

UTM 18S2930382730
 GEO 34335N0771633W

Length

Total: 1,393.4 m (4,752 ft)
 Usable: 1,373.1 m (4,505 ft)

Width

Average Backshore Width: 66.4 m (218 ft)
 Visible Foreshore Width: 24.0 m (79 ft)

Surface Material

Nearshore: Sand and mud
 Foreshore: Sand
 Backshore: Sand

Trafficability

Personnel: Wet—Fair
 Dry—Good
 Wheeled: Wet—Fair
 Dry—Good
 Tracked: Wet—Fair
 Dry—Good

Tides

Tidal type: Diurnal
 Tidal range: 1.0 m (3 ft.)

Average beach gradient: 1:116
 Firmness: Firm when wet

Matting recommended: Yes

MFP capable: No; see remarks.
JLOTS capable: No; see remarks.
LCAC offload capable: Yes; see remarks.

Location: Onslow Beach North is approximately 13.1 km (7.1 nm) south-southeast of the U.S. Embassy. It is 3.7 km (2.0 nm) east-northeast of HLZ BLUEBIRD and 1.4 km (0.8 nm) east-southeast of HLZ Albatross.

Characteristics remarks: Onslow Beach North is not MPF capable since there is no MPF capable port within 92.7 km (50 nm) of the beach. It is not JLOTS capable due to insufficient beach gradient. It is, however, LCAC off-load capable due to average backshore width of 66.4 m (218 ft). All coordinates provided in this report were derived from the 1:50,000 scale map sheet listed in the reference above. All measurements were derived by MEF imagery analysts from mensurated imagery.

Obstructions

Anno. #	Type	True Bearing	Distance	Length	Width
N1	Pier	225	542.0 m (1,778 ft)	20.3 m (67 ft)	4.5 m (15 ft)

Obstruction remarks: None

Exit remarks: Cross-country to partial cross-country exits are available along the entire beach. These exits are too numerous to list individually. Parallel to the beach is a road that extends 6.3 km (3.4 nm) southwest to New River Inlet and 1.4 km (0.8 nm) northeast to Onslow Beach Road which leads approximately 2.8 km (1.5 nm) north-northeast to Highway 172. There are several buildings and compounds in the hinterland along the road.

KIN RED BEACH

GEOCORD: 262636N1275454E

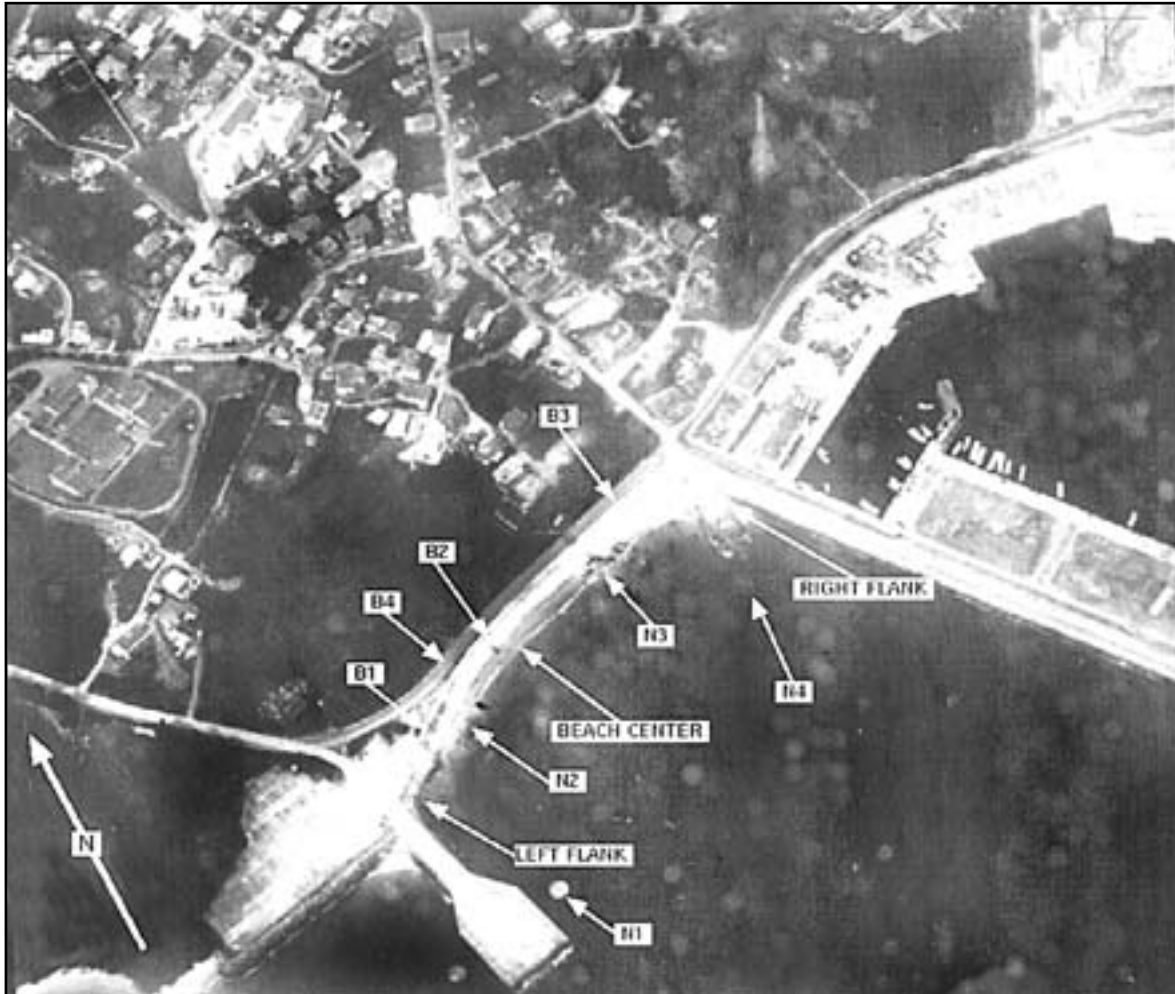

DERIVED FROM: MULTIPLE SOURCES
 DECLASSIFY ON: XI
 PRODUCED BY: IIP, P&A Co, 3D INTEL BN

PHOTO DATE: 09 AUG 96

KIN RED

Left Flank

UTM: 52RCE91642500
 GEO: 262636N1275449E

Beach Center

UTM: 52RCE91782515
 GEO: 262636N1275454E

Right Flank

UTM: 52RCE91922496
 GEO: 262635N1275459E

Shape: Straight

Length

Total: 274 m (899 ft)
 Usable: 151 m (496 ft)

Width

Average backshore width: 16.4 m (218 ft)
 Visible foreshore width: 24.0 m (79 ft)

Surface Material

Nearshore: Sand/Coral
 Foreshore: Sand/Coral
 Backshore: Sand

Trafficability

Personnel:	Wet—Good Dry—Fair
Wheeled:	Wet—Good Dry—Fair
Tracked:	Wet—Fair Dry—Poor

Tides

Tidal type: Mixed

Average beach gradient: 1:116

Matting recommended: Yes

Tidal range: 1.7 m (5.6 ft)

Firmness: Firm when wet

Location and general remarks: Kin Red Beach is located 17.6 km northeast of Kadena Airfield. Four islands obstruct the mouth of Kin Bay. The beach is flanked by a RO/RO pier to the west and a breakwater to the east. There are intermittent streams that cross the beach that could hinder lateral movement during inundation. Personnel exit via cross-country along the entire beach length. The beach is backed by a concrete stepped seawall (B4) that severely restricts tracked vehicle and prevents wheeled vehicle movement. The town of Kin Cho further hinders and channels movement from the beach. Hinterland consists of hills covered with dense vegetation of varying heights, cultivated fields, numerous urban developments and/or tombs.

Obstructions

Anno. #	Type	True Bearing	Distance	Length	Width
N1	Dolphin	226	157 m (515 ft)	3 m (10 ft)	3 m (10 ft)
N2	Coral	250	86 m (282 ft)	18 m (59 ft)	20 m (66 ft)
N3	Coral	090	46 m (150 ft)	32 m (105 ft)	12 m (38 ft)
N4	Coral	113	92 m (302 ft)	40 m (131 ft)	32 m (105 ft)
B1	Coral	261	94 m (308 ft)	8 m (26 ft)	7 m (23 ft)
B2	Coral	270	26 m (85 ft)	14 m (46 ft)	9 m (30 ft)
B3	Coral	077	51 m (167 ft)	16 m (52 ft)	13 m (43 ft)
B4	Coral	270 thru 070	Varies	270 m (886 ft)	9 m (30 ft)

Obstruction remarks: Obstructions are measured from the beach center to the obstruction.

Exit remarks: See location and general remarks above.

APPENDIX I. IMAGERY INTELLIGENCE TARGET FOLDERS

A target folder contains intelligence that provides location, the components of a target or target complex, indicates its vulnerability(ies), and its relative importance. It also contains related materials prepared for planning and executing actions against a specific target. A major prerequisite for starting a target folder is the relative degree of permanence of the potential target. In addition, local command SOPs will provide guidance as to targets needed to have folders maintained.

Imagery Analysis

IMINT is often the definitive information source of intelligence support to targeting. IMINT input is reliable, accurate, and current, and often forms the basis for targeting decisions. Imagery analysis is a vital component in the tactical and strategic targeting process. It is often the IA, during the analysis of imagery, who—

- Discovers potential targets and draws them to the attention of the command (CMD section).
- Conducts the target study that is an analysis of the proposed target from imagery and other pertinent sources.
- Takes the information provided by the target analysis and puts it into a target folder format.

Target Analysis

The intelligence support coordinator (ISC) is responsible to the AC/S G-2 for imagery intelligence efforts supporting the MEF's targeting process. Before a possible target can be selected for attack, it must be developed to the point where its composition, strengths, and vulnerabilities are well known.

- The analysis of a target requires the collection and evaluation of many items of information.

The target folder is an instrument for the compilation and organization of relevant data produced by the target analysis. Decisions by the force fires coordinator and FSCs regarding whether to attack a proposed target and weapon system selection are critically influenced by the information in the target folder.

- Once a possible target has been identified and approved for inclusion in the target intelligence data base, the IA and all-source intelligence analysts will prepare a target folder. This analysis presents all available pertinent information on the proposed target from the following sources:
 - **Reference Materials.** Perform a thorough check of all available intelligence reference materials. Interrogation, CI, ground reconnaissance, and signals intelligence reports all may be useful.
 - **GEOINT.** Ensure current maps (latest editions) and other GEOINT are available of the target area.
 - **Mission Coverage.** Examine comparative coverage of the target area from past and ongoing imagery collections missions. If the latest available coverage is old, incomplete, poor quality or the installation is under construction or renovation, new collection missions may be required.

Specifications

A target folder is a unit-created and maintained reference file on permanent potential targets in the AO and AOI. It contains the results of the target study (analysis) and any updates or collateral intelligence. Target folders—

- May be used as a pre-mission briefing aid for aircrews to orient them on target location, recognition, defenses, and obstacles. IAs may use target folders strictly as a reference file on important

intelligence targets within the unit's AO. Such folders can be compiled to show an installation's development or an enemy unit's organization.

- Have common characteristics and contain a minimum of important elements.
- Are for permanent targets. A permanent C2 node, troop training area, warehouse area, port facility or fixed missile site are good potential targets for target folders. Temporary targets such as troops in the field, supply dumps, and ships in port or truck convoys are usually not proper subjects for target folders.
- Are current. Because the information within a target folder may be used for target planning, it must be kept current. The target folder must be updated to reflect changes in defenses, physical characteristics, unit reorganization, important equipment, and so on.
- Are concise. Target folders are compact; only intelligence and other information pertinent to the commander's PIRs or IRs are included.
- Are accurate. Intelligence and other information within a target folder must be accurate to allow realistic targeting plans to be made. Answers to intelligence requirements must be specific to provide maximum value. For example, explicitly describe enemy defenses, target dimensions, shape, construction, use, and capacities.

Note: Target folders should be reviewed periodically or with each new photograph mission (intelligence priorities, resources, and time permitting) and their contents checked against new information or intelligence requirements.

Format and Components

There is no standard format for a target folder. Instead, it is a product tailored to meet all supported commanders' intelligence requirements.

Although the contents of a target folder will vary according to unit SOP, most will at a minimum contain the following components:

- Target folder index.
- Target worksheet.
- Target information sheet.
- Target illustration sheet.

The following items can be used to supplement the target folder:

- Target history sheet (supplement to the target worksheet).
- Map extract (supplement to the target information sheet).
- Sketch map or photographic overlay (supplement to the target information sheet).
- Building dimensions (supplement to the target illustration sheet). See appendix H for appropriate formulas for computing dimensions on imagery.

Target Folder Index

The index is located on the outside cover or on the first page of the target folder. It displays the contents of the folder (see figure I-1).

TARGET FOLDER INDEX	
(Target Name)	
	Page
Target worksheet	1
Target history sheet	2
Target Information sheet	3
Map extract	4
Sketch map	5
Target illustration sheet	6
Building or facility dimensions	7

Figure I-1. Sample Target Folder Index.

Target Worksheet

The target worksheet (see figure I-2) is organized with seven subheadings:

TARGET WORKSHEET	
TARGET NUMBER:	2345-A23456
TARGET DESCRIPTION:	Sulphur Springs Valley Electric Power Station
TARGET LEADS:	Location: 320423N1105035W Elevation: 4,200 Feet Accuracy: Horizontal = +/- 100 Meters Vertical = +/- 10 Meters Datum: WGS 84 Source: V798, Douglas, AZ, Ed 5, 4048-1, Jun 86, DMAAC
SOURCES OF INFORMATION:	MSN 06-2028, 16TRS, 22 Jun 89, Photos V001-V010; EPW, 31 May 89 (F-6)
DATE OF INFORMATION:	10 Jun 99
DATE CONFIRMED AND SOURCE:	22 Jun 99, Imagery
DISTRIBUTION:	G-3, Force Fires Center, 1st MARDIV, 3d MAW

Figure I-2. Sample Target Worksheet.

Target Number

This number indicates the number of targets evaluated. For example, if the target number is 086, then it is the 86th target that the section has processed.

Target Description

Enter the name of the target and/or type of target. The type of target could be an airport, oil refinery, electric company, munitions plant, chemical plant, bunker complex or base area. If you have more than one of the same types of targets in the same area, you will number them (e.g., Bamberg SAM Site No. 3).

Target Leads

LEADS stands for: location (geographic coordinates), elevation, accuracy (horizontal and vertical), datum, and source (imagery, maps, etc.).

- Enter the geographic coordinates of the target, expressed in degrees, minutes, seconds; North or South (N or S) and East or West (E or W), depending on the location in regard to the equator and the prime meridian. Coordinates will represent the center of mass of the target.
- Include the elevation.
- Include horizontal and vertical accuracy.
- Include the datum (basis for the accuracy of the coordinates) used to derive the target location.
- Include the source of the information.

Sources of Information

Enter all other sources of information and intelligence available on the target. If possible, a P&A cell evaluation of the information and intelligence would be included (e.g., A-2, F-6). The map reference must include: series, sheet name, edition, sheet number, date, and production agency.

Date of Information

The date of the information is recorded on the target worksheet.

Date Confirmed and Source

Enter the date the target was confirmed and how it was confirmed. When using imagery, the date of information becomes the date of confirmation.

Distribution

Include those units and other agencies that normally receive the intelligence. Additionally, include all those that have requested the intelligence.

Target Information Sheet

A target information sheet (see figure I-3 on page I-4) is a detailed target description and continuation of the target worksheet information.

TARGET INFORMATION SHEET			
BE NO:	0501-D57010	TARGET NO:	023
DATE OF INFO:	24 Nov 89	MAP SERIES:	V798
DATE COMPILED:	(Completion or update)	MAP SHEET NO:	4048 I
PROD CMD & NO:	5IDM-02	GEO REF GRID:	320423N1105035W
ELEVATION (MSL):	4,200 ft	UTM REF GRID:	12SXL00450474
LOCATION: The Sulphur Springs Valley Electric Power Station is located 36 mi SW of WILCOX, AZ, and 15 mi SE of the Southern Pacific Railroad tracks.			
PHYSICAL CHARACTERISTICS: The target is 1,773 ft x 1,420 ft, located west of the highway. The RP is the generator hall that is a 56 ft x 174 ft, probably reinforced, with the following components: Boiler house is 59 ft from the RP on a 320-degree MAG heading. Substation (Transformer Yard) is 260 ft from RP on a 145-degree MAG heading. Fixed-top non-pressure liquid storage tank is 462 ft from RP on a 304-degree MAG heading. Coal Crushing Tower is 462 ft from RP on a 255-degree MAG heading. American Deck Coolers are 304 ft from RP on a 019-degree MAG heading. Smokestack is 174 ft from RP on a 320-degree MAG heading.			
SIGNIFICANCE: The destruction of this target would stop or reduce electrical power to enemy military units in the vicinity.			
OBSTRUCTIONS: The following obstruction is located within the target complex: 173 ft high smokestack 174 ft from RP on a 320-degree MAG heading. There are no visible obstructions outside the complex.			
WEAPON RECOMMENDATIONS:			
1. MEAN POINT OF IMPACT:			
2. PRIMARY WEAPON:		FUZING:	
3. ALTERNATE WEAPON:		FUZING:	
4. ON TARGET TONNAGE:		LEVEL:	
5. OVER TARGET TONNAGE:		LEVEL:	
OTHER INFORMATION: There are no visible bunkers, SAM sites or other antiaircraft emplacements.			

Figure I-3. Sample Target Information Sheet.

Heading

The heading includes the classification and sheet name (TARGET INFORMATION SHEET).

Main Portion

The main portion of the target information sheet contains the following:

- **BASIC ENCYCLOPEDIA (BE) NO:** This is a number assigned to a specific target by the DIA. If a permanent BE number does not exist, an interim BE number may be used in accordance with unit or JTF SOP. The interim BE number must consist of 10 characters. The first four characters are composed of the World Aeronautic Chart Number on which the target is located; the remaining 6 characters are a combination of digits and letters determined by

the unit SOP. Once this interim BE number is used, it must be used in all subsequent reporting on the target until DIA assigns a permanent BE number.

- **DATE OF INFO:** Enter the date of the most recent aerial imagery available in the target folder.
- **DATE COMPILED:** Enter the date when the target information sheet is completed or updated.
- **PRODUCING COMMAND & NUMBER:** Enter the producing command abbreviation and number.
- **ELEVATION (MSL):** Enter the target's actual elevation above mean sea level (MSL). This is obtained from the map sheet and is the elevation read from the contour lines, using the contour interval. The elevation may have to be interpolated when the target falls between two contour lines.

- **TARGET NO:** Transcribe the target number from the target worksheet.
- **MAP SERIES:** This is obtained from the map the target is located on. Transcribe map series from target worksheet (see figure I-2).
- **MAP SHEET NO:** This is obtained from the map. Transcribe map sheet number from the target worksheet (see figure I-2).
- **GEO REF GRID:** This is obtained from the map. Transcribe GEO coordinates from the target worksheet (see figure I-2).
- **UTM REF GRID:** This is obtained from the map. Transcribe UTM coordinates from the target worksheet (see figure I-2).
- **LOCATION:** Enter the physical location. For example, the Sulphur Springs Valley Electric Power Station is 3.6 miles (mi) SW of Wilcox, AZ, and 15 mi SE of the Southern Pacific Railroad tracks.
- **PHYSICAL CHARACTERISTICS:**
 - This is a complete description of the target. Identify the critical item within the target complex. The critical item is defined as: A component of the entire complex without which the complex would stop operation for the longest period of time. This critical item then becomes the primary target (PT). Determine the construction of the PT. Calculate the dimensions of the reference point (RP) to the target complex. Provide answers to the following questions: Is it operational? How far and in what direction or magnetic (MAG) heading are the other components of the complex from this RP?
 - The RP must be readily identifiable by the aircrews. If the critical item or PT is not readily identifiable from the air, determine through a process of elimination that RP the aircrews could distinguish from the air (e.g., smokestack, isolated storage tank, water tower). From this RP indicate in what direction and distance the PT is located. Are there railroads and highways close to the complex and in which direction? How many lanes are in the highway and what is it numbered (Hwy 40)? Are there service roads entering the complex? From which direction? How many lanes? Is the complex serviced by a rail spur? If so, from which direction does it enter the complex?
- If extremely detailed target intelligence analysis is required, a sketch map or appendix may be used for enhancement.
- To calculate dimensions to the target complex, use the formula $GD = PD \times DPRF$.
Example: If PD is .008 ft and DPRF is 10,000, then $GD = .008 \text{ ft} \times 10,000 = 80 \text{ ft}$.
- MAG is determined by placing the cross of the coordinate scale over the RP and shooting an azimuth toward the target. Read the grid-azimuth and add or subtract the grid-magnetic (GM) angle as specified in the map sheet legend. The GM angle is positive when it is being added to the grid azimuth, negative when subtracted from the grid azimuth. The RP is the roasting and sintering building. The grid azimuth to the receiving and handling building in the copper smelter complex is 299 degrees. By subtracting the GM angle, the MAG heading is 296 degrees.
- **SIGNIFICANCE:** This is a statement as to the significance of the target.
Example: "Destruction of this target will deny the enemy 100,000 barrels of POL."
- **OBSTRUCTIONS:** List all obstructions in or near the target area that would hamper low-flying aircraft. External obstructions include urban areas, radio and television towers, power line towers, bridges and/or mountain ranges in proximity to the target RP. Obstructions within the target complex include smokestacks, water towers, high-tension power lines or towers, conveyor systems, etc.

- **WEAPON RECOMMENDATIONS:** Enter the format sub-headers that FFC or FSCC personnel will complete in this section.
- **OTHER INFORMATION:** Enter data not covered by the other subheadings that could have a bearing on the target, such as defenses.

Examples: There are no visible bunkers, SAM sites, or antiaircraft emplacements. The target is encircled by SAM sites with 10 bunkers 2,000 ft from the center of the complex.

Target Illustration Sheet

A target folder is incomplete without illustrations. This includes as a minimum of one up-to-date annotated vertical photograph of the target. All imagery must have an accurately positioned magnetic north arrow, and the vertical photograph should have the boundaries of the target area outlined conspicuously. Oblique imagery can be included in the folder because it will aid in identifying the target from the air. Radar and infrared signatures are also helpful.

Target History Sheet

The target history sheet is a supplement to the target worksheet. It will follow the target worksheet in numerical sequence (see figure I-4).

Top

The top of the target history sheet contains a heading composed of the target’s BE number (or unit assigned identification number), target name, target data inventory (TDI) category (optional), country, GEO/UTM coordinates, and map reference.

Body

The body of the target history sheet contains a listing of all reconnaissance missions with reference to the target. The columns are for mission date, mission number, quality of the imagery, action taken because of information extracted from the imagery (for example, “none,” “new sketch map,” “new target description,” “significant change,” etc), and the name of the IA who completed the imagery analysis.

Map Extract

A map extract of the target area may be used to supplement the target information sheet.

Sketch Map or Photograph Overlay

Some unit SOPs may require that a sketch map or photographic overlay of the target be included in

TARGET HISTORY SHEET					
BE NO:	_____	TARGET NAME	_____		
TDI CATEGORY	_____	COUNTRY	_____		
GEO/UTM COORDS	_____ / _____				
MAP REFERENCE	_____				
COMPONENT	_____				
	DATE	MISSION NO.	QUALITY	ACTION	IA
1					
2					
3					
4					

Figure I-4. Sample Target History Sheet.

the folder as supplementary information. The sketch map is a graphic representation of the target showing sufficient detail to satisfy IRs. Usually the sketch map will illustrate critical buildings and structures, transportation facilities (including roads), obstacles, defenses, and security measures.

A photographic overlay or sketch must convey a picture of what is on the ground (target and components) with the numbers or letters used to identify the important components and areas. RP is to represent the primary target or a more prominent feature. A properly prepared overlay should resemble the one in figure I-5 on page I-8. The location of numbers and lines need to be identical to the illustration. Avoid having lines cross features and other lines on the overlay.

General Information

Sketch maps are drawn freehand and are not to scale. If the photograph or map is drawn to scale, the scale is indicated. A magnetic north arrow, title, annotation, legend, date, and sketcher's unit, rank, name, are needed for a complete map. The classification must be indicated at top and bottom of the sketch map in larger than normal lettering.

Annotations

The following are methods of annotating on an overlay or photograph:

- The banding method is used when the photographs are of a large enough scale to place the annotations on top of each item so the item can still be seen. In this method, you would start to number the item at the upper left and continue across the illustration in a band; then return to the left edge and repeat. If there is a primary installation, number it "1," whatever its location

in the illustration. Number 2 will then be the first designation in the upper left.

- The most preferred method is annotating by priority (listing in sequence of target components' significance), which is accomplished for those targets selected for tactical planning and bombing.
- Another method is alphanumeric code. In this method targets are grouped together by function and given an alphabetic designator (i.e., headquarters = A). The individual elements within the group are given a numeric designator (i.e., division headquarters A1, brigade headquarters A2, A3, etc.) The designators are given in order of priority. So A is the most important group and 1 is the most important element within the group.
- The last method is as specified in unit SOP.

The following suggestions may prove helpful in preparing your overlay:

- Do NOT place numbers or letters on top of small items being identified.
- Do NOT draw the lines so they intersect other lines or pass over important items.
- Place magnetic north arrow away from other annotation lines and orient it toward the top of the illustration.

Building Dimensions

Building and facility dimensions may be added to the target illustration sheet as supplementary information (see figure I-6 on page I-9). It should show the title (e.g., building dimensions), installation name (e.g., Sulpher Springs Valley Electric Power Station), RP annotation, type building or facility (e.g., generator hall), and dimensions (e.g., in feet or meters).

UNCLASSIFIED

TARGET SKETCH

TARGET NAME: Sulphur Springs Valley Electric Power Station
BE NO: 0501-D57010
DATE OF INFO: 21 Jun 81
GEO REF GRID: 320423N1105035W
UTM REF GRID: 12SXL00450474
SCALE: 1:5,000

ANNOTATIONS:

RP: Generator hall - PRIMARY TARGET	6. Smokestack
1. Boiler house	7. Water tower
2. Substation	8. Coal storage area
3. Storage tanks	9. Highway 666
4. Coal crushing towers	10. Service road
5. American deck coolers	11. Railroad tracks

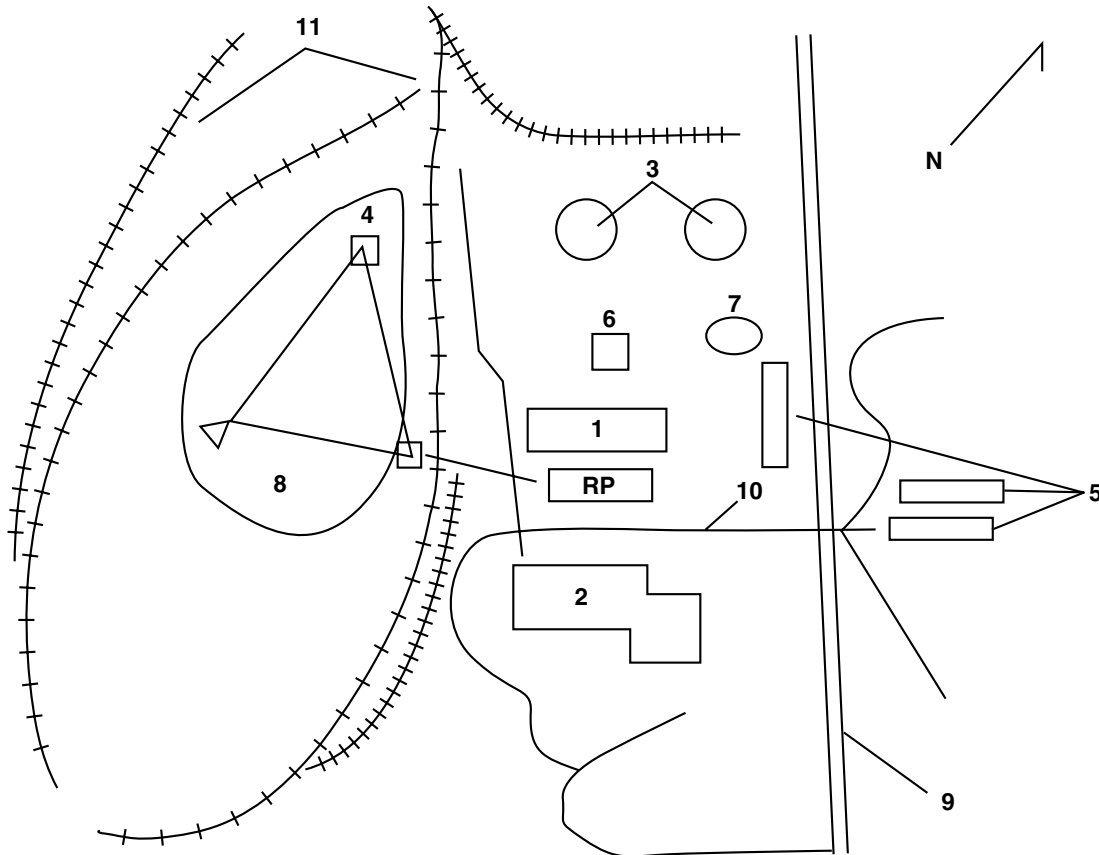

UNCLASSIFIED

Figure I-5. Sketch Map.

TARGET ILLUSTRATION SHEET		
BUILDING DIMENSIONS		
Sulpher Springs Valley Electric Power Station		
Annotation	Type Building/Facility	Dimensions
RP	Generator hall	56.0 ft x 174.0 ft
1	Boiler house	85.6 ft x 120.0 ft
2	Transformer yard	50.0 ft x 200.0 ft
3	Fixed top non-pressure liquid storage tank	20.0 ft x 10.0 ft
4	Coal crushing tower	20.0 ft tall
5	American deck coolers	20.0 ft x 120.0 ft
6	Smokestack	223.0 ft tall

Figure I-6. Sample of Building Dimensions.

APPENDIX J. NATIONAL IMAGERY TRANSMISSION FORMAT COMPRESSION

We use compression to decrease imagery file sizes to transmit usable images in as short a time as possible. Remember that the average image size used in the tactical intelligence community is around 4 megabytes (MB). Transmission time over a T1 line is 4 minutes, but over a regular telephone line at 9,600 bits per second (bps), the transmission time goes up to 55 minutes. If we compress the image by 50 percent, or a 2:1 compression ratio, it will take only one-half the time (see figure J-1). Note that the times are still excessive for our original 4 MB image until around the 25:1 compression point for the 2,400 and 9,600 rates.

Mode 1 52:1 (.15 bits per pixel)	Mode 2 67:1 (.11 bits per pixel)	Mode 3 59:1 (.13 bits per pixel)
--	--	--

Figure J-1. Bi-Level Image Compression Results.

The first NITF algorithm that will be addressed is the Joint Photographic Experts Group (JPEG) image compression algorithm. The complete specifications are contained in MIL-STD-188-198A.

JPEG is one of the most popular and widely used compression algorithms. It is used on the World Wide Web and was adapted for use in the NITF in the early 1990s.

NITF JPEG also follows a model similar to those discussed previously to produce a compressed image. NITF JPEG's Forward Discrete Cosine Transform (FDCT) is just another mathematical formula. JPEG divides the image into 8 by 8-minimum coding units or neighborhoods, and then calculates the FDCT of each neighborhood. The quantizer rounds off or smooths the FDCT coefficients according to the table specifications, and then is encoded.

For decompression, JPEG recovers the quantized FDCT coefficients from the compressed data stream, takes the inverse transform (using embedded tables), and displays the image. This is a simple description; technical details are in the military standard. We need to know two things: How the various Q settings impact the quality of an image, and the time available to transmit the compressed image.

NITF JPEG provides several variants, Discrete Cosine Transform (DCT) lossy (8 and 12 bit), downsample JPEG, and lossless.

APPENDIX K. IMAGERY INTELLIGENCE

APPENDIX FORMAT

The IMINT operations appendix should explain how IMINT and relevant imagery-related elements under the OPCON or supporting the MAGTF will be used to support this plan. It

should also provide guidance to subordinate commanders for the conduct of IMINT operations and the support of IMINT elements and personnel identified to fulfill the IMINT requirements.

CLASSIFICATION

Copy no. ___ of ___ copies
ISSUING UNIT
PLACE OF ISSUE
Date/time group
Message reference number

APPENDIX 7 TO ANNEX B (INTELLIGENCE) TO MAGTF OPORD XXX (U) Imagery Intelligence (U)

(U) REFERENCES: Identify DOD, NIMA, and other directives; combatant commander, JTF or other higher authorities' operations orders and tactics, techniques and procedures or SOP for intelligence and IMINT operations; pertinent maps and other geospatial information resources; and any other relevant references that pertain to anticipated IMINT operations.

1. (U) Situation

a. (U) Definition of the Area of Operations (AO) and Area of Interest (AOI). Describe the limits of the AO and AOI. Summarize pertinent weather, terrain and other AO's characteristics and conditions that may influence the conduct of IMINT operations.

b. (U) Enemy. Refer to Annex B and current intelligence estimates for threat capabilities, limitations, vulnerabilities, and OOB pertinent to IMINT operations.

c. (U) Assigned MAGTF Organic and Supporting IMINT Assets. Identify organic and supporting forces available to perform IMINT and imagery-related functions.

Page number

CLASSIFICATION

CLASSIFICATION

- d. (U) Facts and Assumptions. Derived during the mission analysis step of the MCPP.
- e. (U) IMINT Considerations. List key IMINT, intelligence or other considerations that impact this OPLAN or CONPLAN.
- (1) (U) Availability of national source and commercial imagery.
 - (2) (U) IMINT support to and from JTF and other component headquarters.
 - (3) (U) Creation and manning of forward IMINT elements.
2. (U) Mission. State concisely the IMINT mission as it relates to the command's planned operation.
3. (U) Execution
- a. (U) Concept of Operations. Reference the unit's intelligence SOP and Appendix 16 (Intelligence Operations Plan) to Annex B. Restate as appropriate the commander's intent and pertinent aspects of the unit's overall concept of operations as they relate to IMINT operations. Outline the purpose and concept of IMINT operations, specified priorities, and summarize the means and agencies to be employed in planning and directing, collecting, processing and exploiting, analyzing and producing, disseminating, and using IMINT during execution of the OPORD. Address the integration of JTF, other components, theater, national, and allied forces' IMINT operations.
 - b. (U) Tasks for IMINT and Related Units and Organizations, Subordinate Units, and Task Force Commanders/OICs.
- (1) (U) Orders to Subordinate, Attached and Supporting Units. Use separate numbered subparagraphs to list detailed instructions for each unit conducting IMINT operations, including the originating headquarters, subordinate commands, and separate intelligence support units.
 - (a) (U) Major Subordinate Commanders
 - (b) (U) Commanding Officer, Intel Bn
 - 1 Platoon Commander, Imagery Intelligence Platoon
 - 2 OIC, JSTARS Common Ground Station Section

Page number

CLASSIFICATION

CLASSIFICATION

- 3 SNCOICs, Direct Support Teams
 - 4 OIC, Support Cell
 - 5 OIC, Surveillance and Reconnaissance Cell
 - 6 OIC, Production and Analysis Cell
 - 7 (Others as appropriate)
- (c) (U) Commanding Officer, VMU Squadron
 - (d) (U) Commanding Officer, Force Reconnaissance Company
- (2) (U) Requests to Higher, Adjacent, and Cooperating Units. Provide separate numbered subparagraphs pertaining to each unit not organic, attached or supporting and from which IMINT support is requested, including other components, JTF headquarters, allied or coalition forces, theater and national operational and intelligence elements.
- c. (U) Coordinating Instructions. (Reference Appendix 16 (Intelligence Operations Plan), and command and other pertinent forces and organizations intelligence and CI SOPs. Detail here or in supporting tabs key changes to SOPs. Additional topics to include or emphasize here are requesting IMINT support; direct liaison among subordinate commanders, MAGTF IMINT units, staff officers, and pertinent external organizations and agencies; routine and time-sensitive reporting procedures and formats, etc.)
4. (U) Administration and Logistics
- a. (U) Logistics. Reference Annex D (Logistics). Identify IMINT unique logistic requirements and concerns, such as: any unique combat service support requirements, procedures, and other guidance to support MAGTF IMINT units and operations; or procedures for specialized technical logistic support necessary from external organizations.
 - b. (U) Personnel. Identify intelligence unique IMINT personnel requirements and concerns.
5. (U) Command and Control
- a. (U) Command Relationships. Reference Annex J (Command Relationships). Provide any instructions necessary regarding MAGTF command relationships that will influence unit IMINT operations.

CLASSIFICATION

- b. (U) Information Management. Reference Annex U (Information Management), Annex C (Operations) and Appendix 16 (Intelligence Operations Plan). Provide any instructions necessary regarding information management (time-sensitive and routine reporting criteria, intelligence databases, reports, etc.) that will influence MAGTF IMINT operations.
- c. (U) Communications and Information Systems. Reference Appendix 16 (Intelligence Operations Plan) and Annex K (Communications and Information Systems). Provide any instructions necessary regarding CIS that will influence MAGTF IMINT operations.
- d. (U) Intelligence C2 Nodes and Facilities. Reference the unit's intelligence SOP and Appendix 16 (Intelligence Operations Plan). Provide guidance and instructions necessary regarding the establishment and operations of intelligence and IMINT C2 nodes and facilities (e.g., the surveillance and reconnaissance cell).

TABS: (As necessary)

APPENDIX L. UNMANNED AERIAL VEHICLE PLAN FORMAT

CLASSIFICATION

Copy no. _____ of _____ copies

ISSUING UNIT

PLACE OF ISSUE

Date/time group

Message reference number

TAB C TO APPENDIX 14 TO ANNEX B TO OPLAN XXX UNMANNED AERIAL VEHICLE PLAN

(U) REFERENCES: (As appropriate)

1. (U) Mission. Conduct real-time surveillance, target acquisition, and imagery intelligence throughout the MAGTF area of responsibility until termination of hostilities, per Annex B (Intelligence) and Annex C (Operations) to the MAGTF OPLAN.
2. (U) Execution. The UAV squadron will provide UAVs and C2 crews in support of MAGTF operations. The MAGTF G-2, in coordination with the G-3, will exercise operational control of all tactical surveillance UAVs within the AO unless otherwise directed. The ISC, under the staff cognizance of the AC/S G-2, plans, coordinates, and supervises MAGTF UAV intelligence missions.
3. (U) Tasks. Detachment, _____, _____ UAV Squadron will—
 - a. (U) Prepare a UAV employment plan and overlay to depict the UAV's concept of employment supporting combat operations ashore and submit these to the MAGTF G-2 (Attn: ISC or CMDO).
 - b. (U) Assign surveillance UAV equipment, and personnel to provide real-time video/imagery intelligence in support of MAGTF operations as directed by Annex B (Intelligence) to the MAGTF OPLAN, daily ATOs, and other intelligence orders.
 - c. (U) Provide RRS detachments at designated locations afloat and ashore.
 - d. (U) Initiate action to obtain approved frequencies for UAV support, per Annex K (CIS) to the MAGTF OPLAN.

Page number

CLASSIFICATION

CLASSIFICATION

- e. (U) Coordinate flight operations through appropriate air control agencies as assigned in Annex N (Aviation Operations) to the MAGTF OPLAN.
- 4. (U) MAGTF UAV Surveillance Sectors/Routes. To facilitate the assignment and coordination of tactical surveillance missions, UAV loiter areas and surveillance routes are designated in the enclosures to this tab.

ENCLOSURES:

- 1 —UAV Employment Plan
- 2 —UAV Employment Overlay

CLASSIFICATION

Copy no. _____ of _____ copies
 ISSUING UNIT
 PLACE OF ISSUE
 Date/time group
 Message reference number

ENCLOSURE 1 TO TAB C TO APPENDIX 14 TO ANNEX B TO
 OPLAN XXX UAV EMPLOYMENT PLAN

(U) REFERENCES: (a) Maps: NIMA stock no. _____

The following UAV and surveillance routes, targets, and loiter areas have been preplanned in support of MAGTF operations:

MSN NUMBER	COORDINATES	ALT	TOT	FOOTNOTES
	_____to	TBD	TBD	
	_____to			
	_____to			
	_____to			
	close			
	_____to	TBD	TBD	
	_____to			
	_____to			
	_____to			
	close			

*Note: (1) Tasked intelligence requirements and reporting criteria.
 (2) (Others as appropriate)*

Page number

CLASSIFICATION

APPENDIX M. AERIAL IMAGERY PLAN FORMAT

CLASSIFICATION

Copy no. ___ of ___ copies
 ISSUING UNIT
 PLACE OF ISSUE
 Date/time group
 Message reference number

TAB D TO APPENDIX 14 TO ANNEX B TO OPLAN XXX AERIAL IMAGERY PLAN

(U) REFERENCES: (a) Maps. See appendix 15 (Geographic Intelligence) to Annex B (Intelligence) and Annex M (Geospatial Information and Services)

1. The following aerial imagery missions have been preplanned.

MSN NO.	COORD	PHOTO			SLR MODE	IR/ALT	DATE OF MSN	REMARKS
		VERT OR OBL	OVER-LAP	FILM SCALE				
1.	XXXX	VERT	60%	B&W	Low	N/A	D-30	Basic Coverage
	XXXX		FOR	1:20K	ALT			
	XXXX		40%		Mode			
	XXXX				10B			
2.	XXXX	VERT	60%	B&W	Low	D-3 only	D-1	Beach Study Survey
	XXXX		FOR	Color	ALT			
	XXXX		40%	& CD	MTIR			
	XXXX		SIDE	1:5K	or MTIR			
3.	N/A	N/A	N/A	N/A	N/A	N/A	D+1	On call

Page number

CLASSIFICATION

APPENDIX N. GLOSSARY

SECTION I. ACRONYMS

AAA	antiaircraft artillery		
ACE	aviation combat element		
ADCON	administrative control		
AFC	all-source fusion center		
AGL	above ground level		
AMC	air mission commander		
AO	area of operations		
AOI	area of interest		
ATARS	advanced tactical airborne reconnaissance system		
ATF	amphibious task force		
ATO	air tasking order		
AVN	aviation department HQMC		
AW	all weather		
			materials system
		CO	commanding officer
		COA	course of action
		COC	current operations center
		COLISEUM	Community On-Line Intelligence System for End-Users and Managers
		CONPLAN	concept plan
		COP	common operational picture
		COTS	commercial off-the-shelf
		CSRT	customer support response team
		CSS	combat service support
		CSSD	combat service support detachment
		CSSE	combat service support element
		CTP	common tactical picture
		CVBG	carrier battle group
		DASC	direct air support center
		DATEDES	date desired
		DCI	Director of Central Intelligence
		DCT	discrete cosine transform
		DE	dissemination element
		DIA	Defense Intelligence Agency
		DISN	defense information systems network
		DMRF	denominator of the map representative factor
		DMS	defense message system
		DOD	Department of Defense
		DODIPP	Department of Defense Intelligence Production Program
		DPL	digital photo lab
		DPRF	denominator of the photo representative factor
		DRO	Departmental Requirements Officer
		DS	downsample
		DSA	directed search area
		DSCS	defense satellite communications system
		DSN	defense switched network
		DSSCS	defense special security communications system
		EO	electro-optical

E&R	evasion and recovery	ISC	intelligence support coordinator
EW	electronic warfare	JAC	joint analysis center
5D	demand driven direct digital dissemination	JDISS	joint deployable intelligence support system
FDCT	forward discrete cosine transform	JFACC	joint force air component commander
FLIR	forward-looking infrared	JFC	joint force commander
FSCC.....	fire support coordination center	JFLCC.....	joint force land component commander
FSSG.....	force service support group	JFMCC	joint force maritime component commander
FTI	fixed target indicator	JIC.....	joint intelligence center
GB.....	gigabytes	JISE.....	joint intelligence support element
GCCS	global command and control system	JOPES.....	Joint Operation Planning and Execution System
GCE	ground combat element	JPEG	joint photographic experts group
GCS.....	ground control station	JSIPS.....	Joint Services Imagery Processing System
GD.....	ground distance	JSTARS	joint surveillance, target attack radar system
GDT	ground data terminal	JTAR/S	joint tactical air reconnaissance/surveillance
GENSER.....	general service	JTF	joint task force
GEOINT	geographic intelligence	JWICS.....	Joint Worldwide Intelligence Communications System
GRG	gridded reference graphic	kbps.....	kilobytes per second
GSP.....	ground sensor platoon	kw	kilowatt
HD.....	horizontal distance	LAN	local area network
HML/A	Marine light/attack helicopter squadron	LAR	light armored reconnaissance
HQMC	Headquarters Marine Corps	LEADS	location, elevation, accuracy, datum, source
HUMINT	human intelligence	LF	landing force
I&W	indications and warning	LOC	lines of communications
IA	imagery analyst	LOS.....	line of sight
IAS	intelligence analysis system	LP	landing point
ICR	intelligence collection requirement	LTIOV	latest time intelligence is of value
IDR	intelligence dissemination requirement	MACCS	Marine air command and control system
IESS	imagery exploitation software system	MACG	Marine air control group
IIP	imagery intelligence platoon	MAG.....	Marine aircraft group
IMINT.....	imagery intelligence	MAGTF	Marine air-ground task force
INMARSAT	international maritime satellite system	MASINT.....	measurement and signature intelligence
intel bn	intelligence battalion	mbps	megabits per second
IOC	intelligence operations center		
IPB	intelligence preparation of the battlespace		
IPIR.....	initial photo interpretation report		
IPL	imagery product library		
IPR	intelligence production requirement		
IR	intelligence requirement		

Manpack SIDS	man packable secondary imagery dissemination system	P&A	production and analysis
MARCORSYSCOM.	Marine Corps Systems Command	PCMCIA	Personal Computer Memory Card International Association
MARFOR	Marine Corps forces	PCS	portable control station
MARFORRES	Marine Corps Forces Reserve	PD	photo distance
MAW	Marine aircraft wing	PI	photo interpreter
MB	megabyte	PIR	priority intelligence requirement
MCCDC	Marine Corps Combat Development Command	POL	petroleum, oils, and lubricants
MCIA	Marine Corps Intelligence Activity	PT	primary target
MD	map distance	QRS	quick response system
MEF	Marine expeditionary force	R&S	reconnaissance and surveillance
MEU(SOC)	Marine expeditionary unit (special operations capable)	RAOC	rear area operations center
MHG	MEF headquarters group	RATO	rocket-assisted takeoff
mi	miles	RECCEXREP	reconnaissance exploitation report
MIPIR	multimission imagery photo interpretation report	RFI	request for intelligence
MOS	military occupational specialty	RMS	requirements management system
MSC	major subordinate command	ROC	reconnaissance operations center
MSI	multispectral imagery	RP	reference point
MSL	mean sea level	RRS	remote receive station
MTI	moving target indicator	RS	receive segment
MWSS	Marine wing support squadron	RVT	remote video terminal
NAI	named area of interest	SACC	supporting arms coordination center
NDS	NIMA delivery system	SAFE	selected area for evasion
NIIRS	National Imagery Interpretability Rating Scale	SAM	surface-to-air missile
NIMA	National Imagery and Mapping Agency	SAID	SAFE area intelligence description
NIPRNET	Nonsecure Internet Protocol Router Network	SAR	synthetic aperture radar
NIST	national intelligence support team	SARC	surveillance and reconnaissance cell
NITF	national imagery transmission format	SATCOM	satellite communications
NRO	National Reconnaissance Office	SCDL	surveillance and control data link
NRT	near-real-time	SCI	sensitive compartmented information
NSA	National Security Agency	SCR	single channel radio
NTIS	night thermal imaging system	SERE	survival, evasion, resistance, and escape
NTS	night targeting system	SGS	squadron ground station
OIC	officer in charge	SHF	super high frequency
OOB	order of battle	SI	special intelligence
OPCON	operational control	SIDS	secondary imagery dissemination system
		SIG	sensor interface group

SIGINT	signals intelligence	TRAP	tactical recovery of aircraft and personnel
SIPRNET	SECRET Internet Protocol Router Network	TTP	tactics, techniques, and procedures
SL	slope	TUAV	tactical unmanned aerial vehicle
SOP	standing operating procedure	UAV	unmanned aerial vehicle
SR	short range	UHF	ultrahigh frequency
STOM	ship to objective maneuver	VCR	videocassette recorder
SVCR	super videocassette recorder	VD	vertical distance
TACC	tactical air command center	VHS	very high speed
TACPHOTO	tactical intelligence photographic capability	VMFA(AW)	Marine fighter/attack (all weather) squadron
TARPS	tactical airborne reconnaissance pod system	VMU	Marine unmanned aerial vehicle squadron
TCU	tracking control unit	VRN	vehicle registration number
TDI	target data inventory	WAN	wide area network
TDN	tactical data network	WG	workstation group
TEG	tactical exploitation group	WICP	wing initial communications package
TIGDL	tactical interoperable ground data link		
T/O	table of organization		
TOT	time over target		

SECTION II. DEFINITIONS

administrative control—Direction or exercise of authority over subordinate or other organizations in respect to administration and support, including organization of Service forces, control of resources and equipment, personnel management, unit logistics, individual and unit training, readiness, mobilization, demobilization, discipline, and other matters not included in the operational missions of the subordinate or other organizations. Also called ADCON. (JP 1-02)

air contingency MAGTF—An on-call, combat-ready MAGTF that deploys by airlift. Air contingency MAGTFs vary in size based on mission requirements and the availability of airlift. Because they deploy by air, they generally have a limited organic logistics capability, and require an arrival airfield. Air contingency MAGTFs usually are activated to respond to developing crises, and may deploy independently or in conjunction with other expeditionary forces. Also called ACM.

all-source intelligence—**1.** Intelligence products and/or organizations and activities that incorporate all sources of information, most frequently including human resources intelligence, imagery intelligence, measurement and signature intelligence, signals intelligence, and open-source data, in the production of finished intelligence. **2.** In intelligence collection, a phrase that indicates that in the satisfaction of intelligence requirements, all collection, processing, exploitation, and reporting systems and resources are identified for possible use and those most capable are tasked. (JP 1-02)

area of interest—That area of concern to the commander, including the area of influence, areas adjacent thereto, and extending into enemy territory to the objectives of current or planned operations. This area also includes areas occupied by enemy forces who could jeopardize the accomplishment of the mission. Also called AOI. (JP 1-02)

area of operations—An operational area defined by the joint force commander for land and naval forces. Areas of operation do not typically encompass the entire operational area of the joint force commander, but should be large enough for component commanders to accomplish their missions and protect their forces. Also called AO. (JP 1-02)

assessment—**1.** Analysis of the security, effectiveness, and potential of an existing or planned intelligence activity. **2.** Judgment of the motives, qualifications, and characteristics of present or prospective employees or “agents.” (JP 1-02)

attach—**1.** The placement of units or personnel in an organization where such placement is relatively temporary. **2.** The detailing of individuals to specific functions where such functions are secondary or relatively temporary, e.g., attached for quarters and rations; attached for flying duty. (JP 1-02)

aviation combat element—The core element of a Marine air-ground task force (MAGTF) that is task-organized to conduct aviation operations. The aviation combat element (ACE) provides all or a portion of the six functions of Marine aviation necessary to accomplish the MAGTF’s mission. These functions are antiair warfare, offensive air support, assault support, electronic warfare, air reconnaissance, and control of aircraft and missiles. The ACE is usually composed of an aviation unit headquarters and various other aviation units or their detachments. It can vary in size from a small aviation detachment of specifically required aircraft to one or more Marine aircraft wings. The ACE itself is not a formal command. Also called ACE. (JP 1-02)

basic intelligence—Fundamental intelligence concerning the general situation, resources, capabilities, and vulnerabilities of foreign countries or areas which may be used as reference material in the planning of operations at any level and in

evaluating subsequent information relating to the same subject. (JP 1-02)

battle damage assessment—The timely and accurate estimate of damage resulting from the application of military force, either lethal or non-lethal, against a predetermined objective. Battle damage assessment can be applied to the employment of all types of weapon systems (air, ground, naval, and special forces weapon systems) throughout the range of military operations. Battle damage assessment is primarily an intelligence responsibility with required inputs and coordination from the operators. Battle damage assessment is composed of physical damage assessment, functional damage assessment, and target system assessment. Also called BDA. (JP 1-02) In Marine Corps usage, the timely and accurate estimate of the damage resulting from the application of military force. BDA estimates physical damage to a particular target, functional damage to that target, and the capability of the entire target system to continue its operations. (MCRP 5-12C)

battlespace—The environment, factors, and conditions that must be understood to successfully apply combat power, protect the force, or complete the mission. This includes the air, land, sea, space, and the included enemy and friendly forces; facilities; weather; terrain; the electromagnetic spectrum; and the information environment within the operational areas and areas of interest. (JP 1-02)

battlespace dominance—The degree of control over the dimensions of the battlespace which enhances friendly freedom of action and denies enemy freedom of action. It permits force sustainment and application of power projection to accomplish the full range of potential operational and tactical missions. It includes all actions conducted against enemy capabilities to influence future operations. (MCRP 5-12C)

beach—**1.**The area extending from the shoreline inland to a marked change in physiographic form or

material or to the line of permanent vegetation (coastline). **2.** In amphibious operations, that portion of the shoreline designated for landing of a tactical organization. (JP 1-02)

beachhead—A designated area on a hostile or potentially hostile shore that, when seized and held, ensures the continuous landing of troops and materiel, and provides maneuver space requisite for subsequent projected operations ashore. (JP 1-02)

beach landing site—A geographic location selected for across-the-beach infiltration, exfiltration or resupply operations. Also called BLS. (JP 1-02)

beach width—The horizontal dimensions of the beach measured at right angles to the shoreline from the line of extreme low water inland to the landward limit of the beach (the coastline). (JP 1-02)

centers of gravity—Those characteristics, capabilities, or sources of power from which a military force derives its freedom of action, physical strength, or will to fight. (JP 1-02)

centralized control—In military operations, a mode of battlespace management in which one echelon of command exercises total authority and direction of all aspects of one or more warfighting functions. It is a method of control where detailed orders are issued and total unity of action is the overriding consideration. (MCRP 5-12C)

collection (acquisition)—The obtaining of information in any manner, including direct observation, liaison with official agencies, or solicitation from official, unofficial, or public sources. (JP 1-02) In Marine Corps usage, the gathering of intelligence data and information to satisfy the identified requirements. (MCRP 5-12C)

collection agency—Any individual, organization or unit that has access to sources of information and the capability of collecting information from them. (JP 1-02)

collection management—In intelligence usage, the process of converting intelligence requirements into collection requirements, establishing priorities, tasking or coordinating with appropriate collection sources or agencies, monitoring results, and retasking, as required. (JP 1-02)

collection plan—A plan for collecting information from all available sources to meet intelligence requirements and for transforming those requirements into orders and requests to appropriate agencies. (JP 1-02)

collection requirement—An established intelligence need considered in the allocation of intelligence resources to fulfill the essential elements of information and other intelligence needs of a commander. (JP 1-02)

combatant command—A unified or specified command with a broad continuing mission under a single commander established and so designated by the President, through the Secretary of Defense and with the advice and assistance of the Chairman of the Joint Chiefs of Staff. Combatant commands typically have geographic or functional responsibilities. (JP 1-02)

combat data—Data derived from reporting by operational units. (MCRP 5-12C)

combat service support element—The core element of a Marine air-ground task force that is task-organized to provide the combat service support necessary to accomplish the Marine air-ground task force mission. The combat service support element varies in size from a small detachment to one or more force service support groups. It provides supply, maintenance, transportation, general engineering, health services, and a variety of other services to the Marine air-ground task force. It may also contain other Service or foreign military forces assigned or attached to the MAGTF. The combat service support element itself is not a formal command. Also called CSSE. (Approved for inclusion in next edition of MCRP 5-12C)

combat surveillance—A continuous, all-weather, day-and-night, systematic watch over the battle area in order to provide timely information for tactical combat operations. (JP 1-02)

command and control—The exercise of authority and direction by a properly designated commander over assigned and attached forces in the accomplishment of the mission. Command and control functions are performed through an arrangement of personnel, equipment, communications, facilities, and procedures employed by a commander in planning, directing, coordinating, and controlling forces and operations in the accomplishment of the mission. Also called C2. (JP 1-02) Also in Marine Corps usage, the means by which a commander recognizes what needs to be done and sees to it that appropriate actions are taken. (MCRP 5-12C)

command element—The core element of a Marine air-ground task force that is the headquarters. The command element is composed of the commander, general or executive and special staff sections, headquarters section, and requisite communications support, intelligence and reconnaissance forces, necessary to accomplish the MAGTF's mission. The command element provides command and control, intelligence, and other support essential for effective planning and execution of operations by the other elements of the MAGTF. The command element varies in size and composition. Also called CE. (JP 1-02)

commander's critical information requirements—A comprehensive list of information requirements identified by the commander as being critical in facilitating timely information management and the decisionmaking process that affect successful mission accomplishment. The two key subcomponents are critical friendly force information and priority intelligence requirements. (JP 1-02) Information regarding the enemy and friendly activities and the environment identified by the commander as critical to maintaining situational awareness, planning future activities, and facilitating timely decisionmaking. Also called CCIR.

NOTE: CCIRs are normally divided into three primary subcategories: priority intelligence requirements; friendly force information requirements; and essential elements of friendly information. (MCRP 5-12C)

commander's intent—A commander's clear, concise articulation of the purpose(s) behind one or more tasks assigned to a subordinate. It is one of two parts of every mission statement which guides the exercise of initiative in the absence of instructions. (MCRP 5-12C)

contingency—An emergency involving military forces caused by natural disasters, terrorists, subversives, or by required military operations. Due to the uncertainty of the situation, contingencies require plans, rapid response, and special procedures to ensure the safety and readiness of personnel, installations, and equipment. (JP 1-02)

control—**1.** Authority which may be less than full command exercised by a commander over part of the activities of subordinate or other organizations. **2.** In mapping, charting, and photogrammetry, a collective term for a system of marks or objects on the earth or on a map or a photograph, whose positions or elevations or both, have been or will be determined. **3.** Physical or psychological pressures exerted with the intent to assure that an agent or group will respond as directed. **4.** An indicator governing the distribution and use of documents, information, or material. Such indicators are the subject of intelligence community agreement and are specifically defined in appropriate regulations. (JP 1-02)

coordinating authority—A commander or individual assigned responsibility for coordinating specific functions or activities involving forces of two or more Military Departments or two or more forces of the same Service. The commander or individual has the authority to require consultation between the agencies involved, but does not have the authority to compel agreement. In the event that essential agreement cannot be obtained, the matter shall be referred to the appointing authority. Coordinating

authority is a consultation relationship, not an authority through which command may be exercised. Coordinating authority is more applicable to planning and similar activities than to operations. (JP 1-02)

coordination—The action necessary to ensure adequately integrated relationships between separate organizations located in the same area. Coordination may include such matters as fire support, emergency defense measures, area intelligence, and other situations in which coordination is considered necessary. (MCRP 5-12C)

counterintelligence—**1.** Information gathered and activities conducted to protect against espionage, other intelligence activities, sabotage or assassinations conducted by or on behalf of foreign governments or elements thereof, foreign organizations or foreign persons or international terrorist activities. Also called CI. See also counterespionage; security. (JP 1-02) **2.** Within the Marine Corps, counterintelligence (CI) constitutes active and passive measures intended to deny a threat force valuable information about the friendly situation, to detect and neutralize hostile intelligence collection, and to deceive the enemy as to friendly capabilities and intentions. (MCRP 5-12C)

countermeasures—That form of military science that, by the employment of devices and/or techniques, has as its objective the impairment of the operational effectiveness of enemy activity. (JP 1-02)

critical vulnerability—An aspect of a center of gravity that if exploited will do the most significant damage to an adversary's ability to resist. A vulnerability cannot be critical unless it undermines a key strength. Also called CV. (MCRP 5-12C)

current intelligence—One of two categories of descriptive intelligence that is concerned with describing the existing situation. (JP 1-02)

damage assessment—**1.** The determination of the effect of attacks on targets. **2.** A determination of

the effect of a compromise of classified information on national security. (JP 1-02)

decentralized control—In military operations, a mode of battlespace management in which a command echelon may delegate some or all authority and direction for warfighting functions to subordinates. It requires careful and clear articulation of mission, intent, and main effort to unify efforts of subordinate leaders. (MCRP 5-12C)

descriptive intelligence—Class of intelligence which describes existing and previously existing conditions with the intent to promote situational awareness. Descriptive intelligence has two components: basic intelligence, which is general background knowledge about established and relatively constant conditions; and current intelligence, which is concerned with describing the existing situation. (MCRP 5-12C)

detachment—**1.** A part of a unit separated from its main organization for duty elsewhere. **2.** A temporary military or naval unit formed from other units or parts of units. (JP 1-02)

dissemination—Conveyance of intelligence to users in a suitable form. (JP 1-02)

dissemination management—Involves establishing dissemination priorities, selection of dissemination means, and monitoring the flow of intelligence throughout the command. The objective of dissemination management is to deliver the required intelligence to the appropriate user in proper form at the right time while ensuring that individual consumers and the dissemination system are not overloaded attempting to move unneeded or irrelevant information. Dissemination management also provides for use of security controls which do not impede the timely delivery or subsequent use of intelligence while protecting intelligence sources and methods. (MCRP 5-12C)

drop zone—A specific area upon which airborne troops, equipment or supplies are airdropped. (JP 1-02)

essential elements of friendly information—Key questions likely to be asked by adversary officials and intelligence systems about specific friendly intentions, capabilities, and activities so they can obtain answers critical to their operational effectiveness. Also called EEFI. (JP 1-02) Specific facts about friendly intentions, capabilities, and activities needed by adversaries to plan and execute effective operations against our forces. (MCRP 5-12C)

estimative intelligence—Class of intelligence which attempts to anticipate future possibilities and probabilities based on an analysis of descriptive intelligence in the context of planned friendly and assessed enemy operations. (MCRP 5-12C)

evasion and escape intelligence—Processed information prepared to assist personnel to escape if captured by the enemy or to evade capture if lost in enemy-dominated territory. (JP 1-02)

executive agent—A term used in DOD and Service regulations to indicate a delegation of authority by a superior to a subordinate to act on behalf of the superior. An agreement between equals does not create an executive agent. For example, a Service cannot become a DOD Executive Agent for a particular matter with simply the agreement of the other Services; such authority must be delegated by the Secretary of Defense. Designation as executive agent, in and of itself, confers no authority. The exact nature and scope of the authority delegated must be stated in the document designating the executive agent. An executive agent may be limited to providing only administration and support or coordinating common functions or it may be delegated authority, direction, and control over specified resources for specified purposes. (JP1-02)

force protection—Actions taken to prevent or mitigate hostile actions against Department of Defense personnel (to include family members), resources, facilities, and critical information. These actions conserve the force's fighting potential so it can be applied at the decisive time and place and incorporate the coordinated and synchronized offensive and defensive measures to

enable the effective employment of the joint force while degrading opportunities for the enemy. Force protection does not include actions to defeat the enemy or protect against accidents, weather, or disease. (JP 1-02)

friendly force information requirements—Information the commander needs about friendly forces in order to develop plans and make effective decisions. Depending upon the circumstances, information on unit location, composition, readiness, personnel status, and logistics status could become a friendly force information requirement. Also called FFIR. (MCRP 5-12C)

fusion—In intelligence usage, the process of examining all sources of intelligence and information to derive a complete assessment of activity. (JP 1-02)

global sourcing—A process of force provision or augmentation whereby resources may be drawn from any location/command worldwide. (MCRP 5-12C)

ground combat element—The core element of a Marine air-ground task force that is task-organized to conduct ground operations. It is usually constructed around an infantry organization but can vary in size from a small ground unit of any type, to one or more Marine divisions that can be independently maneuvered under the direction of the MAGTF commander. The ground combat element itself is not a formal command. Also called GCE. (JP 1-02)

helicopter landing zone—A specified ground area for landing assault helicopters to embark or disembark troops and/or cargo. A landing zone may contain one or more landing sites. (JP 1-02)

high-payoff target—A target whose loss to the enemy will significantly contribute to the success of the friendly course of action. High-payoff targets are those high-value targets, identified through war-gaming, which must be acquired and successfully attacked for the success of the friendly commander's mission. Also called HPT. (JP 1-02)

high-value target—A target the enemy commander requires for the successful completion of the mission. The loss of high-value targets would be expected to seriously degrade important enemy functions throughout the friendly commander's area of interest. Also called HVT. (JP 1-02)

human intelligence—A category of intelligence derived from information collected and provided by human resources. Also called HUMINT. (JP 1-02) In Marine Corps usage, HUMINT operations cover a wide range of activities encompassing reconnaissance patrols, aircrew reports and debriefs, debriefing of refugees, interrogations of prisoners of war, and the conduct of CI force protection source operations. (MCRP 5-12C)

imagery—Collectively, the representations of objects reproduced electronically or by optical means on film, electronic display devices or other media. (JP 1-02)

imagery exploitation—The cycle of processing and printing imagery to the positive or negative state, assembly into imagery packs, identification, interpretation, mensuration, information extraction, the preparation of reports, and the dissemination of information. (JP 1-02)

imagery intelligence—Intelligence derived from the exploitation of collection by visual photography, infrared sensors, lasers, electro-optics, and radar sensors such as synthetic aperture radar wherein images of objects are reproduced optically or electronically on film, electronic display devices or other media. Also called IMINT. (JP 1-02)

imagery interpretation—**1.** The process of location, recognition, identification, and description of objects, activities, and terrain represented on imagery. (NATO) **2.** The extraction of information from photographs or other recorded images. Also called interpretation. (JP 1-02)

indications and warning—Those intelligence activities intended to detect and report time-sensitive intelligence information on foreign developments that could involve a threat to the United States or allied and/or coalition military, political,

or economic interests or to U.S. citizens abroad. It includes forewarning of enemy actions or intentions; the imminence of hostilities; insurgency; nuclear or non-nuclear attack on the United States, its overseas forces, or allied and/or coalition nations; hostile reactions to United States reconnaissance activities; terrorists' attacks; and other similar events. Also called I&W. (JP 1-02)

indications (intelligence)—Information in various degrees of evaluation, all of which bears on the intention of a potential enemy to adopt or reject a course of action. (JP 1-02)

indicator—In intelligence usage, an item of information which reflects the intention or capability of a potential enemy to adopt or reject a course of action. (JP 1-02)

information—**1.** Facts, data, or instructions in any medium or form. **2.** The meaning that a human assigns to data by means of the known conventions used in their representation. (JP 1-02)

information exchange requirement—The requirement for information to be passed between and among forces, organizations, or administrative structures concerning ongoing activities. Information exchange requirements identify who exchanges what information with whom, as well as why the information is necessary and how that information will be used. The quality (i.e., frequency, timeliness, security) and quantity (i.e., volume, speed, and type of information such as data, voice, and video) are attributes of the information exchange included in the information exchange requirement. Also called IER. (MCRP 5-12C)

infrared imagery—That imagery produced as a result of sensing electromagnetic radiations emitted or reflected from a given target surface in the infrared position of the electromagnetic spectrum (approximately 0.72 to 1,000 microns). (JP 1-02)

integration—**1.** A stage in the intelligence cycle in which a pattern is formed through the selection and combination of evaluated information. **2.** In photography, a process by which the average radar picture seen on several scans of the time

base may be obtained on a print or the process by which several photographic images are combined into a single image. (JP 1-02)

intelligence—**1.** The product resulting from the collection, processing, integration, analysis, evaluation, and interpretation of available information concerning foreign countries or areas. **2.** Information and knowledge about an adversary obtained through observation, investigation, analysis, or understanding. (JP 1-02) Also in Marine Corps usage, intelligence is knowledge about the enemy or the surrounding environment needed to support decisionmaking. This knowledge is the result of the collection, processing, exploitation, evaluation, integration, analysis, and interpretation of available information about the battlespace and threat. (MCRP 5-12C)

intelligence data—Data derived from assets primarily dedicated to intelligence collection such as imagery systems, electronic intercept equipment, human intelligence sources, etc. (MCRP 5-12C)

intelligence discipline—A well defined area of intelligence collection, processing, exploitation, and reporting using a specific category of technical or human resources. There are seven major disciplines: human intelligence, imagery intelligence, measurement and signature intelligence, signals intelligence (communications intelligence, electronic intelligence, and foreign instrumentation signals intelligence), open-source intelligence, technical intelligence, and counterintelligence. (JP 1-02)

intelligence estimate—The appraisal, expressed in writing or orally, of available intelligence relating to a specific situation or condition with a view to determining the courses of action open to the enemy or potential enemy and the order of probability of their adoption. (JP 1-02)

intelligence preparation of the battlespace—An analytical methodology employed to reduce uncertainties concerning the enemy, environment, and terrain for all types of operations. Intelligence preparation of the battlespace builds an extensive

database for each potential area in which a unit may be required to operate. The database is then analyzed in detail to determine the impact of the enemy, environment, and terrain on operations and presents it in graphic form. Intelligence preparation of the battlespace is a continuing process. Also called IPB. (JP 1-02) In Marine Corps usage, the systematic, continuous process of analyzing the threat and environment in a specific geographic area. (MCRP 5-12C)

intelligence-related activities—Those activities outside the consolidated defense intelligence program that: respond to operational commanders' tasking for time-sensitive information on foreign entities; respond to national intelligence community tasking of systems whose primary mission is support to operating forces; train personnel for intelligence duties; provide an intelligence reserve; or are devoted to research and development of intelligence or related capabilities. (Specifically excluded are programs that are so closely integrated with a weapon system that their primary function is to provide immediate-use targeting data.) (JP 1-02)

intelligence report—A specific report of information, usually on a single item, made at any level of command in tactical operations and disseminated as rapidly as possible in keeping with the timeliness of the information. Also called INTREP. (JP 1-02)

intelligence reporting—The preparation and conveyance of information by any means. More commonly, the term is restricted to reports as they are prepared by the collector and as they are transmitted by the collector to the latter's headquarters and by this component of the intelligence structure to one or more intelligence-producing components. Thus, even in this limited sense, reporting embraces both collection and dissemination. The term is applied to normal and specialist intelligence reports. (JP 1-02)

intelligence requirement—Any subject, general or specific, upon which there is a need for the collection of information, or the production of

intelligence. Also called IR. (JP 1-02) In Marine Corps usage, questions about the enemy and the environment, the answers to which a commander requires to make sound decisions. (MCRP 5-12C)

interpretation—A part of the analysis and production phase in the intelligence cycle in which the significance of information is judged in relation to the current body of knowledge. See also intelligence cycle. (JP 1-02)

joint force—A general term applied to a force composed of significant elements, assigned or attached, of two or more Military Departments, operating under a single joint force commander. (JP 1-02)

joint force commander—A general term applied to a combatant commander, subunified commander or joint task force commander authorized to exercise combatant command (command authority) or operational control over a joint force. Also called JFC. (JP 1-02)

joint intelligence—Intelligence produced by elements of more than one Service of the same nation. (JP 1-02)

joint intelligence center—The intelligence center of the combatant command headquarters. The joint intelligence center is responsible for providing and producing the intelligence required to support the combatant commander and staff, components, subordinate joint forces and elements, and the national intelligence community. Also called JIC. (JP 1-02)

Joint Worldwide Intelligence Communications System—The sensitive compartmented information portion of the Defense Information Systems Network. It incorporates advanced networking technologies that permit point-to-point or multipoint information exchange involving voice, text, graphics, data, and video teleconferencing. Also called JWICS. (JP 1-02)

landing area—1. That part of the operational area within which are conducted the landing operations of an amphibious force. It includes the

beach, the approaches to the beach, the transport areas, the fire support areas, the airspace occupied by close supporting aircraft, and the land included in the advance inland to the initial objective. **2.** (Airborne) The general area used for landing troops and materiel either by airdrop or air landing. This area includes one or more drop zones or landing strips. **3.** Any specially prepared or selected surface of land, water, or deck designated or used for takeoff and landing of aircraft. (JP 1-02)

landing beach—That portion of a shoreline usually required for the landing of a battalion landing team. However, it may also be that portion of a shoreline constituting a tactical locality (such as the shore of a bay) over which a force larger or smaller than a battalion landing team may be landed. (JP 1-02)

liaison—That contact or intercommunication maintained between elements of military forces or other agencies to ensure mutual understanding and unity of purpose and action. (JP 1-02)

main effort—The designated subordinate unit whose mission at a given point in time is most critical to overall mission success. It is usually weighted with the preponderance of combat power and is directed against a center of gravity through a critical vulnerability. (MCRP 5-12C)

maintenance levels—The categories of maintenance and corresponding echelons of maintenance are organizational (first and second echelons), intermediate (third and fourth echelons), and depot (fifth echelon). (MCO 4790.2C)

maneuver warfare—A warfighting philosophy that seeks to shatter the enemy's cohesion through a variety of rapid, focused, and unexpected actions which create a turbulent and rapidly deteriorating situation with which the enemy cannot cope. (MCRP 5-12C)

Marine air-ground task force—The Marine Corps principal organization for all missions across the range of military operations, composed of forces task-organized under a single

commander capable of responding rapidly to a contingency anywhere in the world. The types of forces in the Marine air-ground task force (MAGTF) are functionally grouped into four core elements: a command element, an aviation combat element, a ground combat element, and a combat service support element. The four core elements are categories of forces, not formal commands. The basic structure of the Marine air-ground task force never varies, though the number, size, and type of Marine Corps units comprising each of its four elements will always be mission dependent. The flexibility of the organizational structure allows for one or more subordinate MAGTFs, to be assigned. Also called MAGTF. (JP 1-02)

Marine Corps Planning Process—A six-step methodology which helps organize the thought processes of the commander and staff throughout the planning and execution of military operations. It focuses on the threat and is based on the Marine Corps philosophy of maneuver warfare. It capitalizes on the principle of unity of command and supports the establishment and maintenance of tempo. The six steps consist of mission analysis, course of action development, course of action analysis, comparison/decision, orders development, and transition. Also called MCPP. NOTE: Tenets of the MCPP include top down planning, single battle concept, and integrated planning. (MCRP 5-12C)

Marine expeditionary force—The largest Marine air-ground task force (MAGTF) and the Marine Corps principal warfighting organization, particularly for larger crises or contingencies. It is task-organized around a permanent command element and normally contains one or more Marine divisions, Marine aircraft wings, and Marine force service support groups. The Marine expeditionary force is capable of missions across the range of military operations, including amphibious assault and sustained operations ashore in any environment. It can operate from a sea base, a land base or both. Also called MEF. (JP 1-02)

Marine expeditionary unit—A Marine air-ground task force (MAGTF) that is constructed around an infantry battalion reinforced, a helicopter squadron reinforced, and a task-organized combat service support element. It normally fulfills Marine Corps forward sea-based deployment requirements. The Marine expeditionary unit provides an immediate reaction capability for crisis response and is capable of limited combat operations. Also called MEU. (JP 1-02)

Marine expeditionary unit (special operations capable)—The Marine Corps standard, forward-deployed, sea-based expeditionary organization. The MEU(SOC) is a Marine expeditionary unit, augmented with selected personnel and equipment, that is trained and equipped with an enhanced capability to conduct amphibious operations and a variety of specialized missions, of limited scope and duration. These capabilities include specialized demolition, clandestine reconnaissance and surveillance, raids, in-extremis hostage recovery, and enabling operations for follow-on forces. The MEU(SOC) is not a special operations force but, when directed by the National Command Authorities, the combatant commander, and/or other operational commander, may conduct limited special operations in extremis, when other forces are inappropriate or unavailable. It may also contain other Service or foreign military forces assigned or attached to the Marine air-ground task force. Also called MEU (SOC). (JP 1-02)

measurement and signature intelligence—Scientific and technical intelligence obtained by quantitative and qualitative analysis of data (metric, angle, spatial, wavelength, time dependence, modulation, plasma, and hydromagnetic) derived from specific technical sensors for the purpose of identifying any distinctive features associated with the target, source, emitter, or sender measurement of the same. The detected feature may be either reflected or emitted. (JP 1-02)

multispectral imagery—The image of an object obtained simultaneously in a number of discrete spectral bands. (JP 1-02)

National Imagery Transmission Format Standard (NITFS)—The standard for formatting digital imagery and imagery-related products and exchanging them among members of the Intelligence Community as defined by the Executive Order 12333, the DOD, and other departments and agencies of the United States Government, as governed by Memoranda of Agreement (MOA) with those departments and agencies. (MIL-STD-2500A)

national intelligence—Integrated departmental intelligence that covers the broad aspects of national policy and national security, is of concern to more than one department or agency, and transcends the exclusive competence of a single department or agency. (JP 1-02)

near real time—Pertaining to the timeliness of data or information which has been delayed by the time required for electronic communication and automatic data processing. This implies that there are no significant delays. (JP 1-02)

open source intelligence—Information of potential intelligence value that is available to the general public. Also called OSINT. (JP 1-02)

operational control—Transferable command authority that may be exercised by commanders at any echelon at or below the level of combatant command. Operational control is inherent in combatant command (command authority). Operational control may be delegated and is the authority to perform those functions of command over subordinate forces involving organizing and employing commands and forces, assigning tasks, designating objectives, and giving authoritative direction necessary to accomplish the mission. Operational control includes authoritative direction over all aspects of military operations and joint training necessary to accomplish missions assigned to the command. Operational control should be exercised through the commanders of subordinate organizations. Normally this authority

is exercised through subordinate joint force commanders and Service and/or functional component commanders. Operational control normally provides full authority to organize commands and forces and to employ those forces as the commander in operational control considers necessary to accomplish assigned missions. Operational control does not, in and of itself, include authoritative direction for logistics or matters of administration, discipline, internal organization or unit training. Also called OPCON. (JP 1-02)

order of battle—The identification, strength, command structure, and disposition of the personnel, units, and equipment of any military force. Also called OOB. (JP 1-02)

photogrammetry—The science or art of obtaining reliable measurements from photographic images. (JP 1-02)

priority intelligence requirements—Those intelligence requirements for which a commander has an anticipated and stated priority in his task of planning and decisionmaking. Also called PIR. (JP 1-02) In Marine Corps usage, an intelligence requirement associated with a decision that will critically affect the overall success of the command's mission. (MCRP 5-12C)

production management—Encompasses determining the scope, content, and format of each intelligence product, developing a plan and schedule for the development of each product, assigning priorities among the various production requirements, allocating processing, exploitation, and production resources, and integrating production efforts with intelligence collection and dissemination. (MCRP 5-12C)

radar imagery—Imagery produced by recording radar waves reflected from a given target surface. (JP 1-02)

reach back—The ability to exploit resources, capabilities, expertise, etc. not physically located in the theater or a joint operations area, when established. (MCRP 5-12C)

rear area—For any particular command, the area extending forward from its rear boundary to the rear of the area assigned to the next lower level of command. This area is provided primarily for the performance of support functions. (JP 1-02)

rules of engagement—Directives issued by competent military authority which delineate the circumstances and limitations under which United States forces will initiate and/or continue combat engagement with other forces encountered. Also called ROE. (JP 1-02)

safe area—A designated area in hostile territory that offers the evader or escapee a reasonable chance of avoiding capture and of surviving until he can be evacuated. (JP 1-02)

sanitize—To revise a report or other document in such a fashion as to prevent identification of sources, or of the actual persons and places with which it is concerned, or of the means by which it was acquired. Usually involves deletion or substitution of names and other key details. (JP 1-02)

sensitive compartmented information—All information and materials bearing special community controls indicating restricted handling within present and future community intelligence collection programs and their end products for which community systems of compartmentation have been or will be formally established. (These controls are over and above the provisions of DOD 5200.1-R, Information Security Program Regulation.) Also called SCI. (JP 1-02)

sensor data—Data derived from sensors whose primary mission is surveillance or target acquisition, such as air surveillance radars, counterbattery radars, and remote ground sensors. (MCRP 5-12C)

signals intelligence—**1.** A category of intelligence comprising either individually or in combination all communications intelligence, electronic intelligence, and foreign instrumentation signals intelligence, however transmitted. **2.** Intelligence derived from communications,

electronics, and foreign instrumentation signals. Also called SIGINT. (JP 1-02)

situational awareness—Knowledge and understanding of the current situation which promotes timely, relevant, and accurate assessment of friendly, enemy, and other operations within the battlespace in order to facilitate decisionmaking. An informational perspective and skill that foster an ability to determine quickly the context and relevance of events that are unfolding. Also called SA. (MCRP 5-12C)

source—**1.** A person, thing, or activity from which information is obtained. **2.** In clandestine activities, a person (agent), normally a foreign national, in the employ of an intelligence activity for intelligence purposes. **3.** In interrogation activities, any person who furnishes information, either with or without the knowledge that the information is being used for intelligence purposes. In this context, a controlled source is in the employment or under the control of the intelligence activity and knows that the information is to be used for intelligence purposes. An uncontrolled source is a voluntary contributor of information and may or may not know that the information is to be used for intelligence purposes. (JP 1-02)

special operations—Operations conducted by specially organized, trained, and equipped military and paramilitary forces to achieve military, political, economic or informational objectives by unconventional military means in hostile, denied or politically sensitive areas. These operations are conducted across the full range of military operations, independently or in coordination with operations of conventional, non-special operations forces. Political-military considerations frequently shape special operations, requiring clandestine, covert, or low visibility techniques and oversight at the national level. Special operations differ from conventional operations in degree of physical and political risk, operational techniques, mode of employment, independence from friendly support, and dependence on detailed

operational intelligence and indigenous assets. Also called SO. (JP 1-02)

special purpose Marine air-ground task force—A Marine air-ground task force organized, trained and equipped with narrowly focused capabilities. It is designed to accomplish a specific mission, often of limited scope and duration. It may be any size, but normally it is a relatively small force—the size of a Marine expeditionary unit or smaller. It may contain other Service or foreign military forces assigned or attached to the Marine air-ground task force. Also called SPMAGTF. (JP 1-02)

split base—Two or more portions of the same force conducting or supporting operations from separate physical locations. (MCRP 5-12C)

surveillance—The systematic observation of aerospace, surface or subsurface areas, places, persons, or things, by visual, aural, electronic, photographic or other means. (JP 1-02)

sustained operations ashore—The employment of Marine Corps forces on land for an extended duration. It can occur with or without sustainment from the sea. Also called SOA. (MCRP 5-12C)

synthetic aperture radar—A radar in which a synthetically long apparent or effective aperture is constructed by integrating multiple returns from the same ground cell, taking advantage of the Doppler effect to produce a phase history film or tape that may be optically or digitally processed to reproduce an image. (MIL-HDBK-850)

tactical intelligence—Intelligence that is required for planning and conducting tactical operations. (JP 1-02) In Marine Corps usage, tactical intelligence is concerned primarily with the location, capabilities, and possible intentions of enemy units on the battlefield and with the tactical aspects of terrain and weather within the battlespace. (MCRP 5-12C)

tactical warning—**1.** A warning after initiation of a threatening or hostile act based on an evaluation of information from all available sources.

2. In satellite and missile surveillance, a notification to operational command centers that a specific threat event is occurring. The component elements that describe threat events are: Country of origin-country or countries initiating hostilities. Event type and size-identification of the type of event and determination of the size or number of weapons. Country under attack-determined by observing trajectory of an object and predicting its impact point. Event time-time the hostile event occurred. Also called integrated tactical warning. (JP 1-02)

target—1. A geographical area, complex or installation planned for capture or destruction by military forces. **2.** In intelligence usage, a country, area, installation, agency or person against which intelligence operations are directed. **3.** An area designated and numbered for future firing. **4.** In gunfire support usage, an impact burst which hits the target. (JP 1-02)

target intelligence—Intelligence which portrays and locates the components of a target or target complex and indicates its vulnerability and relative importance. (JP 1-02)

technical control—The performance of specialized or professional service or the exercise of professional guidance or direction through the establishment of policies and procedures. (Proposed USMC definition for next revision of MCRP 5-12C.)

terrain intelligence—Intelligence on the military significance of natural and manmade characteristics of an area. (JP 1-02)

unconventional warfare—A broad spectrum of military and paramilitary operations, normally of

long duration, predominantly conducted by indigenous or surrogate forces who are organized, trained, equipped, supported, and directed in varying degrees by an external source. It includes guerrilla warfare and other direct offensive, low visibility, covert or clandestine operations, as well as the indirect activities of subversion, sabotage, intelligence activities, and evasion and escape. Also called UW. (JP 1-02)

validation—A process normally associated with the collection of intelligence that provides official status to an identified requirement and confirms that the requirement is appropriate for a given collector and has not been previously satisfied. (JP 1-02)

warfighting functions—The six mutually supporting military activities integrated in the conduct of all military operations are:

1. command and control—The means by which a commander recognizes what needs to be done and sees to it that appropriate actions are taken.

2. maneuver—The movement of forces for the purpose of gaining an advantage over the enemy.

3. fires—Those means used to delay, disrupt, degrade or destroy enemy capabilities, forces or facilities as well as affect the enemy's will to fight.

4. intelligence—Knowledge about the enemy or the surrounding environment needed to support decisionmaking.

5. logistics—All activities required to move and sustain military forces.

6. force protection—Actions or efforts used to safeguard own centers of gravity while protecting, concealing, reducing or eliminating friendly critical vulnerabilities.

Also called WF. (MCRP 5-12C)

APPENDIX O. REFERENCES AND RELATED PUBLICATIONS

Presidential Executive Orders

- 12333 United States Intelligence Activities
- 12334 President's Intelligence Oversight Board

Director of Central Intelligence Directives (DCIDs)

- 1/14 Personnel Security Standards and Procedures Governing Eligibility for Access to Sensitive Compartmented Information
- 1/16 Security Policy for Uniform Protection of Intelligence Processed in Automated Information Systems and Networks
- 1/21 Physical Security Standards for Sensitive Compartmented Information Facilities (SCIF)

Department of Defense Directives (DODDs)

- 5040.5 Alteration of Official DoD Imagery
- 5200.1 DoD Information Security Program
- 5240.1 DoD Intelligence Activities

Department of Defense (DOD) Manuals

- 5105.21-M-1 Sensitive Compartmented Information (SCI) Administrative Security Manual
- 5240.1-R Procedures Governing the Activities of DoD Intelligence Components that Affect United States Persons

Department of Defense (DOD) Publications

- TS-5105.21-M-2 Sensitive Compartmented Information (SCI) Security Manual, Communications Intelligence (COMINT) Policy
- TS-5105.21-M-3 Sensitive Compartmented Information (SCI) Security Manual, TK Policy

Defense Intelligence Agency Manuals (DIAMs)

- 50-4 Department of Defense Intelligence Information System (DODIIS) Information Systems Security (INFOSEC) Program

58-5 Imagery Requirements (U) SECRET/US ONLY SAO Supplement
R 50-7 Department of Defense Exploitation of Multisensor Imagery

Joint Publications (JPs)

1-02 Department of Defense Dictionary of Military and Associated Terms
2-0 Doctrine for Intelligence Support to Joint Operations
2-01 Joint Intelligence Support to Military Operations
2-02 National Intelligence Support to Joint Operations
2-03 Joint Tactics, Techniques, and Procedures for Geospatial
Information and Services Support to Joint Operations
3-02 Joint Doctrine for Amphibious Operations
3-13.1 Joint Doctrine for Command and Control Warfare (C2W)
3-54 Joint Doctrine for Operations Security
5-0 Doctrine for Planning Joint Operations
6-0 Doctrine for C4 Systems Support to Joint Operations

Marine Corps Doctrinal Publications (MCDPs)

1 Warfighting
2 Intelligence
3 Expeditionary Operations
4 Logistics
5 Planning
6 Command and Control

Marine Corps Warfighting Publications (MCWPs)

2-1 Intelligence Operations
2-12 MAGTF Intelligence Production and Analysis
2-12.1 Geographic Intelligence
2-15.2 Signals Intelligence
3-40.3 Communications and Information Systems

Marine Corps Reference Publications (MCRPs)

- 5-12C Marine Corps Supplement to the Department of Defense Dictionary of Military and Associated Terms
- 5-12D Organization of Marine Corps Forces

Fleet Marine Force Reference Publication (FMFRP)

- 5-71 MAGTF Aviation Planning Documents

Marine Corps Order (MCO)

- 3500.32 Intelligence Training and Readiness Manual

U.S. Army Field Manuals (FMs)

- 34-2 Collection Management and Synchronization Planning
- 34-130 Intelligence Preparation of the Battlefield (IPB)

Miscellaneous

- Joint Tactical Exploitation of National Systems (JTENS) Manual
- Imagery System Overview (IMSO)
- National Imagery System User's Guide (NIMSUG)
- National Imagery Interpretability Rating Scale (NIIRS)
- National Imagery and Mapping Agency Imagery Policy Series (Sections 1-9)